

Special Board of Education Meeting

Tuesday, April 28, 2026 12:00 PM

Gering Public Schools - Central Office, 1519 10th St, Gering,
NE 69341



Agenda

1. GPS Board of Education Information

The meeting agenda will be kept current and available for public inspection in the office of the Secretary of the Board of Education at the Central Office during regular working hours.

District Vision: *Gering Public Schools provides a collaborative community, inspiring excellence and innovation in teaching and learning to empower student growth and leadership in school and life.*

District Mission: *Gering Public Schools exists to equip today's learners with the skills necessary to be tomorrow's leaders.*

The Open Meetings Act requires and the intention of the Board is that agenda items be sufficiently descriptive to give the public reasonable notice of matters to be considered at the meeting. The Board of Education releases its agenda well in advance of most meetings and desires that all interested persons are fully informed. Any interested person who has a question or needs clarification about the sufficiency of a descriptive item should contact the office of the Superintendent of Schools.

Agenda items are subject to reordering at the discretion of the board president. Board members may request specific agenda item(s) be moved to a different place on the agenda. Please attend the entire meeting to ensure you hear discussion on a particular agenda item.

2. Opening Procedures

2.1. Call to Order

The Board of Education reserves the right to enter into Executive Session for the protection of the public interest; or the prevention of needless injury to the reputation of an individual, and if the individual has not requested a public meeting.

2.2. Roll Call

2.3. Open Meetings Act

Pursuant to Section 84-1412 of the Nebraska Statutes, the public is hereby informed that a current copy of the Nebraska Open Meetings Act is posted in the Board meeting room on the north wall.

Notice of this meeting was published in the Star Herald on Thursday, April 23rd, 2026.

3. **Action Items**

3.1. Discuss, consider, and take action to amend the 2026-27 contract between Interim Superintendent, Dr. Kory Knight, and Gering Public Schools.

3.2. Discuss, consider, and take action to approve the auditorium lighting proposal from Voss Lighting, for the amount of \$159,600.

3.3. Discuss, consider, and take action to approve the seven-year Science Curriculum adoption in the amount of \$252,110.64 and the seven-year Spanish and German Curriculum adoption in the amount of \$28,571.77.

4. **Public Comment: Policy 204.12**

5. **Adjourn**

INTERIM SUPERINTENDENT'S CONTRACT OF EMPLOYMENT GERING PUBLIC SCHOOLS

THIS CONTRACT is made by and between the **Board of Education of Gering Public Schools**, legally known as **Scotts Bluff County School District 79-0016**, and referred to as "the Board" and "the District" respectively, and **Dr. Kory Knight**, referred to herein as "the Interim Superintendent". In accordance with its action taken and recorded in the minutes of a duly advertised board meeting, the Board agrees to employ the Interim Superintendent, and the Interim Superintendent agrees to accept such employment, subject to the terms and conditions set forth herein.

Section 1. Term of Contract. The Interim Superintendent shall be employed for a period of one year beginning on July 1, 2026, and expiring on June 30, 2027. This contract is entered into for the sole purpose of employing the Interim Superintendent for the period specified above. It shall not be subject to renewal by statute or any provision of this contract. During this contract, the Interim Superintendent shall be employed with the District on a 1.0 FTE basis. References to "contract year" shall mean the period from July 1st through June 30th. The Interim Superintendent's generally expected working days shall consist of all days Monday through Friday, but generally not Saturdays and Sundays and any holidays or leave days listed in Section 11. However, the Interim Superintendent will work all days necessary to complete the Interim Superintendent's duties, even if those are weekend days or holidays. The Interim Superintendent shall keep complete and accurate records of working days and shall provide the Board of Education with a report of the accumulated working days at least quarterly.

Section 2. No Renewal of Contract. IT IS A MATERIAL PROVISION OF THIS CONTRACT THAT IT IS FOR A LIMITED PERIOD OF TIME AND SHALL NOT BE SUBJECT TO THE RENEWAL OR NONRENEWAL PROVISIONS OF NEB. REV. STAT. §§ 79-824 TO 79-839 OR §§ 79-846 TO 79-849. IN EXCHANGE FOR **\$1 OF THE SALARY PROVIDED BELOW** AND OTHER VALUABLE CONSIDERATION, THE INTERIM SUPERINTENDENT AGREES TO ACCEPT EMPLOYMENT AS INTERIM SUPERINTENDENT ON THIS BASIS AND HEREBY RESIGNS THE POSITION OF INTERIM SUPERINTENDENT AS OF THE EXPIRATION DATE SET OUT ABOVE. BY RESIGNING AND ACCEPTING THIS ADDITIONAL CONSIDERATION, THE INTERIM SUPERINTENDENT UNDERSTANDS THAT HE OR SHE IS WAIVING STATUTORY RIGHTS SUCH AS TO NOTICE AND A HEARING AND OTHER RIGHTS REGARDING NONRENEWAL OF EMPLOYMENT IN THE POSITION OF INTERIM SUPERINTENDENT. THE INTERIM SUPERINTENDENT DOES SO VOLUNTARILY AND WITH FULL KNOWLEDGE OF THE RIGHTS WAIVED. For clarity, the Parties agree that the scope of the resignation stated in this Section 2 is limited to the Interim

Superintendent resigning from the position of Interim Superintendent and does not constitute a resignation of the Interim Superintendent's employment with the District in all capacities. The Parties expressly agree that in the event that the Interim Superintendent ceases serving in the role of Interim Superintendent at the end of the 2026–2027 contract year as contemplated herein yet remains employed by the District for the 2027–2028 contract year, then (a) the Interim Superintendent may not necessarily return to the position of Director of Curriculum & Assessment, it being expressly understood that the Interim Superintendent's position for the 2027–2028 school year will be assigned by the District's Superintendent subject to the approval of the Board of Education; and (b) the Interim Superintendent's contractual compensation and fringe benefits for the 2027–2028 contact year will be no less than the contractual compensation and fringe benefits to which the Interim Superintendent was entitled in the position of Director of Curriculum & Assessment for the 2025–2026 contract year. The Interim Superintendent shall be responsible for taking all necessary steps to ensure that the District has complied with the Superintendent Pay Transparency Act.

Section 3. Salary. The Interim Superintendent's salary for the contract year shall be \$175,000.00, which shall be paid in 12 equal monthly installments consistent with the District's regular payroll periods. The Board shall not reduce the Interim Superintendent's salary during the term of the contract, but may increase it and/or the benefits during the term of this contract, as an amendment to the contract, without the amendment constituting a new contract, requiring a hearing, or extending the term of this contract.

Section 4. Deductions. This contract shall conform to the statutes and regulations governing deductions from compensation and shall be subject to the School Employees Retirement Act. The Interim Superintendent authorizes the District to deduct or withhold from each and every period of pay any amounts necessary to offset any damages caused by the Interim Superintendent or the value of property or money entrusted to the Interim Superintendent or owed by the Interim Superintendent to the District during the course of or as a result of the Interim Superintendent's employment, if such property or money have not properly been returned to the District. The District shall withhold other deductions as the Interim Superintendent and Board may agree.

Section 5. Professional Status. The Interim Superintendent affirms that the Interim Superintendent is not under contract with any other board of education covering any part or all of the term provided in this contract. Throughout the contract term, the Interim Superintendent will hold a valid and appropriate certificate to act as a superintendent of schools in the State of

Nebraska which the Interim Superintendent will register and maintain on file in the District's central administrative office. This contract shall not be valid and the Board will not compensate the Interim Superintendent for any service performed prior to the date that the Interim Superintendent registers the certificate. The Interim Superintendent represents that: (1) all information provided in connection with the Interim Superintendent's application for employment with the District was true and accurate at the time of application, and if there is or has been a material change in such information, the Interim Superintendent will advise the Board immediately; (2) the Interim Superintendent has never been convicted of or plead no contest to a felony as defined in Title 92, Chapter 21, Sections 003.11 and 003.13 of the Nebraska Administrative Code ("Rule 21"), or any offense involving moral turpitude, abuse, neglect, or sexual misconduct, as defined in Title 92, Chapter 21, Sections 003.12 and 003.13 of the Nebraska Administrative Code; and (3) the Interim Superintendent has not had any professional licenses or certificates suspended or revoked.

Section 6. Interim Superintendent's Duties. The Interim Superintendent's duties shall be as prescribed by statute and by Board policies, rules, regulations and directives. The Interim Superintendent agrees to devote the Interim Superintendent's time, skill, labor and attention to all required duties throughout the contract term. The Interim Superintendent shall be subject to the direction and control of the Board at all times and shall perform such administrative duties as the Board assigns. By agreement with the Board, the Interim Superintendent may undertake consultative work, speaking engagements, writing, lecturing, or other professional duties and obligations as long as they do not interfere with carrying out the Interim Superintendent's duties and obligations to the District.

Section 7. Board-Interim Superintendent Relationship. The Board shall be primarily responsible for formulating and adopting policy. The Interim Superintendent shall be the chief administrative officer for the District and shall be responsible for implementing Board policy. The Interim Superintendent shall organize the administrative and supervisory staff, and select, place, and transfer personnel with the concurrence of the Board. The Interim Superintendent is responsible for administering the instruction of students and the business affairs of the District. The Board members agree, individually and collectively, to promptly refer all criticisms, complaints, and suggestions called to their attention to the Interim Superintendent for action, study and/or recommendation, as appropriate.

Section 8. Cancellation or Mid-Term Amendment. The Board may cancel or amend this contract during its term for any of the following reasons: (a) the cancellation, termination, revocation, or suspension of the Interim

Superintendent's certificate (Nebraska Administrative and Supervisory Certificate, or the Nebraska Professional Administrative and Supervisory Certificate) by the State Board of Education: (b) any of the reasons set forth in this contract; (c) the breach of any of the material provisions of this contract; (d) incompetence; (e) neglect of duty; (f) unprofessional conduct; (g) insubordination; (h) conduct involving moral turpitude; (i) physical or mental incapacity; (j) immorality; (k) conviction of a felony; (l) any conduct that substantially interferes with the Interim Superintendent's continued performance of the Interim Superintendent's duties; (m) any arrest, criminal charge, or criminal conviction of Interim Superintendent or the failure to report the same; (n) any filing against the Interim Superintendent under NEB. REV. STAT. § 43-247 or any other provision of the Nebraska Juvenile Code for child abuse and/or neglect or the failure to report the same; (o) knowingly falsifying District records or documents; (p) misrepresentation of fact to the District and its personnel in the conduct of its official business; (q) the use or possession of illegal drugs or controlled substances except as prescribed by a physician; or (r) being under the influence of illegal drugs, controlled substances, or alcohol while on school grounds, at school events, or in a vehicle owned, leased or contracted by the District except as prescribed by a physician. The procedures for cancellation or amendment shall be in accordance with state statutes. The parties agree at the outset of this contract that in addition to any other material breaches, the Interim Superintendent's failure to comply with the obligations in the Term, Renewal, and/or Evaluation provisions of this contract shall constitute a material breach of this contract.

Section 9. Disability. If the Interim Superintendent is unable to perform any of the Interim Superintendent's duties by reason of illness, accident or other disability beyond the Interim Superintendent's control, and the disability continues for a period of more than sixty (60) days, or if the disability is permanent, irreparable, or of such a nature as to make performance of the Interim Superintendent's duties impossible, the Board may initiate action to cancel this contract, whereupon the respective rights, duties and obligations of the parties hereunder shall terminate, with the exception of any benefits to be paid to the Interim Superintendent under any insurance coverage furnished by the District.

Section 10. Transportation. The Board shall provide the Interim Superintendent with transportation or reimburse the Interim Superintendent for mileage required in the performance of official duties at the then-current IRS rate.

Section 11. Fringe Benefits. The Board shall provide the Interim Superintendent with the following fringe benefits:

- a. Health Insurance.** The District shall pay the full cost of the annual single health insurance premium with dental at the \$1,050 deductible premium level pursuant to the Educator Health Alliance schedule.
- b. Life Insurance.** The District shall pay 50% of the premium of one of the life insurance plans offered by the District if the Superintendent elects to enroll. Currently, those offerings include policies with total death benefits of \$20,000, \$40,000, or \$60,000.
- c. Sick Leave.** The Interim Superintendent shall be entitled to ten (10) days of sick leave per year which may accumulate to a total of sixty-six (66) days. Nothing herein shall be construed to eliminate any accumulated unused sick leave that the Interim Superintendent has accrued prior to the beginning of this agreement. Sick leave may only be used for personal illness or as otherwise provided in District policy. If the Interim Superintendent qualifies for disability pay under the long-term disability policy, the Interim Superintendent shall be required to take the disability pay instead of sick leave pay. The Interim Superintendent shall keep complete and accurate records of sick days accrued and used and shall provide the Board with a report of accumulated sick days at least quarterly and upon request. The Interim Superintendent shall not be compensated for unused days of sick leave upon the ending of employment with the District.
- d. Disability Insurance.** The Interim Superintendent shall purchase long-term disability insurance from the District's carrier at the Interim Superintendent's own expense. The amount of the premium for the Interim Superintendent's long-term disability insurance will be added to the Interim Superintendent's gross pay each month.
- e. Section 125 Plan.** The Interim Superintendent may participate in the District's Section 125 plan consistent with the terms of that plan. Any contributions will be directed by the Interim Superintendent. The Board does not contribute

toward the Interim Superintendent's participation in the plan.

- f. Vacation.** The Interim Superintendent shall have twenty (20) vacation days for the initial contract year which the Interim Superintendent may use at times the Interim Superintendent chooses so long as the absence does not interfere with the proper performance of the Interim Superintendent's duties. Any extended vacation period while school is in session will require advance approval by the Board, and the parties will cooperate in arranging vacation time so as to cause the least inconvenience to the normal operation of the District. If the parties choose to renew or otherwise extend the term of this agreement beyond the term stated above—or in the event that the Interim Superintendent remains employed by the District in another position—then after the initial contract year, the Board shall give the Superintendent the number of vacation days necessary to restore the total to twenty (20) days. For example, if the Interim Superintendent uses 12 days of vacation one year, the Board will provide the Interim Superintendent with 12 days the following year to bring the total vacation days back to 20. The Interim Superintendent shall develop a system for recording use of vacation days and shall keep such records current and on file in the District's central office. The Interim Superintendent shall keep complete and accurate records of all vacation days and shall provide the Board of Education with a report of accumulated vacation days at least quarterly and upon request. The Board may require the Interim Superintendent to use vacation days and shall compensate the Interim Superintendent for unused vacation days upon the conclusion of employment at a rate of \$100.00 per day.
- g. Professional Development.** The Interim Superintendent is expected to continue and seek professional development and to participate in relevant learning experiences. With the approval of the Board, the Interim Superintendent may attend appropriate professional meetings at the local, state, regional and national level; and the Board will pay for valid expenses of attendance.

- h. Professional Dues.** The District will pay the annual dues for the Interim Superintendent's membership in the following organizations: Nebraska Council of School Administrators (NCSA); American Association of School Administrators (AASA).
- i. Physical Examination.** The Interim Superintendent may voluntarily undergo a physical examination. The Interim Superintendent agrees to authorize the physician performing each such examination to provide the Board with all records, results and medical judgments of the examination. Up to \$250.00 of the cost of such physical examination and physician's reports which are not paid for by the Interim Superintendent's insurance coverage shall be paid by the District.
- j. Bereavement Leave.** The Interim Superintendent is entitled to a total of five (5) bereavement leave days per year, which must be taken consecutively, for absence in case of a death in the Interim Superintendent's immediate family. Immediate family is defined as the Interim Superintendent's spouse, parent, mother-in-law, father-in-law, child, step-child, daughter-in-law, son-in-law, sibling, sister-in-law, brother-in-law, grandchild, grandparent, a person who resides in the Interim Superintendent's home as part of the Interim Superintendent's family, or someone for whom the Interim Superintendent is guardian or serves as power of attorney. For the death of the Interim Superintendent's child, step-child, or spouse, the Interim Superintendent may take up to an additional five (5) days of bereavement leave that will be deducted from the Interim Superintendent's available sick leave.
- k. Holidays.** The Interim Superintendent shall receive the following holidays off without loss of pay or having to take a paid leave day: New Year's Day, Good Friday, Memorial Day, Fourth of July, Labor Day, Thanksgiving Day, the day after Thanksgiving, Christmas Eve, Christmas Day, and New Year's Eve.
- l. Cell Phone.** The Interim Superintendent shall be required to purchase and maintain a cellular phone so that the Interim Superintendent can be reached at all times for work-related emergencies or while away from school

grounds during the work day. The District will reimburse the Interim Superintendent up to a maximum of \$100 per month for the actual cost of a cellular phone service plan.

m. Expense Reimbursement. The Board shall pay or reimburse the Interim Superintendent for expenses that are actually, necessarily, and reasonably incurred in attending educational seminars, conventions, and workshops; conferences; training programs; official school functions, hearings or meetings, provided that (1) such payment or expense is authorized by the Local Government Miscellaneous Expenditures Act (NEB. REV. STAT. § 13-2201 *et seq.*) or some other provision of law, and (2) the Interim Superintendent shall secure the prior approval of the Board before incurring any such expense when the anticipated aggregate expense of any single event is \$1,500.00 or more.

Section 12. No Penalty for Release or Resignation. There shall not be a penalty for the release or resignation of the Interim Superintendent from this contract; provided no resignation shall become effective until the expiration of the contract unless it is accepted by the Board, and the Board shall fix the date at which the resignation shall take effect.

Section 13. Compensation Upon Termination and Credit for Accrued Vacation. Upon lawful termination of this contract for any reason, the compensation to be paid hereunder shall be an amount which bears the same ratio to the annual salary specified as the number of months or fraction thereof to the date of such termination bears to the 12 months in the annual salary period in which termination occurs. The Interim Superintendent shall refund any portion of the salary paid but not earned prior to the date of termination of this contract.

Section 14. Evaluation. The Board shall evaluate the Interim Superintendent twice during the Interim Superintendent's first year of employment and at least once each year thereafter, if any. The first evaluation during the first year of employment and the yearly evaluations after the first year of employment shall occur no later than the **regular December meeting**. The Interim Superintendent shall: remind the Board members in writing of this provision no later than its **regular November meeting**; make the Interim Superintendent evaluation an agenda item for the regular **December** Board meeting during each year of this contract; and provide the Board members with the written evaluation instrument that is on file with the Nebraska Department of Education.

Section 15. Legal Actions. The Board will support the Interim Superintendent if there is a legal dispute caused by carrying out the Interim Superintendent's duties properly. If a legal action, including a professional practice complaint, is threatened or filed against the Interim Superintendent as a result of the Interim Superintendent's performance of duties or position as the Interim Superintendent of the District, the Board will provide the Interim Superintendent with a legal defense to the maximum extent permitted by law so long as the Interim Superintendent acted in good faith and in a manner which the Interim Superintendent reasonably believed to be in or not opposed to the best interests of the District and, with respect to any criminal action or proceeding, had no reasonable cause to believe that the Interim Superintendent's conduct was unlawful.

Section 16. Physical or Mental Examination. The Interim Superintendent agrees that, at the request of the Board, the Interim Superintendent will have a comprehensive physical and/or mental examination performed by one or more licensed physicians or psychologists of the Board's choosing during the term of this contract. In deference to the requirements of state and federal law, the physician's report to the Board must address whether the Interim Superintendent is able to perform the "essential functions" of the position.

Section 17. Disciplinary Action. The parties agree that the Board president may place the Interim Superintendent on paid leave by delivering written notice of the same when the Board president determines it is in the best interests of the District to do so. The paid leave shall continue unless and until a majority of the Board determines otherwise at a duly convened meeting. The Board may suspend the Interim Superintendent without pay for a period not to exceed thirty (30) working days. Prior to suspending the Interim Superintendent without pay, the Board president or secretary shall deliver a written notice to the Interim Superintendent advising the Interim Superintendent of the alleged reasons for the proposed action and provided the opportunity to present the Interim Superintendent's version of the facts. Within seven calendar days after receipt of such notice, the Interim Superintendent may make a written request to the secretary of the school board for a due process hearing under NEB. REV. STAT. § 79-832. If such a request is not delivered within such time, the action of the Board shall become final.

Section 18. Governing Laws. The parties shall be governed by all applicable state and federal laws, rules, and regulations in performance of their respective duties and obligations under this contact.

Section 19. Amendments to be in Writing. This contract may be modified or amended only by a writing duly authorized and executed by the Interim Superintendent and the Board.

Section 20. Severability. If any portion of this contract is declared invalid or unenforceable by a court of competent jurisdiction, such declaration shall not affect the validity or enforcement of the remaining provisions of this contract.

Section 21. Entire Agreement. This contract fully incorporates the entire agreement and understanding of the Parties, and there are no other oral or written agreements or understandings in effect among the Parties, relating to the subject matter of this contract. This contract supersedes all prior statements, representations, or warranties, oral or written, express or implied, regarding the subject matter of this contract, including but not necessarily limited to the Interim Superintendent’s Contract of Employment for the 2026–2027 contract year between the Parties that was approved by the Board on April 13, 2026; and no promise, representation, or agreement not expressed in this contract has been made to any Party.

IN WITNESS WHEREOF, the parties have executed this contract on the dates indicated below.

Executed by the Board this ____ day of _____, 2026.

President, Board of Education

Secretary, Board of Education

Executed by the Interim Superintendent this ____ day of _____, 2026.

Interim Superintendent

VOSS

Specialists in Lighting Since 1939

1601 Cushman Drive
Lincoln, NE 68512
P: 402.328.2281
F: 402.328.2282

vosslighting.com



vosslighting.com

Gering High School

Auditorium Lighting

4/17/2026

Prepared by: Keenan Schmidt

keenan.schmidt@vosslighting.com

(402) 889-5858 Cell

This Price Quote is Omnia Partners Approved
Voss Lighting Contract #02-83

Data is proprietary and confidential

Voss Lighting

4624 S 140th St.
Omaha, NE 68137



Project Name

Gering Public Schools
1500 U St
Gering, NE 69341

Revised: 22 January, 2026

Scope of Work

Auditorium Downlights

- Remove fluorescent downlights and install LED downlights with fade to black capabilities with goof rings and make dimmable

Auditorium Cove

- Remove fluorescent strip fixtures and install RGB LED tape light

Auditorium Spot Lights

- Remove spot lights from each side and install LED spot lights

Additional:

- Install (1) paradigm touch screen
- Update the existing dimmer rack
- All lighting above to be controlled together
- All programming and commissioning is included



Gering Public Schools
Auditorium Lighting Retrofit

4/17/2026

Scope of Work

See Exhibit A Scope

Installation Considerations

Pricing is based on a normal Monday through Friday work week. Any additional work could result in a needed change order. Due to recent and possible future trade tariffs on imported goods and general price increases, all quotes are subject to change at the time of order being placed. This proposal does not include an engineering review or any and all upgrades to existing electrical installation(s).

Project Financials

Project Cost	\$	159,600.00
Less Estimated Rebates	\$	-
Net Project Cost	\$	159,600.00

How to get started

Project Cost	\$	159,600.00
Down Payment	\$	63,840.00

Mario Mammaia
402.889.5858
mario.mammaia@vossighting.com



VOSS QUOTATION TERMS AND CONDITIONS

ACCEPTANCE OF PROPOSAL AND PRIME CONTRACT:

1. **Prime Contract.** If Project Quotation is approved by Customer, Voss will then provide a prime contract for Customer signature. Alternatively, Customer may provide a prime contract for the amount per the Voss quotation.
Note: Voss quotation, or the quotation contents in their entirety, must be included as an integral part of a subsequent prime contract, purchase order, work directive, or other legal prime contractual agreement.
2. **Downpayment.** If the Voss Project Quotation contains a provision for a downpayment, the downpayment amount must be shown under payment terms in the prime contact.
3. Upon full execution of the prime contract and payment of the downpayment amount if required, product will be then ordered and installation scheduled.

PROJECT DELAYS AND CANCELLATIONS: Should the project be delayed beyond (10) ten days from original quotation date, the quotation shall be considered void. Upon request, Voss will review all pricing for any necessary adjustments related to material, expense, equipment, and labor costs, and other related costs and a quotation provided for Customer approval. Once under contract, should project be delayed or cancelled, Customer may be liable for any additional costs, including, product cancellation fees, restocking charges, freight charges, price increases, expended related costs, including but not limited to labor, expenses, and equipment charges.

PROJECT PRICE INCREASES: This quotation is based upon current product pricing and installation related costs. Quotation is guaranteed for (10) ten days from quotation date. After (10) ten days, our pricing will be reviewed for any necessary adjustments related to material, expense, equipment, labor and any and other related costs that may be affected by an extended approval period.

PRICE: Proposal includes all applicable taxes, fees, permit and inspection costs, as required.

PRODUCT NON-STOCK ITEMS: Some products that we offer are not stock items in our warehouse and are ordered as needed. Such items are 'special order' and have extended lead times and are non-returnable.

PRODUCT DELIVERY AND INSTALLATION DATES: Upon execution of the Voss contract or Customer provided prime contract, we will aggressively process and expedite your project. At that time, product delivery and onsite installation dates will be verified. Voss cannot accept responsibility for product production and shipping delays, delivery issues, and inclement weather that are beyond our control.

CLARIFICATIONS:

1. Our proposal is based on a normal 8-hour per day (40-hour per week) Monday through Friday work schedule and includes no provision for shift work or overtime.
2. Voss has included project related permit and inspection costs, If required by the Authority Having Jurisdiction.
3. **Our proposal does not include:**
 - a. The cost of performance, payment, and maintenance bonds. However, we will furnish these bonds, if desired, for an additional cost.
 - b. The scope of work within this document does not include any and all costs for demolition, replacement, repair, painting, and patching of existing interior and exterior walls, floors, ceilings, roofs and other interior and exterior surfaces, including above grade and below grade concrete and asphalt surfaces, and any components of acoustic ceilings, unless specifically stated otherwise in this proposal.
 - c. Costs associated with any and all hidden or unforeseen conditions and/or existing installation(s), including costs associated with corrective measures for existing installation(s) that may be required by Authority Having Jurisdiction. Among these conditions are, in part but not limited to, conditions existing above finished ceilings, under existing wall surfaces, below grade, conditions concealed by items or otherwise obstructed from view, and similar conditions.



EXISTING INSTALLATIONS.

Unless specifically noted otherwise, all existing electrical installation is assumed to be in good condition and compliant with the requirements of current National Fire Protection standards as follows: National Electrical Code (NFPA Standard 70), Standard for Electrical Safety in the Workplace (NFPA Standard 70E), Life Safety Code (Standard 101), along with all related standards and requirements including jurisdictional enforced Uniform Building Codes. Because our completed installation must be compliant with all recognized codes and regulations, if actual conditions are found to be different and/or non-compliant after proposal is submitted, Voss reserves the right to evaluate our pricing for cost impact(s) and associated price revision.

VOLTAGE.

Voss pricing is based on the assumed voltage at each fixture location being as stated in our proposal.

EMERGENCY EGRESS AND EXIT LIGHTING.

If project scope includes the removal and replacement of existing emergency egress and/or exit lighting, and unless stated otherwise in this document:

1. Our pricing includes the removal and replacement of existing emergency egress and exit lighting in its current location only.
2. Our pricing does not include any costs associated with design or evaluation of design of existing emergency egress routes and emergency egress illumination and exit lighting for compliance with codes, standards, and regulations required within the project jurisdiction. Design modifications and/or revisions must be completed by others and written direction provided to Voss for evaluation of cost impact, if any.
3. Voss strongly recommends Customer coordination with the Authority Having Jurisdiction and associated governmental agencies with jurisdiction over emergency egress routes, emergency egress illumination, and exit lighting within this facility, to verify and ensure compliance with associated codes, laws, requirements, and regulations. Voss has not included in this proposal, any and all coordination with or the costs associated with coordination with the Authority Having Jurisdiction and associated governmental agencies with jurisdiction over emergency egress, emergency egress illumination, and exit lighting within this facility. Voss assumes no liability for non-compliance of the same.

SUPPORT SYSTEMS.

Concerning new lighting products and appurtenances (collectively Lighting Systems) to be installed on existing lighting poles, concrete bases, anchoring systems, (collectively Support Systems); Voss has not included costs for engineering analysis, evaluation, and inspection of the existing Lighting Systems and/or Support Systems. Voss requires execution of 'Support Systems Directive' prior to execution of Contract Agreement or Notice To Proceed.

REBATES.

Because rebate rules vary between utility companies, Voss cannot fully guarantee that every energy-saving measure included in this proposal will qualify for a rebate. This will be confirmed upon the commencing of project and/or post project utility audit. The estimated rebate amount stated in review of project by Voss and/or information/counts shared with Voss by this proposal are a good-faith estimate based on Customer. Voss shall notify the Customer in writing of such differentials and will submit necessary documentation, showing the difference between the estimated and actual rebate amounts, required for contract adjustment.

UNFORSEEN PRICE ESCALATION.

In the event that, upon entering a contractual relationship with the Customer or during the performance of the project, unforeseen price escalation/increases in materials, labor, equipment, or other project related charges such as, but not limited to, domestic and/or foreign government imposed tariffs, increased freight and handling costs, and/or the price of commodity materials such as, but not limited to, steel, copper, aluminum, stainless steel, polyvinyl chloride (PVC), etc, as well as phosphors and other metals and/or precious metals and similar substances, and/or the price of components used in the manufacture of products provided by Voss as part of the work, significantly increases due to circumstances beyond the control of Voss, Voss will pursue and require equitable compensation/reimbursement of such increased costs for any and all items affected prior to release of order(s).



WARRANTY.

Voss warranty terms are as follows:

1. Voss warrants the Work (material and labor) against defects in materials and workmanship for a period of twelve (12) months from the date of substantial completion (the 'Initial Warranty Period').
2. In the event of a warranty event during the Initial Warranty Period, Customer is required to notify Voss in writing before the expiration of the Initial Warranty Period. Voss will respond within thirty (30) business days from the date the warranty claim is received.
3. In the event of a warranty event after Initial Warranty Period in which covered material is covered by a manufacturer warranty that extends beyond the Initial Warranty Period (the 'Extended Warranty Period) and upon timely notification from Customer prior to the expiration of the Extended Warranty Period, Voss shall coordinate with the manufacturer to provide replacement product for Customer installation. Voss is available to provide the installation services for the Customer at an additional cost.
4. During the twelve (12) month Initial Warranty Period, specifically for products furnished under this Agreement that are installed over twenty (20) feet above finished floor:
 - a. During the (12) month Initial Warranty Period, Voss will provide warranty related labor only one time at or near the end of the initial warranty period.
 - b. All costs for lift rental and/or specialty access equipment are excluded from warranty coverage and shall be the responsibility of the Customer to provide or make payment to Voss for these cost(s).
5. Halogen and/or other legacy products: These products, if installed as part of this Agreement and found to be defective beyond the twelve (12) Initial Warranty Period, may be covered by a manufacturer's warranty.
 - a. Initial Warranty Period: If a manufacturer warranty is offered and products are available, Voss will obtain replacement product(s) and provide installation.
 - b. Extended Warranty Period: If product(s) are no longer available or if warranty coverage is not offered, replacement for defective products will not be available. All costs for lift rental and/or specialty access equipment are excluded from warranty coverage and shall be the responsibility of the Customer to provide or make payment to Voss for these cost(s).
6. In the event that Voss provides services as outlined within this Warranty section and it is found that items furnished and installed under this Agreement are functioning normally, Customer shall be required to reimburse Voss for any and all costs related to the services provided.

Voss shall not provide warranty coverage if any of the following occurs:

 - a. The Customer is in default of the project Agreement, including non-payment, and/or;
 - b. If the defect results from normal operational wear, and/or;
 - c. Damages result any entity other than Voss involved with testing, repair of any portion of the lighting fixtures or lighting branch circuit, including any work involving the branch circuit and/or overcurrent protection that furnishes power to items that are not functional and are furnished and installed by Voss under this the project agreement.

TECL 30854: Regulated by the Texas Department of Licensing and Regulation. PO Box 12157, Austin, Texas 78711.

(800) 803-9202, (512) 463-6599. Website: www.tdlr.texas.gov

OK 00164441

ROC C-11 322569

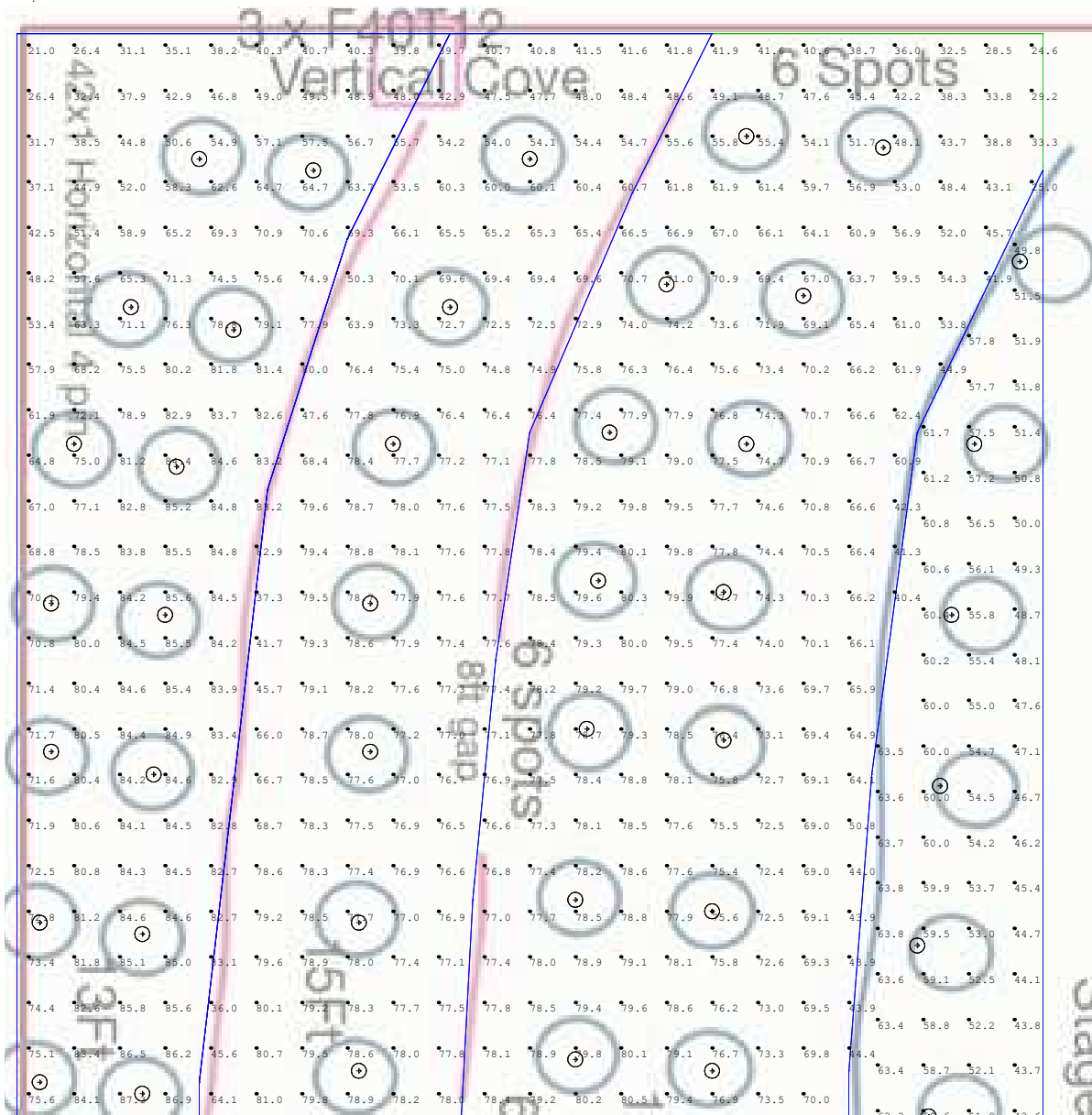
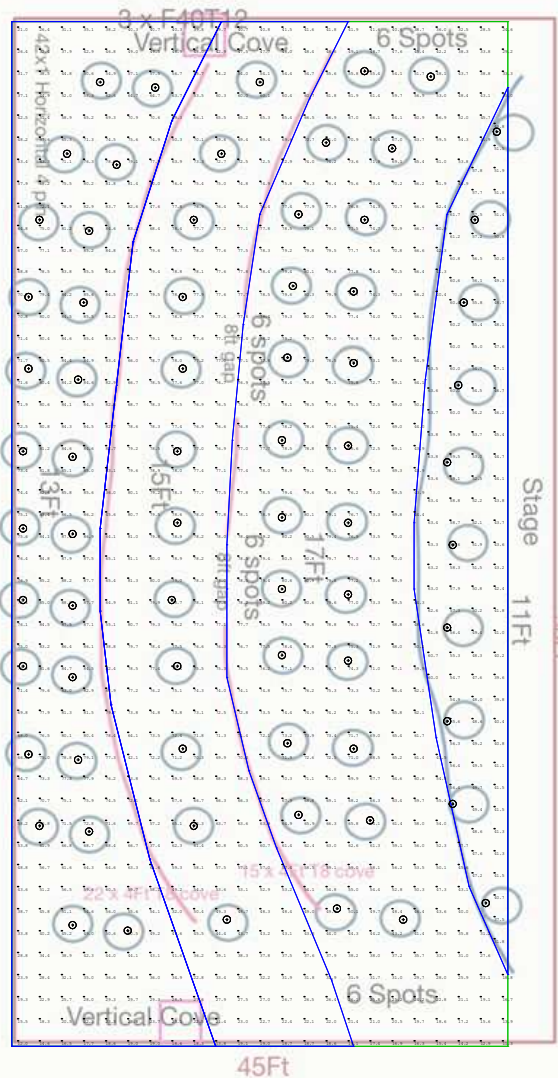

Gering School

Auditorium lighting study

Disclaimer:

This photometric study, as an instrument of service, is provided by, and is the property of Voss Lighting. All dimensions and luminaire locations represent recommended positions based upon project specifications provided to Voss Lighting. The project engineer and/or architect must determine applicability of the layout to existing field conditions. The calculations contained herein represent illumination levels taken from a laboratory setting under controlled conditions, in accordance with the IESNA approved methods. Actual or measured values may differ from forecasted results due to variations in electrical voltage, tolerance levels, obstructions, other light sources, and other variables that were not considered when this report was generated. It is the sole responsibility of the architect, owner, or owner's representative to ensure compliance with any applicable design standards and codes in effect.

Drawn By:

B Whiting

Date:

1/8/2026

Scale



Luminaire Schedule								
Symbol	Qty	Label	Arrangement	Lum. Lumens	LLF	Description	Lum. Watts	Total Watts
⊙	70	NU8-45-75	Single	3691	1.000	8in RETROFIT DOWNLIGHT	40	2800

Calculation Summary							
Label	CalcType	Units	Avg	Max	Min	Avg/Min	Max/Min
Room_1_Workplane	Illuminance	Fc	62.36	80.9	11.3	5.52	7.16
Stage_Top	Illuminance	Fc	52.47	63.8	31.8	1.65	2.01
Step_1_Top	Illuminance	Fc	63.29	88.2	12.0	5.27	7.35
Step_Top	Illuminance	Fc	63.40	81.3	13.8	4.59	5.89

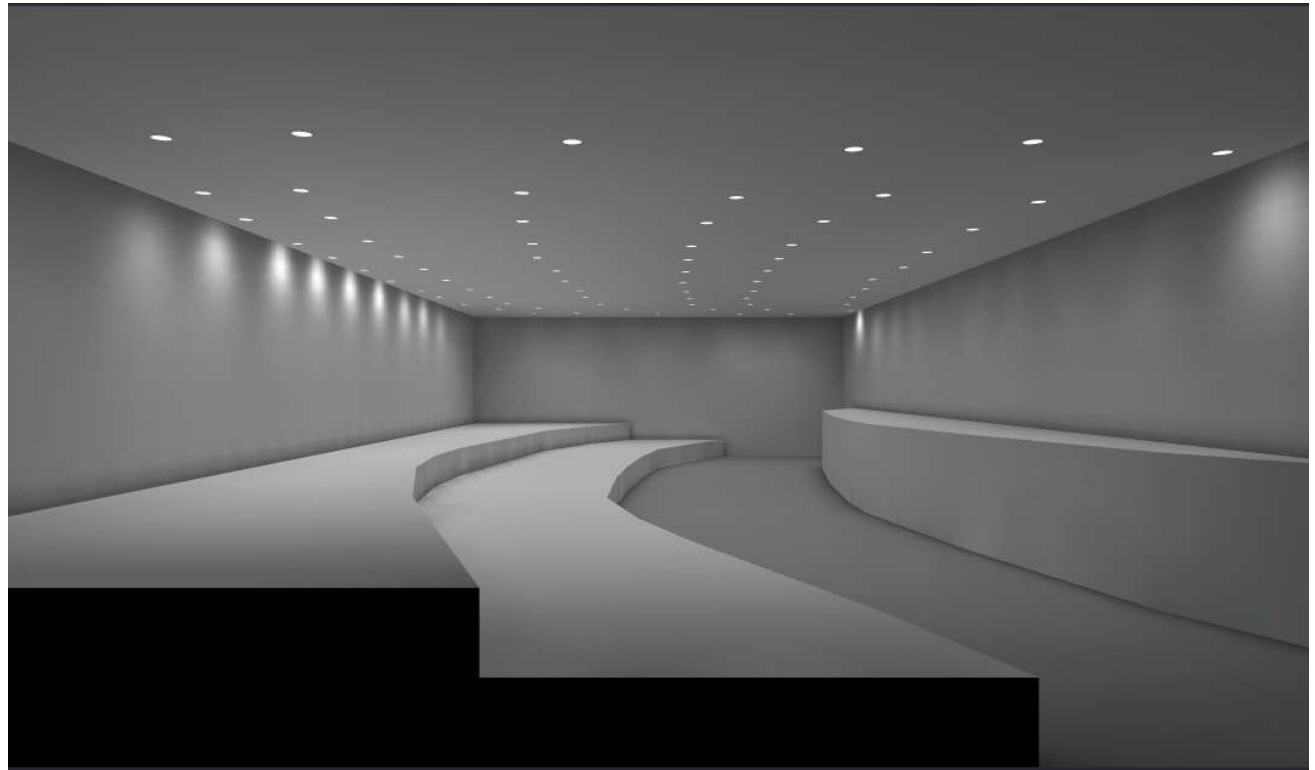

All values shown are horizontal footcandels (Fc) at 30" A.F.F.
 Values do not represent obstruction from equipment, or other objects.
 Values do not represent contribution from daylight penetration, or other light sources.

Existing System Disclaimer:
 The calculations contained herein represent illumination levels taken from a laboratory setting under controlled conditions, in accordance with the IESNA approved methods. Actual or measured values may differ due to conditions such as, but not limited to, system age and efficacy, non-functioning, or improperly functioning system components, and/or environmental/atmospheric conditions not considered when this report was generated. Existing system brand, and/or model numbers, including luminaire, ballasts and lamps may not be represented here. Results are typical, but not guaranteed.

Gering School

Auditorium lighting study

Disclaimer:
 This photometric study, as an instrument of service, is provided by, and is the property of Voss Lighting. All dimensions and luminaire locations represent recommended positions based upon project specifications provided to Voss Lighting. The project engineer and/or architect must determine applicability of the layout to existing field conditions. The calculations contained herein represent illumination levels taken from a laboratory setting under controlled conditions, in accordance with the IESNA approved methods. Actual or measured values may differ from forecasted results due to variations in electrical voltage, tolerance levels, obstructions, other light sources, and other variables that were not considered when this report was generated. It is the sole responsibility of the architect, owner, or owner's representative to ensure compliance with any applicable design standards and codes in effect.

Drawn By:

B Whiting

Date:

1/8/2026

Scale



PROJECT INFORMATION		
JOB NAME		TYPE
ORDERING CODE		

NU8

8" Round Downlight Standard White

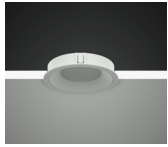
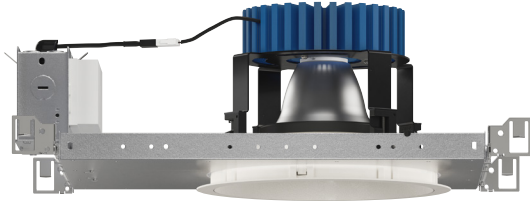

Trim

12° - 75° BEAM (Note: Specifications are subject to change without notice)		
14mm COB PERFORMANCE DATA		
LED LIGHT ENGINE	NOMINAL DELIVERED LUMENS	SYSTEM WATTAGE
10LM	1010LM @30K/80CRI	9W
15LM	1510LM @30K/80CRI	12W
20LM	1990LM @30K/80CRI	16W
25LM	2470LM @30K/80CRI	20W
30LM	2940LM @30K/80CRI	24W
35LM	3500LM @30K/80CRI	29W
40LM	4050LM @30K/80CRI	35W
45LM	4480LM @30K/80CRI	40W
10LM	860LM @30K/90CRI	9W
15LM	1280LM @30K/90CRI	12W
20LM	1690LM @30K/90CRI	16W
25LM	2100LM @30K/90CRI	20W
30LM	2490LM @30K/90CRI	24W
35LM	2970LM @30K/90CRI	29W
40LM	3440LM @30K/90CRI	35W
45LM	3810LM @30K/90CRI	40W
Notes	Delivered lumens based on 60D optic with no lens, (see page 2)	

FEATURES

- Thermally optimized for longevity
- 2" bezel regress with 1/16" micro flange
- 12° to 75° optical beam control
- UGR < 20
- Glare control, specialty optics, trim options, and custom finishes available
- Microban® antimicrobial finish available on all exposed painted surfaces

LED

- 90 CRI: SDCM = 2-step MacAdam Ellipse, Lumen Maintenance: L₇₀ > 66,000 hrs
- 80 CRI: SDCM = 2-step MacAdam Ellipse, Lumen Maintenance: L₇₀ > 66,000 hrs

DIMMING AND CONTROLS

- elDoLED flicker free 0-10V dimming to 0% and 1%
- elDoLED flicker free DALI dimming to 0% and 1%
- DMX dim to zero
- Lutron Hi-lume (Eco System) dimming to 0.1% and 1%
- Lutron Hi-lume 1% 3-wire/Ecosystem
- Leading & trailing edge (Triac/ELV) dimming to 1%
- Casambi dimming to 1%
- NLight control interface dimming to 0%

LISTING

- ULus Listed to UL1598 & UL2108; cUL Listed to CSA C22.2 #250.0
- IP65 with lens - Suitable for wet locations with lens - Suitable for damp locations without lens
- Non-conductive, dead-front construction (shower approved)
- NSF/ANSI-2 with lens (Non-Food and Splash Zones)
- 5 Year Limited warranty

CONSTRUCTION

- Lexan™ (PC) highly resistant to impact and heat (240°F)
- Optimal material for wireless signal connectivity
- Shatter proof acrylic bezel lens
- Electrocoated 16-gauge cold-rolled steel construction
- Accommodates ceiling thickness from 1/8" to 1-5/8"

ELECTRICAL

- 120V-277V, 120 only Triac / ELV
- Power factor ≥ 0.9
- 2kV driver input surge protection
- Remote and Integral (ITS) emergency test switch
- 7W, 10W (T20 CEC) and 12W EM 90min battery
- Max. ambient installation temperature 95°F (35°C)
- Low Voltage Luminaire option, see page 8.

FIXTURE HEIGHT

10LM-30LM LOW LUMEN

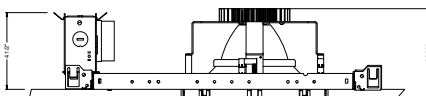

40LM-45LM HIGH LUMEN

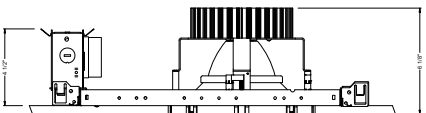

TRIMMED (STANDARD)

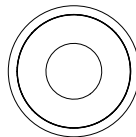

ceiling cutout
8-1/2" diameter
ceiling thickness
1/8" to 2"

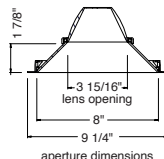

alphabet

PROJECT INFORMATION		
JOB NAME		TYPE
ORDERING CODE		

ORDERING CODE																											
SERIES	NU8	NU8																									
TYPE	RD	round downlight																									
LED	SW	standard white																									
DELIVERED LUMENS	10LM	1010 lm																									
	15LM	1510 lm																									
	20LM	1990 lm																									
	25LM	2470 lm																									
	30LM	2940 lm																									
	35LM	3500 lm																									
	40LM	4050 lm																									
	45LM	4480 lm																									
Standard Configuration: 3000K 80CRI 60D Calculated Delivered Lumens = [Delivered Lumen Value] x [CCT Multiplier] x [Reflector Multiplier]																											
CCT	27K	2700K																									
	30K	3000K																									
	35K	3500K																									
	40K	4000K																									
		<table border="1"> <thead> <tr> <th>CCT</th> <th>2700K</th> <th>3000K</th> <th>3500K</th> <th>4000K</th> </tr> </thead> <tbody> <tr> <td>CRI</td> <td>80+</td> <td>90+</td> <td>80+</td> <td>90+</td> </tr> <tr> <td>CCT MULTIPLIER FOR LUMEN OUTPUT</td> <td>0.96</td> <td>0.81</td> <td>1</td> <td>0.85</td> </tr> <tr> <td></td> <td></td> <td></td> <td>1.03</td> <td>0.88</td> </tr> <tr> <td></td> <td></td> <td></td> <td>1.06</td> <td>0.91</td> </tr> </tbody> </table>	CCT	2700K	3000K	3500K	4000K	CRI	80+	90+	80+	90+	CCT MULTIPLIER FOR LUMEN OUTPUT	0.96	0.81	1	0.85				1.03	0.88				1.06	0.91
CCT	2700K	3000K	3500K	4000K																							
CRI	80+	90+	80+	90+																							
CCT MULTIPLIER FOR LUMEN OUTPUT	0.96	0.81	1	0.85																							
			1.03	0.88																							
			1.06	0.91																							
CRI	80	80 CRI																									
	90	90 CRI																									
OPTIC & LM MULTIPLIER SEE PAGE 3	12D	12 degrees	(0.96)																								
	20D	20 degrees	(0.96)																								
	35D	35 degrees	(0.95)																								
	50D	50 degrees	(0.99)																								
	60D	60 degrees	(1.00)																								
	75D	75 degrees	(0.91)																								
ACCESSORY	HCL¹	honeycomb louver	(0.70)																								
Attached to bezel																											
BEZEL LENS SEE PAGE 3	NL²	no lens	(1.00)																								
	CL	clear lens	(0.96)																								
	E³	elliptical beam spread	(0.92)																								
	DL	diffused lens	(0.93)																								
	HET	high efficiency textured lens, similar to Solite™	(0.95)																								
	SBL	smoothing beam lens	(0.95)																								
TRIM COLOR SEE PAGE 3	BK	black																									
	WH	white																									
	MC	matte chrome																									
	BZ	bronze																									
	WT	wheat																									
	CC⁴	custom color, consult factory for details																									
Antimicrobial finish, add AM to black, white or matte chrome i.e. BKAM.																											
BEZEL COLOR SEE PAGE 3	BK	black	(0.98)																								
	WH	white	(1.00)																								
	BZ	bronze	(0.98)																								
	MC	matte chrome	(0.99)																								
	WT	wheat	(0.99)																								
	CC⁴	custom color, consult factory for details																									
Antimicrobial finish, add AM to black, white or matte chrome i.e. BKAM.																											

ORDERING CODE		
MOUNTING OPTIONS SEE PAGE 6, 7	NC	new construction with ceiling fitting plate
	RET	retrofit, no ceiling fitting plate
VOLTAGE	120	120V
	UNV	120V-277V
	LVL⁵	low voltage luminaire
DIMMING	DIM10	eldoLED flicker free 0-10V dimming to 1%
	DIM10Z	eldoLED flicker free 0-10V dimming to 0%
	DALI	eldoLED flicker free DALI-2 dimming to 1%
	DALIZ	eldoLED flicker free DALI-2 dimming to 0%
	LUTP⁶	Lutron Hi-lume Premier Ecosystem dimming to 0.1%, Soft-on & Fade-to-Black
	ELV1⁷	leading & trailing edge (Triac/ELV) dimming to 1%
	NLT	nLight control interface: standard Cat-5/RJ45 connection (female), dim to off
	CAS	Casambi control with flicker free 1% dimming
	LUT	Lutron Hi-lume Ecosystem dimming to 1%, Soft-on & Fade-to-Black
	DMX-RJ45	DMX control dimming to 0.1% with RJ45 connection
	DMX-XLR	DMX control dimming to 0.1% with XLR 5pin connection
	DMX-WL	DMX control dimming to 0.1% with wire lead connection
L3DA	Lutron Hi-lume 1% 3-wire/Ecosystem	
ND	No Driver Included. Customer to Supply PoE system components or order remote driver separately. Refer to POE/Remote Driver reference sheet for additional details.	
ELECTRICAL OPTIONS	EM7⁷	emergency battery backup, 90 minutes at 7W to LED
	EM12⁷	emergency battery backup, 90 minutes at 12W to LED
	EM10CA20⁷	remote emergency battery backup, 90 minutes at 10W to LED, CA title 20

ADDITIONAL MOUNTING INFO	
New Construction Bar Hangers (included)	Mounting Length: 14-3/4" to 26"
Extension Kit p/n: K20266 (ordered separately, 1 per fixture)	Extends a pair of Bar Hangers Total Mounting Length: 29" to 48"

YOUR COMPLETED ORDERING CODE
Follow the steps to specify your fixture, example:
NU8 - RD - SW - 30LM - 35K - 90 - 20D - SBL - WH - WH - NC - 120 - DIM10 - EM7

NOTES

- HCL not available with lens.
- NL option does not meet requirement for AT/DF/WET/NSF listings.
- Actual beam distributions for optic (Actual beam distributions for optic (12D= 34° x 63°, 20D= 40° x 68°, 35D= 48° x 75°, 50D= 58° x 85°, 60D= 66° x 92°, 75D= 85° x 100°).
- Custom set up fee plus minimum quantity required per color.
- Must select ND dimming code, for remote driver or POE specifications see page 9.
- LUTP not available in 25LM/30LM/40LM/45LM.
- ELV (120V) not available in 10LM
- For integrated test switch add "ITS" after emergency backup code, i.e. EM12ITS. Test switch is mounted in the bezel of the fixture.

* EdoLED and DMX uses logarithmic dimming curve as standard. For linear dimming curve, add "LIN" after dimming code, i.e. DIM10LIN.

Specflex | **AFSD58 Dry Location Series**
Architectural Strip Lighting | RGBW, 58 LEDs per foot

24V Architectural Flex Strip, RGBW, 58 LEDs per foot

This series offers a dynamic color output using individual RGB (Red, Green, and Blue) diodes in each LED plus one (1) White LED in 2700K or 3000K. Designed for reliable performance and ease of use. Ideal for cove, slot, undercabinet, millwork details, architectural reveals, and endless accent lighting applications.



FEATURES

- Medium Density: 58 LEDs per foot
- One (1) Wattage/Lumen option
- 95+ CRI and <2 SDCM (White LED) ensures excellent color rendering and consistency
- Full Reels or Factory Cut into Custom Lengths
- Low power consumption with consistent, stable performance
- Wide range of Non-dimming LED Drivers, Controllers, Mounting Channels, and Lenses
- Declare Listed
- Complete System is ccCSAus Listed to UL and CSA Standards



SERIES	AFSD58-7RGBW			
WATTAGE	7W/Ft			
LUMEN OUTPUT ¹	374Lm/Ft			
EFFICACY ¹	53Lm/W			
COLOR	White	Red	Green	Blue
WAVELENGTH	N/A	620-625nm	525-535nm	465-470nm
LUMEN OUTPUT PER COLOR	176Lm/Ft	32Lm/Ft	135Lm/Ft	35Lm/Ft
MAX RUN LENGTH	16.4Ft			
LED DENSITY	58 LEDs/Ft			
CUT INCREMENT	2.46-Inches (62.5mm), Field Cuttable			
STRIP LIGHT WIDTH	0.47-Inches (12mm)			
MOUNTING	3M™ 300LSE Double Sided Tape / Channels & Clips			
COLOR TEMPERATURE	RGB+2700K, RGB+3000K			
CRI	95+, R9>84 (White LED)			
COLOR CONSISTENCY	<2 SDCM (White LED)			
OPERATING VOLTAGE	24V DC			
OPERATING TEMP.	-25° to 40°C (-13° to 104°F)			
LIFE RATING	50,000 Hours @ 70% Lumen Maintenance			
LISTINGS	ccSAus Listed to UL Standards and CSA Standards Suitable for Dry Locations, IP20 Rated. For Wet Location rated options, see AFSD58 Wet Location Series Declare Listed RoHS Compliant For use with Class 2 LED Drivers only			
WARRANTY	Five (5) year replacement after date of purchase when installed within Mounting Channel Three (3) year replacement after date of purchase when installed without Mounting Channel			

1. Approximate lumen output based on 3000K with all channels full on; see photometric test results for additional information

Specflex | **AFSD58 Dry Location Series**
Architectural Strip Lighting | RGBW, 58 LEDs per foot

ORDERING INFORMATION

FULL REELS

- Full Reels are available in Max Run Length for each available Wattage
- Each Reel has a 72-inch Plenum Rated Cable Power Lead soldered to the start of the length
- Additional Plenum Rated Cable available (ordered separately), see Page 7 for details
- Reels can be cut in the field to desired length at the indicated cut points; excess Strip Light can be configured for additional installations

Example Order: AFSD58-7RGBW30K-R

Series	CCT¹/CRI	Illuminated Length
AFSD58-7RGBW RGBW Dynamic Color: 58LEDs/Ft, 7W/Ft	95+ CRI 27K RGB + 2700K 30K RGB + 3000K	R Full Reel with 72-inch Power lead 7W/Ft: 16.4Ft Reel

CUSTOM LENGTHS

- Custom Lengths cannot exceed the Maximum Run Length for the specified Wattage; see Max Run Length table on Page 12 for details
- Allow additional lead time for Custom Lengths
- Custom Lengths are made-to-order and are not returnable; approved Submittal Sheets are required before processing the order

Example Order: AFSD58-7RGBW30K-S-NT-C188

Series	CCT¹/CRI	Length in Inches	Length in Inches	C
AFSD58-7RGBW RGBW Dynamic Color: 58LEDs/Ft, 7W/Ft	95+ CRI 27K RGB + 2700K 30K RGB + 3000K	Start Termination	End Termination	Custom Length
		S² 72-inch Soldered Lead Wires SXXX² Custom Length Lead Wires	NT No Termination S² 72-inch Soldered Lead Wires SXXX² Custom Length Lead Wires	CXXX Custom Length Desired length is specified in inches i.e. if the desired length is 15 Ft.-8- Inches or 188-inches total, enter C188 AFSD58 Series has a cut increment of 2.46-inches, illuminated length will be rounded down to nearest cut increment

1. Consult factory for additional CCT options; additional lead time for special request CCTs
2. All Lead Wires come sheathed in a Plenum Rated Cable rated to 90°C minimum; specify Custom Length Lead Wires in inches; max length: 120-inches

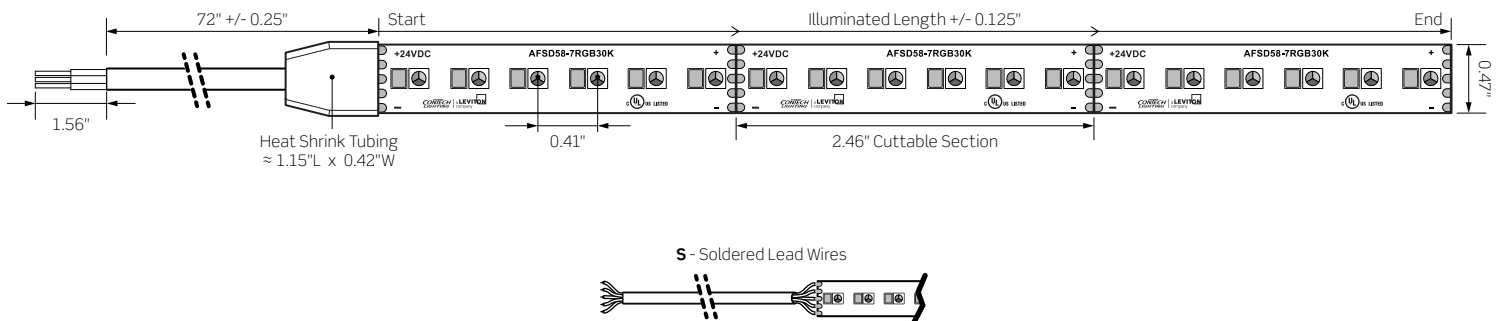

Specflex | **AFSD58 Dry Location Series**
 Architectural Strip Lighting | RGBW, 58 LEDs per foot

24V MOUNTING CHANNELS AND ACCESSORIES

ALUMINUM MOUNTING CHANNEL

- Provides excellent heat sinking and protection to the LEDs while ensuring a clean, straight run
- Anodized Satin Aluminum Channel
- All Channels and Accessories are Declare Listed

CHANNEL MOUNTING CLIPS

- Stainless Steel
- 2-Inches between clips recommended for most applications

CHANNEL ENDCAPS

- Creates a clean finish to the Mounting Channel
- ABS Grey Plastic
- Endcaps are ordered individually; one (1) solid Endcap and one (1) open Endcap (with Slot) is recommended
- Use Endcaps with Slots for Power Feed

Channel, Lens, Endcaps, and Mounting Clips are ordered separately

SHALLOW SURFACE MOUNTING CHANNEL

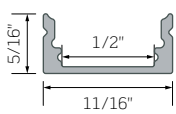

Shallow Surface Mounting Channel



Frosted Diffusion Lens (Shown in Channel)

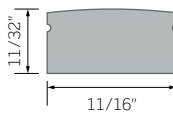

Shallow Surface Channel Endcap

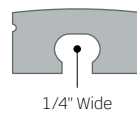

Shallow Surface Channel Endcap with Slot

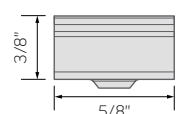
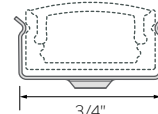

Shallow Surface Channel Mounting Clips

Channel and Lens

AFEX1209S72-S
6 Ft. Shallow Surface Mounting Channel, Aluminum

AFL1272-FR
6 Ft. Shallow Surface Channel Diffusion Lens, Frosted; Slight Pixelation with Diffusion Lens

Endcaps

AFEX1209S-EC
Shallow Surface Channel Solid Endcap, Grey

AFEX1209S-ECS
Shallow Surface Channel Endcap with Slot, Grey

Mounting Clips

AFEX125-MC4
Four (4) Mounting Clips, Stainless Steel

DEEP SURFACE MOUNTING CHANNEL

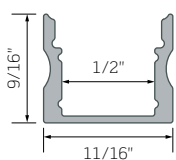

Deep Surface Mounting Channel

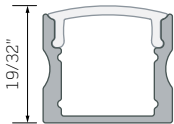

Frosted Diffusion Lens (Shown in Channel)

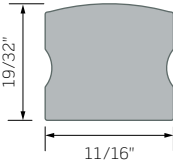

Deep Surface Channel Endcap

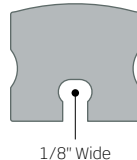

Deep Surface Channel Endcap with Slot

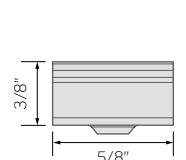
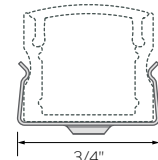

Deep Surface Channel Mounting Clips

Channel and Lens

AFEX1215S72-S
6 Ft. Deep Surface Mounting Channel, Aluminum

AFL1272-FR
6 Ft. Deep Surface Channel Diffusion Lens, Frosted; No Pixelation with Diffusion Lens

Endcaps

AFEX1215S-EC
Deep Surface Channel Solid Endcap, Grey

AFEX1215S-ECS
Deep Surface Channel Endcap with Slot, Grey

Mounting Clips

AFEX125-MC4
Four (4) Mounting Clips, Stainless Steel

Specflex
Architectural Strip Lighting

AFSD58 Dry Location Series
RGBW, 58 LEDs per foot

24V ACCESSORIES

Plenum Rated Cable

Five Conductor Plenum Rated Cable

Model Number			
CMP-5C-10	10Ft	CMP-5C-30	30Ft
CMP-5C-15	15Ft	CMP-5C-50	50Ft
CMP-5C-20	20Ft	CMP-5C-100	100Ft



24V CONTROLLERS

TLPRTW

4-Channel Power Repeater

- Enables synchronized control of multiple runs from one controller
- Not UL Listed for outdoor use
- Use with Non-dimming LED Drivers

Model Number	
TLPRTW	4-Channel Power Repeater (5-5/16" L x 1-3/4" W x 1-1/8" D)



TLPRGBWRF

RGB/RGBW 28-Key Remote Controller

- 8-Key RF Remote for color, speed, and brightness control
- Seven (7) programmable scenes
- 20AMP Max
- Use with Non-dimming LED Drivers

Model Number	
TLPRGBWRF	4-Channel Power Repeater (6-7/8" L x 1-3/4" W x 1-3/16" D)



TLPINT

DMX 512 CV Decoder

- Designed to convert universal DMX 512 signal to PWM signal when used with a DMX 512 console (by others)
- Use with Non-dimming LED Drivers
- Not UL Listed for outdoor use

Model Number	
TLPINT	DMX 512 CV Decoder (6-3/16" L x 3-1/8" W x 1-5/8" D)



TLPRGBWTC

RGB/RGBW Touch Controller

- Dial Touch Controller, select color by using color wheel
- Speed and brightness control
- Pre-selected modes
- 20AMP Max
- Use with Non-dimming LED Drivers

Model Number	
TLPRGBWTC	RGB/RGBW Touch Controller (6-7/8" L x 1-3/4" W x 1-3/16" D)



Specflex | **AFSD58 Dry Location Series**
Architectural Strip Lighting | RGBW, 58 LEDs per foot

PHOTOMETRICS

AFSD58-7RGBW30K ALL ON: 24V Dry Location SpecFlex RGBW Strip Light

7W/Ft, 58LEDs/Ft, 1-Foot Strip, 95+ CRI

Fixture Delivered Lumens: 373.9
Total Watts@24V: 7.0
Lumens Per Watt: 53.4
Center Beam Candle Power: 119
Beam Distribution: 122°
Spacing Criterion: 1.31

LM-63 Test No. G22042801
LM-79 Test No. S22042701

Intensity Distribution

DISTANCE (FT.)	FOOTCANDLES (FC)	BEAM DIA. (FT.)
2 FT	29.9	7.3
4 FT	7.5	14.5
6 FT	3.3	21.8
8 FT	1.9	29.0
10 FT	1.2	36.3
12 FT	0.8	43.5

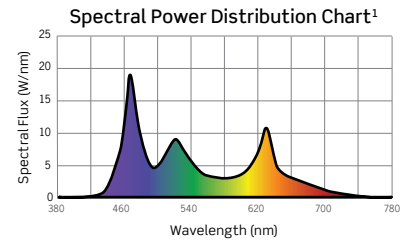
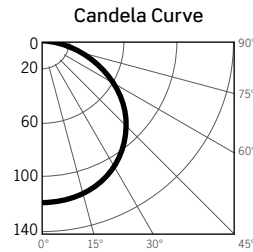

1. Colors Present within the Light Source

CCT MULTIPLIERS

2700K	3000K
0.98	N/A

AFSD58-7RGBW30K ALL ON TM-30 DATA

ANSI/IES TM-30-18 Color Rendition Report Test No. S22042701

Colors are for visual orientation purposes only

R _f	71
R _g	97
CCT (K)	7785K
D _{uv}	0.0063
u'	0.1896
v'	0.4589

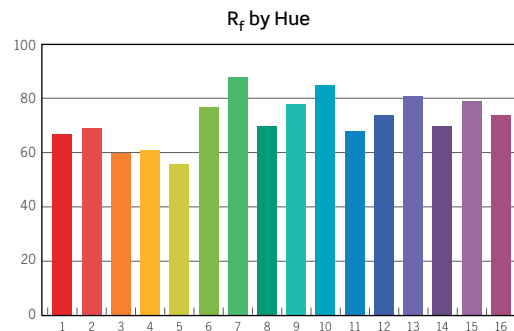
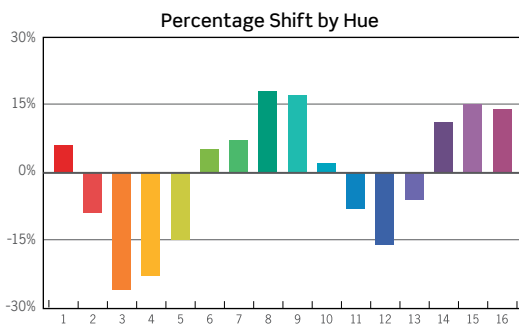
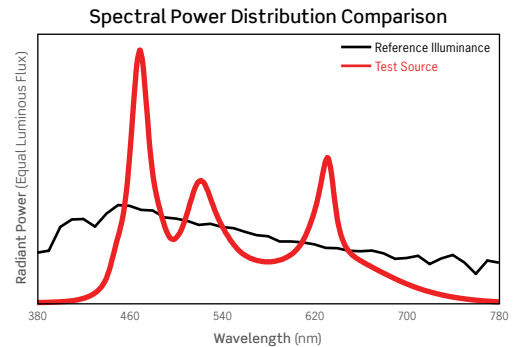
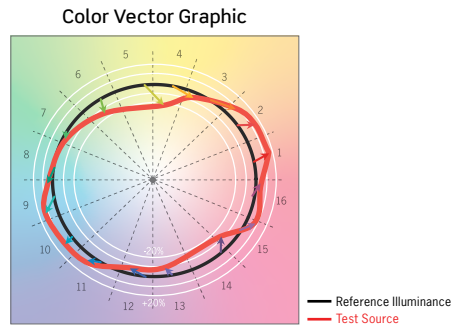

HUE BIN	1	2	3	4	5	6	7	8	9	10	11	12	13	14	15	16
HUE SHIFT	6%	-9%	-26%	-23%	-15%	5%	7%	18%	17%	2%	-8%	-16%	-6%	11%	15%	14%
R _f VALUE	67	69	60	61	56	77	88	70	78	82	68	74	81	70	79	74

RGBA LED Retrofit

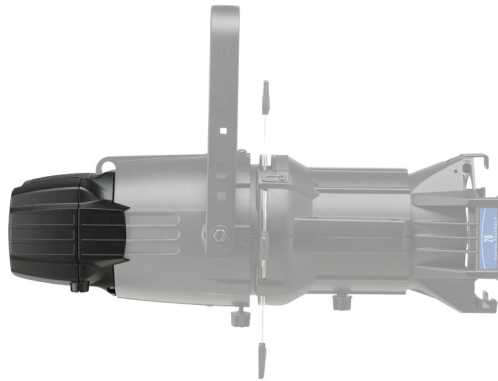

Type(s)

Project

Date

Notes

GENERAL INFORMATION

Source 4WRD Color II is a leap forward in performance that transforms your existing Source Four incandescent profile into an RGBA LED fixture, unlocking the world of additive color mixing, saturated washes, and quick color changes. You get more stage looks with fewer fixtures while using less energy. No more changing lamps or replacing burned out gel. The simple nondestructive upgrade takes less than five minutes. Source 4WRD Color II uses switched power, 100–240 VAC, and dims via DMX.

APPLICATIONS

- Energy-saving retrofits
- Houses of worship
- Universities and schools
- Hospitality
- Retail
- Exhibition centers
- Meeting rooms
- Clubs
- Theatres

PRODUCT FEATURES

- New, patented LED array and color mixing system
- Increased brightness
- 2x output in red
- Improved color gamut and uniformity
- Industry leading warranty and support

ORDERING INFORMATION

Source 4WRD Color II

MODEL	DESCRIPTION	UL PART NUMBER	CE PART NUMBER	
S4WRDCII	Source 4WRD Color II Retrofit Kit, Black	7068A1011	7068A1211	

For white please add -1 to the model / part number.

Ordering information continued on page 5.



PRODUCT SPECIFICATIONS

Source

LED details	Nichia LEDs
Max lumens (26 EDLT) (Full On / 3200 K / 5600 K)	6,042 / 5,051 / 5,687
Lumens per watt (Full On / 3200 K / 5600 K)	42.2 / 46.3 / 45.9
L70 rating (hours to 70% output)	>60,000 hours*

*L70 value based on manufacturer's anticipated results

Color

Colors used	RGBA (Red, Green, Blue, and Amber)
Color temperature range	2200–6500 K
Calibrated array	Yes
Red shift	No

Optical

Field angle range	Swappable lens tubes between 5–90 degrees
Gate size	79 mm
Aperture size	Lens dependent
Pattern projection	Yes
Pattern size	A or B (see manual)
Camera flicker control/ Hz range	Yes, 1.2 kHz and 20 kHz

Control

Input method	DMX Control
Protocols	DMX / RDM via RJ45
Modes (Footprint)	1 (1- Intensity, 2- Red, 3- Green, 4- Blue, 5- Amber, 6- Strobe)
RDM configuration	Yes
UI type	7-segment address display
Local control	Yes
Onboard presets	Yes, 12
Onboard sequences	Yes, 5
Onboard effects	No
FixtureLink support	Yes

Electrical

Voltage range	100–240 V (50–60 Hz) (not dimmable)
Input method	Hardwired, 1 m cord, bare end or various connector options (120 V) Hardwired, 1 m cord, bare end (240 V)
Inrush	32 A (first half-cycle) at 120 V 60 A (first half-cycle) at 240 V
Fixtures per circuit*	120 V: 10 (20 A switched circuit, R20 module or similar) 240 V: 10 fixtures per non-dimmed circuit (ER15AFR module)
Wattage (Typical/ Standby)	146 W / 3.0 W (120 V) 143 W / 2.9 W (240 V)
Current draw	1.25 A at 120 V 0.67 A at 240 V

*All measurements are for 120 V, 60 Hz. Results may vary in different regions.

Thermal

Ambient operating temp	5°C to 40°C (41°F to 104°F)
Fan (controllable)	Yes (no)
Droop compensation	No
dB range	27 dBA (average at 1 m)
BTUs/hour	458 (120 V) 449 (240 V)

Physical

Materials	Cast aluminum
Color options	Black, white, or custom color
Mounting options	Yoke
IP rating	IP20, indoor only
Weight	3.6 lb (1.63 kg) (Retrofit only)
Included accessories	Source 4WRD mounting post and reflector

Warranty

Warranty details	etcconnect.com/warranty
------------------	--

Regulatory and Compliance

Approved regulatory standards	UL 1573 (complete luminaire) UL 1598C (retrofit kit) CSA C22.2 No. 166 (complete luminaire) CSA TIL B79-A (retrofit kit) CE Compliant UKCA Compliant
-------------------------------	---

PRODUCT FEATURES



EASY LED RETROFIT

Designed to turn any full size Source Four incandescent fixture into an LED fixture in seconds.



LEND COLOR TO ANY SPACE

Millions of colors with the same fixtures you've relied on for years.

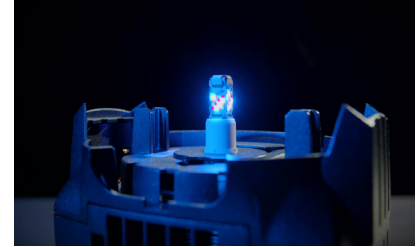

DMX AND LOCAL CONTROL

DMX In and Thru, with 12 built-in color presets and 5 built-in sequences for stand-alone operation.

COLOR METRIC INFORMATION

SOURCE 4WRD COLOR II 3200 K TM-30-18

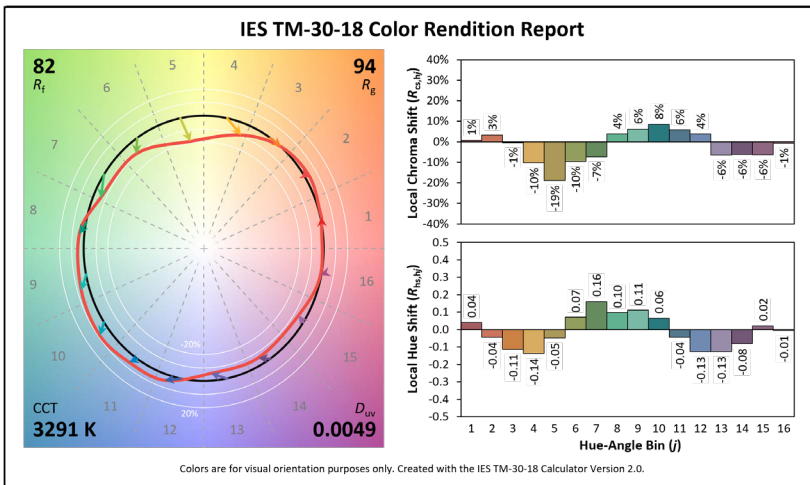

SOURCE 4WRD COLOR II 5600 K TM-30-18

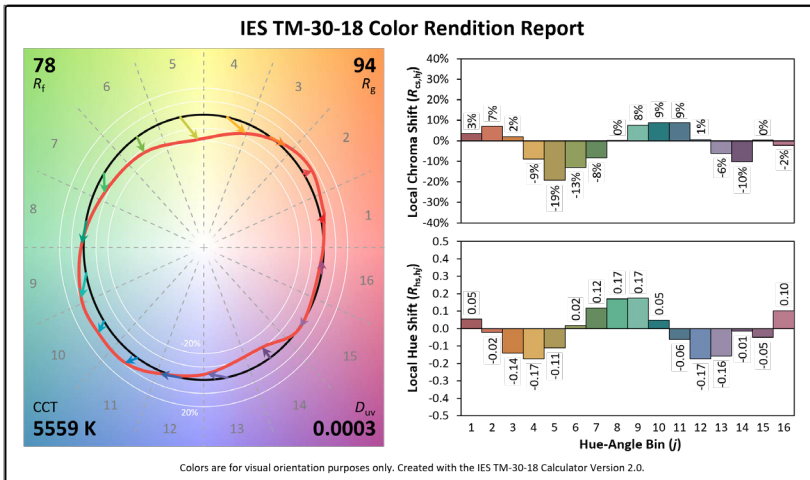

COLOR METRIC INFORMATION

Additional Color Metrics

	3200 K	5600 K
CRI R _a (R ₉)	88 (96)	80 (63)
TLCI	78	83

PHOTOMETRY INFORMATION

For full Source 4WRD Color II photometry data, use the MyETC: Photometrics app. Visit etconnect.com/fixtureapps for more information.

DEGREE	S4WRD COLOR II FULL-ON	S4WRD COLOR II 3200 K	S4WRD COLOR II 5600 K
5	3,303	2,759	3,103
10	4,071	3,401	3,824
14	4,230	3,533	3,973
19	3,619	3,023	3,399
19 EDLT	4,396	3,672	4,129
26	4,505	3,763	4,232
26 EDLT	6,042	5,051	5,687
36	5,736	4,791	5,388
36 EDLT	5,814	4,857	5,461
50	5,265	4,398	4,945
50 EDLT	5,984	4,999	5,621
70	6,364	5,316	5,978
90	6,354	5,308	5,968
15–30 Zoom (N/M/W)	4,632/4,947/4,407	3,869/4,132/3,681	4,351/4,647/4,140
25–50 Zoom (N/M/W)	6,394/6,358/5,981	5,341/5,311/4,996	6,006/5,972/5,618

ORDERING INFORMATION

Continued from front page...

Source Four Accessories

MODEL	DESCRIPTION	CE PART NUMBERS
400PH-A	Pattern holder (A size)	7060A1013
400PH-B	Pattern holder (B size)	7060A1014
400PH-G	Glass pattern holder	7060A1019
400SC	Safety cable	7060A1022
400RS	Drop-in iris	7060A1012
400CF	Media/gel frame (6.25 in / 159 mm)	7060A3043
400DN	Donut (6.25 in / 159 mm)	7060A1015
400TH	Top hat (6.25 in / 159 mm)	PSF1021
400HH	Half hat (6.25 in / 159 mm)	PSF10216
407CF	Media/gel frame (7.5 in / 190 mm)	7061A3007
400FBNB	Source Four fixture body without burner assembly	7060A1098
S4WRDACCKIT	Data Accessory Kit, Includes W6538, W6539 & N4086	7067K1001
W6538	RJ45 to Female 5-pin XLR adapter	W6538
W6539	RJ45 to Male 5-pin XLR adapter	W6539
N4086	RJ45 DMX Terminator	N4086
S4WRDRJ45XLR	Source 4WRD RJ45 to XLR Adapter	7067A1118

Note: For accessory colors other than black or white, please contact ETC.

Lens Tubes

MODEL	DESCRIPTION	CE PART NUMBERS
490LT	90° Lens tube with lens installed, Black	7060A2052-K
470LT	70° Lens tube with lens installed, Black	7060A2051-K
450LT	50° Lens tube with lens installed, Black	7060A2205-K
436LT	36° Lens tube with lens installed, Black	7060A2204-K
426LT	26° Lens tube with lens installed, Black	7060A2203-K
419LT	19° Lens tube with lens installed, Black	7060A2202-K
414LT	14° Lens tube with lens installed, Black	7060A2050-K
410LT	10° Lens tube with lens installed, Black	7060A2001-K
405LT	5° Lens tube with lens installed, Black	7060A2000-K
450EDLT	50° EDLT Lens tube with lens installed, Black	7060A2049
436EDLT	36° EDLT Lens tube with lens installed, Black	7060A2048
426EDLT	26° EDLT Lens tube with lens installed, Black	7060A2047
419EDLT	19° EDLT Lens tube with lens installed, Black	7060A2046

PHYSICAL

Source 4WRD Color II Dimensions (120 V and 240 V)

MODEL	HEIGHT		WIDTH		DEPTH	
	mm	in	mm	in	mm	in
Source 4WRD Color II retrofit	142	5.59	178	7.00	160	6.29
Source 4WRD Color II with fixture body and 26° lens tube	535	21.07	339	13.36	604	23.76

Source 4WRD Color II Weights* (120 V and 240 V)

MODEL	WEIGHT		SHIPPING WEIGHT	
	kg	lb	kg	lb
Source 4WRD Color II retrofit	1.69	3.73	1.93	4.25
Source 4WRD Color II with fixture body	5.99	13.20	6.35	14.00

*Source 4WRD Color II adds 0.93 kg (2.05 lb) to the total fixture weight over a standard burner assembly.

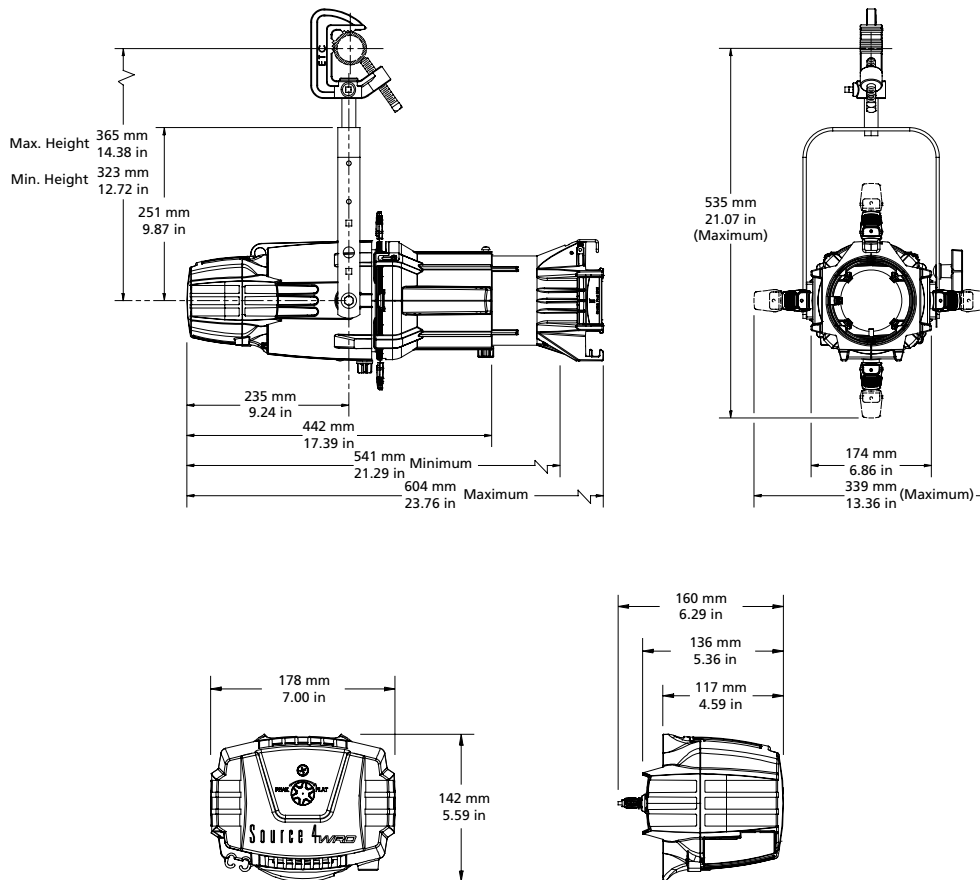

Corporate Headquarters • Middleton, WI USA
 Global Offices • London, UK • Rome, IT • Holzkirchen, DE • Paris, FR • Hong Kong
 Dubai, UAE • New York, NY • Orlando, FL • Los Angeles, CA • Austin, TX
 ©2026 ETC. All Rights Reserved. All product information and specifications subject to change. Rev E 2026-02
 *Trademark and patent info: etconnect.com/IP • Third-party license agreement info: etconnect.com/licenses

Wireless Range Extender

Overview

- Line Voltage Input 120-277 VAC
- Range Extender, Maximum Wireless Range Up To 800 ft (240 m)*
- Lightning Protection: Built-in Surge Protector At 20KV/10KA
- Operating Temp.: -30°C To 70°C, 90-95% Non-condensing
- Applicable For Indoor And Outdoor
- Casambi Wireless Mesh

Applications

The mwConnect Line Voltage Range Extender PSC-RET-100-BLE-CB provides maximum Wireless range up to 800 ft (240 m)* when used with Casambi Wireless Mesh.

PSC-RET-100-BLE-CB comes with lightning protection with a built-in surge protector at 20KV/10KA.

The device is suitable for a variety of indoor and outdoor applications. The wireless extender is rated for use in temperatures ranging from -30° to 70°C and relative humidity from 90 to 95% non-condensing.

*Note: Wireless Range is highly dependent on the integration of fixtures, surrounding environment and conditions. It is recommended to conduct testing for range accuracy.



Suitable For Interior Or Exterior Use



Physical Dimensions

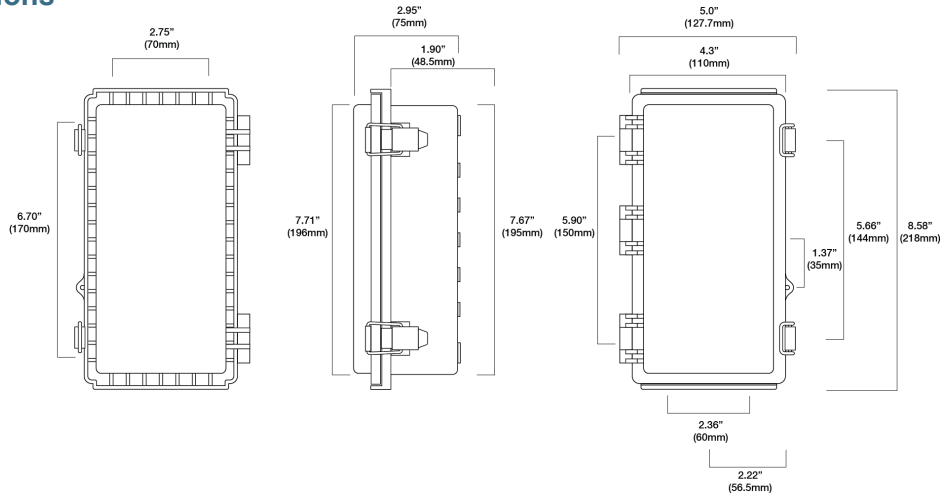

Wiring Diagram

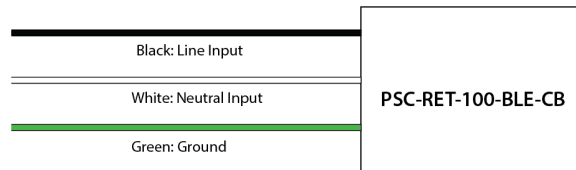

How to Order

Model No.	Description	Input Voltage
PSC-RET-100-BLE-CB	Casambii Line Voltage Wireless Mesh Range Extender	120-277 VAC

Design and specifications are subject to change without notice.

Project	
Location/Type	



Project: _____
 Reference Type: _____
 Item Code: _____
 Date: _____
 Notes: _____

CBU-ARP-LR

Bluetooth-controlled 0-10V controller with relay



PRODUCT DESCRIPTION

The CBU-ARP-LR is a Bluetooth-controlled, Casambi-enabled, long-range, one-channel 0-10V controller with built-in 2.0 A relay and a motion sensor input. It can be installed outside of a metal switch box, inside a luminaire, or into a ceiling outlet box. Simply remove a standard 1/2" knockout to install the compact module.

The CBU-ARP-LR is designed to control a single 0-10V LED driver. If the LED driver cannot be completely turned off from the 0-10V control interface, the CBU-ARP-LR has a built-in 2.0 A relay for cutting the power from the driver. It also has a 12-24 VDC input for a motion sensor. The sensor must be powered by an external power supply, such as mains voltage or auxiliary voltage from an LED driver.



WARNING
 Cancer and Reproductive Harm
www.P65Warnings.ca.gov

Warning!
 Hazardous voltages. Risk of electric shock or fire. Only qualified professionals should make the connections. Disconnect the mains power supply and verify its absence prior to installation.

The 0-10V output can also be configured as a DALI interface which allows for a much richer feature set, such as controlling a multi-channel LED driver (up to five channels) and reading diagnostic information from the driver. The CBU-ARP-LR can be controlled using the Casambi App, which can be downloaded free of charge from the Apple App Store and Google Play Store. Different Casambi-enabled products can be used from a simple one-luminaire direct control setup to a complete and full-featured lighting control system, in which up to 250 units automatically form an intelligent mesh network.

DIMENSIONS (INCH)

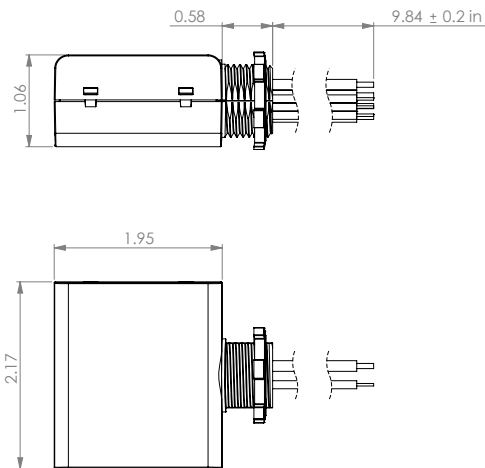

TYPE OF LOAD

Mains: rated 120-277 Vac, Max. 2.0 A, Electronic Ballast
0-10V output: 0-10 VDC, 7 mA
DALI output: 12 VDC, Max. 20 mA (sourcing)

CERTIFICATIONS

Contains FCC ID: T7V1780
 Contains IC: 216Q-1780
 UL: 5LE6 / E494741



Project: _____
 Reference Type: _____
 Item Code: _____
 Date: _____
 Notes: _____

TECHNICAL DATA

Input

- Voltage range: 120-277 VAC
- Frequency: 50-60 Hz
- Max. mains current: 40 mA
- No-load standby power: < 0,5 W

Relay Contact Rating

- Voltage range: 120-277 VAC, 50-60 Hz
- Maximum current: 2,0 A

Control Output, Class 2

- Output voltage, 0-10V: 0-10 VDC, max. 7 mA
- Output voltage, DALI: 12 VDC, max. 20 mA (sourcing)
- Max. number of connected devices: 1 driver + 1 sensor

Sensor Input, Class 2

- Sensor type: Motion (ON/OFF)
- Input voltage: 12-24 VDC
- Input current: 2-5 mA

Operating conditions

- Ambient temperature, ta: -4...+113°F (-20...+45°C)
- Max. case temperature, tc: +158°F (+70 °C)
- Storage temperature: -13...+158°F (-25...+70 °C)
- Max. relative humidity: 0...80%, non-cond.

Radio Transceiver

- Operating frequencies: 2.402...2.480 Ghz
- Maximum output power: +8 dBm

Mechanical data

- Dimensions:
 55.0 x 49.4 mm (64.2 with threaded nipple) x 27.0 mm
 2.2" x 1.9"x (2.5" with threaded nipple) x 1.1"
- Weight: 4 oz (110 g)
- Degree of protection: IP20 (indoor use only)
- Protection class: Class 2

RANGE

The range between two CBU-ARP-LR units or between a CBU-ARP-LR and a smartphone can vary a lot depending on the design of a product in which the antennas are housed and on the environment in which they operate. Long-range capabilities can reach approximately 650 feet (200 meters) with a good line of sight connection between nodes. However, if the unit is encapsulated in a metal structure, the range can be only a few feet. Therefore, thorough testing is highly recommended.

Casambi uses mesh network technology, which means that each CBU-ARP-LR also acts as a repeater. When testing the network, it is important to test that each unit can be controlled from any point in the network-covered area.

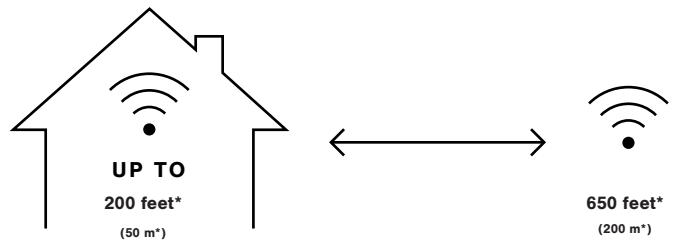

*The wireless range of a Casambi unit is dependent on several factors; how it has been integrated into a luminaire, where it has been installed; taking into consideration surrounding obstacles such as walls and other building materials that may block signals.

COMPATIBLE DEVICES



Compatible devices: Android and iOS Operating Systems.

We support the latest OS versions for Android and iOS, and their last two major versions respectively.

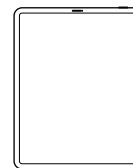

Tablets



Smartphones



Your ally in the purchasing process.

PUBLIC SECTOR | GOVERNMENT



DISCOVER A BETTER WAY TO BUY.

With our team of experts dedicated specifically to state and local government agencies, OMNIA Partners eases the procurement burden by offering the nation's most comprehensive portfolio of products and services from industry-leading suppliers. Our participants join together to leverage their purchasing volumes to achieve higher discounts from manufacturers, distributors, and other suppliers.

OMNIA Partners simplifies the purchasing process for state and local governments. Our competitively solicited cooperative purchasing contracts deliver efficiency, compliance, and value so you can get what you need without the hassle.

Utilizing the lead public agency contracting model top agencies rely upon as a best practice, OMNIA Partners brings unparalleled efficiencies and speed to the purchasing process so that government agencies can acquire the products and solutions needed for success.

The Most Valued and Trusted Resource in Procurement

OMNIA Partners is the nation's largest purchasing cooperative with the most comprehensive portfolio of products and services from industry-leading suppliers. For a full listing of our contract solutions, visit our website at omniapartners.com.



Furniture

- Office Furniture
- Mobile Walls & Space Separation Solutions
- Cafeteria
- Outdoor
- Stadium Seating



Public Safety & Security

- Emergency Telephones
- Temperature Screening
- Facility Management & Infection Control Solutions
- Fire Systems
- Inmate & Detention Supplies
- Security Systems
- Technology Applications
- Video Surveillance
- Cyber Security



Information Technology

- Audio Visual
- Cloud Solutions
- Data Centers
- Data Storage & Management
- Digital Transformation
- Network Communications
- Hardware & Software
- Mobile Computing Solutions
- Laptops & Tablets



Facilities & Construction

- Facilities Services
- Heavy Equipment Rental
- Disaster Recovery & Restoration
- Elevator/Escalator Maintenance
- Flooring
- Roofing
- Auto Parts
- HVAC & Indoor Air Quality
- Janitorial Supplies & Equipment
- Job Order Contracting
- Maintenance, Repair & Operations
- Modular Buildings
- Electrical



Parks & Recreation

- Grounds Maintenance & Equipment
- Fuel & Fuel Card Programs
- Playgrounds & Related Equipment
- Sport Surfaces & Synthetic Turf Field
- Utility Vehicles
- Tractors, Implements & Related Parts
- Food Service Distribution & Equipment



Office Products & Services

- Business Machines
- Document Scanning, Storage & Shredding
- Managed Print Solutions
- Office Products & Equipment
- Paper
- Telecommunications
- Small Parcel



OMNIA Partners is committed to the integrity and transparency of the procurement process. Online access to solicitation and award documentation is always available on the OMNIA Partners website. No FOIA, passwords or special requests are necessary.



436 Seventh Ave, Suite 200
 Pittsburgh, PA 15219
 (888) 851-7094
 Send Payment to: PO Box 646003, Pittsburgh, PA 15264
 salessupportmailbox@carnegielearning.com

QUOTE NO: Q-66397

DATE: 3/27/2026
 EXPIRES ON: 7/31/2026

CONTACT INFORMATION		
Gering Public Schools 1519 10th St. Gering, NE, 69341	Kory Knight Curriculum Coordinator 3084363125 kknight@geringschools.net	Emily Jorgenson Account Executive 520-204-0112 ejorgenson@carnegielearning.com

Level 1

ITEM	DESCRIPTION	TERM	UNITS	NET TOTAL
Deutsch So Aktuell 8e (CLC) - Bundle Level 1	Carnegie Learning German 8e Solution - Bundle (Clear Learning Center)	7 Yrs	42	USD 9,228.70
• Deutsch So Aktuell 8e - Student Edition Level 1	Print Student Edition Textbook		42	Included
• Deutsch So Aktuell 8e - Student Digital Access Level 1	Access to all digital program Student components.	7 Yrs	42	Included
• Destinations Library: German	iCulture + German eReaders + Video Program Treffpunkt Berlin with accompanying student and teacher supplements.	7 Yrs	42	Included
• Deutsch So Aktuell 8e - Annotated Teacher's Edition Level 1	Print Annotated Teacher's Edition		1	Included
• Deutsch Aktuell 8e - Teacher Digital Access (bundled) Level 1	Access to all digital program Teacher components.	7 Yrs	1	Included
Level 1 TOTAL:				USD 9,228.70

Level 2

ITEM	DESCRIPTION	TERM	UNITS	NET TOTAL
Deutsch So Aktuell 8e (CLC) - Bundle Level 2	Carnegie Learning German 8e Solution - Bundle (Clear Learning Center)	7 Yrs	11	USD 2,499.53
• Deutsch So Aktuell 8e - Student Edition Level 2	Print Student Edition Textbook		11	Included
• Deutsch So Aktuell 8e - Student Digital Access Level 2	Access to all digital program Student components.	7 Yrs	11	Included
• Destinations Library: German	iCulture + German eReaders + Video Program Treffpunkt Berlin with accompanying student and teacher supplements.	7 Yrs	11	Included
• Deutsch So Aktuell 8e - Annotated Teacher's Edition Level 2	Print Annotated Teacher's Edition		1	Included
• Deutsch Aktuell 8e - Teacher Digital Access (bundled) Level 2	Access to all digital program Teacher components.	7 Yrs	1	Included
Level 2 TOTAL:				USD 2,499.53

Level 3

ITEM	DESCRIPTION	TERM	UNITS	NET TOTAL
Deutsch So Aktuell 8e (CLC) - Bundle Level 3	Carnegie Learning German 8e Solution - Bundle (Clear Learning Center)	7 Yrs	7	USD 1,631.25
• Deutsch So Aktuell 8e - Student Edition Level 3	Print Student Edition Textbook		7	Included
• Deutsch So Aktuell 8e - Student Digital Access Level 3	Access to all digital program Student components.	7 Yrs	7	Included
• Destinations Library: German	iCulture + German eReaders + Video Program Treffpunkt Berlin with accompanying student and teacher supplements.	7 Yrs	7	Included
• Deutsch So Aktuell 8e - Annotated Teacher's Edition Level 3	Print Annotated Teacher's Edition		1	Included
• Deutsch Aktuell 8e - Teacher Digital Access (bundled) Level 3	Access to all digital program Teacher components.	7 Yrs	1	Included
Level 3 TOTAL:				USD 1,631.25

SUBTOTAL:	USD 13,359.48
SHIPPING AND HANDLING:	USD 434.37
ESTIMATED SALES TAX:	USD 0.00
TOTAL:	USD 13,793.85

TERMS AND CONDITIONS

- The attached quotation is confidential and proprietary information not to be distributed or shared by the Customer.
- By accepting this quote, Customer accepts Carnegie Learning, Inc.'s Terms of Use policy available at: <http://www.carnegielearning.com/terms-of-use>
- Prices are subject to change without notice.
- Quote is valid for 30 days.
- Quoted sales tax is an estimate. Sales Tax is subject to change based on shipping locations and rates at the time of order processing.
- Please include your tax exempt certificate with your purchase order. The Carnegie Learning Federal Tax ID# is 25-1805640.
- Payment Terms: Net 30 Days. Payment of entire invoice amount is required within 30 days from invoice date.
- All media sold by Carnegie Learning, Inc. are sold on a non-returnable basis. The only exceptions to this policy are:
 - Media received that was not ordered (wrong title, wrong quantity). Materials must be in original shrink wrap, if applicable, and not used.
 - Media received in a damaged condition that would render it unsuitable for use.
 - Customer is responsible to inspect textbook shipments and report any textbook quantity, title or damage issues within 45 days of receipt. Failure to report issues within the 45 days could result in additional return fees.
- Carnegie Learning, Inc. is under no obligation to accept return requests after 45 days of customer receipt of order.
- Customer is responsible for expedited shipping costs that fall outside of our standard delivery process. All textbooks carry a standard shipping time frame of 4-6 weeks. Shipments will occur earlier if stock is available.
- Multi-year licenses run consecutively from license activation date.
- The school district is responsible for providing all hardware necessary to run the software, as specified in CLI's Systems Requirements (available at <http://carnegielearning.com/support>). Prices do not include hardware.
- All Professional Development services purchased expire at the term of this agreement. Standalone Professional Development purchases will expire one year from the purchase date.
- An additional credit card fee of 2.5% of total before sales tax will be applied if customer decides to pay by credit card.

- All credit memos and credit balances that exceed 120 days old will first be applied to any existing balances. After application, any remaining credit balance will be refunded via a check. Carnegie Learning will mail the check to the address on file.

EMC SCHOOL AND MONDO EDUCATION ARE PART OF CARNEGIE LEARNING
KOPPERS BLDG, 436 SEVENTH AVE, SUITE 200, PITTSBURGH, PA 15219
Phone 888.851.7094 + Fax 412.690.2444 + www.carnegielearning.com



Quote #101629

Version 1

Valid: Oct 10, 2025 - Jul 31, 2026

Prepared By

Jimmy Moorhead
Lingco Language Labs, Inc.
1146 S Washington Ave
Lansing, MI, 48910
jimmy@lingco.io

Prepared For

Brittany Macias
Gering Public Schools
1519 10th Street
Gering, NE, 69341
bmacias@geringschools.net

Qty	Item Number	Description	Unit Price	Total Value	Total Cost
Lingco for Spanish					
65	979-8-89705-722-1	Lingco for Spanish 1-4: 1-year Student Digital License	\$31.20	\$2,028.00	\$2,028.00
1	979-8-89705-715-3	Lingco for Spanish 1-4: Teacher Digital Access Plus Content Library 1-year License	\$64.00	\$64.00	\$64.00

Total Value: **\$2,092.00**

Total Gratis: **\$0.00**

Grand Total: \$2,092.00



Quote #101629

Version 2

Valid: Oct 10, 2025 - Jul 31, 2026

Prepared By

Jimmy Moorhead
Lingco Language Labs, Inc.
1146 S Washington Ave
Lansing, MI, 48910
jimmy@lingco.io

Prepared For

Brittany Macias
Gering Public Schools
1519 10th Street
Gering, NE, 69341
bmacias@geringschools.net

Qty	Item Number	Description	Unit Price	Total Value	Total Cost
Lingco for Spanish					
65	979-8-89705-721-4	Lingco for Spanish 1-4: 2-year Student Digital License	\$59.28	\$3,853.20	\$3,853.20
1	979-8-89705-714-6	Lingco for Spanish 1-4: Teacher Digital Access Plus Content Library 2-year License	\$121.60	\$121.60	\$121.60

Total Value: **\$3,974.80**

Total Gratis: **\$0.00**

Grand Total: \$3,974.80



Quote #101629

Version 3

Valid: Oct 10, 2025 - Jul 31, 2026

Prepared By

Jimmy Moorhead
Lingco Language Labs, Inc.
1146 S Washington Ave
Lansing, MI, 48910
jimmy@lingco.io

Prepared For

Brittany Macias
Gering Public Schools
1519 10th Street
Gering, NE, 69341
bmacias@geringschools.net

Qty	Item Number	Description	Unit Price	Total Value	Total Cost
Lingco for Spanish					
65	979-8-89705-720-7	Lingco for Spanish 1-4: 3-year Student Digital License	\$84.47	\$5,490.55	\$5,490.55
1	979-8-89705-713-9	Lingco for Spanish 1-4: Teacher Digital Access Plus Content Library 3-year License	\$173.28	\$173.28	\$173.28

Total Value: **\$5,663.83**

Total Gratis: **\$0.00**

Grand Total: \$5,663.83



Quote #101629

Version 4

Valid: Oct 10, 2025 - Jul 31, 2026

Prepared By

Jimmy Moorhead
Lingco Language Labs, Inc.
1146 S Washington Ave
Lansing, MI, 48910
jimmy@lingco.io

Prepared For

Brittany Macias
Gering Public Schools
1519 10th Street
Gering, NE, 69341
bmacias@geringschools.net

Qty	Item Number	Description	Unit Price	Total Value	Total Cost
Lingco for Spanish					
90	979-8-89705-716-0	Lingco for Spanish 1-4: 7-year Student Digital License	\$160.54	\$14,448.60	\$14,448.60
1	979-8-89705-709-2	Lingco for Spanish 1-4: Teacher Digital Access Plus Content Library 7-year License	\$329.32	\$329.32	\$329.32

Total Value: **\$14,777.92**

Total Gratis: **\$0.00**

Grand Total: \$14,777.92



Because learning changes everything.®

QUOTE PREPARED FOR:

Gering Public Schools
1519 10TH ST
GERING, NE 69341-2818
ACCOUNT NUMBER: 325375

SUBSCRIPTION/DIGITAL CONTACT:

Kory Knight
kknight@geringschools.net
(308) 436-3125

CONTACT:

Kory Knight
kknight@geringschools.net
(308) 436-3125

SALES REP INFORMATION:

Jenner Poppe
jenner.poppe@mheducation.com
(402) 203-7323

Section Summary	Value of All Materials	Free Materials	Product Subtotal
INSPIRE BIOLOGY © 2027 (7 Year)	\$20,085.60	(\$534.60)	\$19,551.00
INSPIRE CHEMISTRY © 2027 (7 Year)	\$5,097.81	(\$500.31)	\$4,597.50
Inspire Science © 2020 Earth Science (7 Year)	\$3,758.55	(\$267.30)	\$3,491.25
Inspire Science © 2021 Physical Science (7 Year)	\$20,085.60	(\$534.60)	\$19,551.00
Welsh, Hole's Essentials of Human Anatomy and Physiology, ©2026, 3e	\$7,719.66	(\$327.81)	\$7,391.85
Army, Exploration: An Introduction to Astronomy, 2020, 9e	\$6,247.77	(\$302.67)	\$5,945.10
Professional Development	\$1,500.00	(\$1,500.00)	\$0.00
The Role of the Athletic Trainer in Sports Medicine ©2026	\$4,702.98	(\$207.03)	\$4,495.95
PRODUCT TOTAL*	\$69,197.97	(\$4,174.32)	\$65,023.65
ESTIMATED S&H**			\$1,390.62
ESTIMATED TAX**			\$0.00
GRAND TOTAL*			\$66,414.27

* Price firm for 120 days from quote date. Price quote must be attached to school purchase order to receive the quoted price and free materials.

**Shipping and handling charges shown are only estimates. Actual shipping and handling charges will be applied at time of order. Taxes shown are only estimates. If applicable, actual tax charges will be applied at time of order.

Comments:

PLEASE INCLUDE THIS PROPOSAL WITH YOUR PURCHASE ORDER

SEND ORDER TO:

McGraw Hill LLC | PO Box 182605 | Columbus, OH 43218-2605
Email: orders_mhe@mheducation.com | Phone: 1-800-338-3987 | Fax: 1-800-953-8691

QUOTE DATE: 03/13/2026

ACCOUNT NAME: Gering Public Schools

EXPIRATION DATE: 07/11/2026

QUOTE NUMBER: MGARbutt-03132026100212-001

ACCOUNT #: 325375

PAGE #: 1



Because learning changes everything.®

Product Description	ISBN	Qty	Unit Price	Free Materials	Line Subtotal
INSPIRE BIOLOGY © 2027 (7 Year)					
Digital Only with AL- INSPIRE SCI BIOLOGY G9-12 DIGITAL STUDENT BUNDLE WACTIVELY LEARN SCI 7Y SUB	978-1-26-681677-2	140	\$139.65	\$0.00	\$19,551.00
Teacher Materials					
INSPIRE SCIENCE BIOLOGY GRADES 9-12 ONLINE TEACHER EDITION 7 YEAR SUBSCRIPTION	978-0-07-688707-1	2	\$267.30	\$534.60	*Free Materials
Teacher Materials Subtotal:				\$534.60	\$0.00
INSPIRE BIOLOGY © 2027 (7 Year) Subtotal:				\$534.60	\$19,551.00
INSPIRE CHEMISTRY © 2027 (7 Year)					
INSPIRE SCIENCE 2027 CHEMISTRY COMPREHENSIVE STUDENT BUNDLE INC AL 7Y SUB	978-1-26-668168-4	25	\$183.90	\$0.00	\$4,597.50
Teacher Materials					
INSPIRE CHEMISTRY 2027 TEACHER EDITION	978-1-26-535232-5	1	\$233.01	\$233.01	*Free Materials
INSPIRE SCIENCE CHEMISTRY GRADES 9-12 ONLINE TEACHER EDITION 7 YEAR SUBSCRIPTION	978-0-07-688723-1	1	\$267.30	\$267.30	*Free Materials
Teacher Materials Subtotal:				\$500.31	\$0.00
INSPIRE CHEMISTRY © 2027 (7 Year) Subtotal:				\$500.31	\$4,597.50

PLEASE INCLUDE THIS PROPOSAL WITH YOUR PURCHASE ORDER

SEND ORDER TO:

McGraw Hill LLC | PO Box 182605 | Columbus, OH 43218-2605
Email: orders_mhe@mheducation.com | Phone: 1-800-338-3987 | Fax: 1-800-953-8691

QUOTE DATE: 03/13/2026

ACCOUNT NAME: Gering Public Schools

EXPIRATION DATE: 07/11/2026

QUOTE NUMBER: MGARBUTT-03132026100212-001

ACCOUNT #: 325375

PAGE #: 2



Because learning changes everything.®

Product Description	ISBN	Qty	Unit Price	Free Materials	Line Subtotal
Inspire Science © 2020 Earth Science (7 Year)					
Digital Only with AL- INSPIRE SCI EARTH G9-12 DIGITAL STUDENT BUNDLE WACTIVELY LEARN SCI 7Y SUB	978-1-26-681928-5	25	\$139.65	\$0.00	\$3,491.25
Teacher Materials					
INSPIRE SCIENCE EARTH GRADES 9-12 ONLINE TEACHER EDITION 7 YEAR SUBSCRIPTION	978-0-07-692385-4	1	\$267.30	\$267.30	*Free Materials
Teacher Materials Subtotal:				\$267.30	\$0.00
Inspire Science © 2020 Earth Science (7 Year) Subtotal:				\$267.30	\$3,491.25
Inspire Science © 2021 Physical Science (7 Year)					
Digital Only with AL- INSPIRE SCI PHYSICAL SCI G9-12 DIGITAL STUDENT BUNDLE WACTIVELY LEARN SCI 7Y SUB	978-1-26-681472-3	140	\$139.65	\$0.00	\$19,551.00
Teacher Materials					
INSPIRE SCIENCE PHYSICAL SCIENCE GRADES 9-12 ONLINE TEACHER EDITION 7YR SUBSC	978-0-07-695837-5	2	\$267.30	\$534.60	*Free Materials
Teacher Materials Subtotal:				\$534.60	\$0.00
Inspire Science © 2021 Physical Science (7 Year) Subtotal:				\$534.60	\$19,551.00
Welsh, Hole's Essentials of Human Anatomy and Physiology, ©2026, 3e					
WLSH HLS ESS OF HM ANAT AND PHYS 2026 3E STUDENT BUNDLE WAL SCI 7Y SB	978-1-26-615791-2	25	\$195.09	\$0.00	\$4,877.25
WLSH HLS ESS OF HM ANAT AND PHYS 2026 3E DIGITAL STUDENT BUNDLE WAL SCI 7Y SB	978-1-26-697382-6	15	\$167.64	\$0.00	\$2,514.60
Teacher Materials					
WELSH HOLES ESSENTIALS OF HUMAN ANATOMY AND PHYSIOLOGY 3E 2026 TEACHER MANUAL	978-1-26-692601-3	1	\$57.33	\$57.33	*Free Materials
WELSH HOLES ESSENTIALS OF HUMAN ANATOMY AND PHYSIOLOGY 3E 2026 ONLN TE 7 YEAR	978-1-26-544344-3	1	\$270.48	\$270.48	*Free Materials
Teacher Materials Subtotal:				\$327.81	\$0.00
Welsh, Hole's Essentials of Human Anatomy and Physiology, ©2026, 3e Subtotal:				\$327.81	\$7,391.85
Arny, Exploration: An Introduction to Astronomy, 2020, 9e					
EXPLORATIONS AN INTRODUCTION TO ASTRONOMY STANDARD SE (SE WITH OSE) 7 YR BUNDLE	978-0-07-695330-1	25	\$158.73	\$0.00	\$3,968.25
EXPLORATIONS AN INTRODUCTION TO ASTRONOMY ONLINE STUDENT EDITION 7YSUBSCRIPTION	978-0-07-698748-1	15	\$131.79	\$0.00	\$1,976.85
Teacher Materials					
EXPLORATIONS AN INTRODUCTION TO ASTRONOMY ONLINE TEACHER EDITION 7YRSUBSCRIPTION	978-0-07-698751-1	1	\$302.67	\$302.67	*Free Materials
Teacher Materials Subtotal:				\$302.67	\$0.00
Arny, Exploration: An Introduction to Astronomy, 2020, 9e Subtotal:				\$302.67	\$5,945.10
Professional Development					

PLEASE INCLUDE THIS PROPOSAL WITH YOUR PURCHASE ORDER

SEND ORDER TO:

McGraw Hill LLC | PO Box 182605 | Columbus, OH 43218-2605
 Email: orders_mhe@mheducation.com | Phone: 1-800-338-3987 | Fax: 1-800-953-8691

QUOTE DATE: 03/13/2026

ACCOUNT NAME: Gering Public Schools

EXPIRATION DATE: 07/11/2026

QUOTE NUMBER: MGARBUTT-03132026100212-001

ACCOUNT #: 325375

PAGE #: 3



Because learning changes everything.®

Product Description	ISBN	Qty	Unit Price	Free Materials	Line Subtotal
PROF LRN ONLINE TRAINING 2 HOUR SESSION GRADES 6-12 SCIENCE	978-1-26-422144-8	1	\$1,500.00	\$1,500.00	*Free Materials

Professional Development Subtotal: \$1,500.00 \$0.00

The Role of the Athletic Trainer in Sports Medicine ©2026					
THE ROLE OF THE ATHLTC TRAINER IS SPRTS MDCN 3RD ED STUDENT PRNT ONLN CRS 7Y SUB	978-1-26-682567-5	25	\$157.59	\$0.00	\$3,939.75
ROLE ATHLETIC TRAINER SPORTS MEDICINE 3RD ED STUDENT ONLINE COURSE 7 YR SUBSCR	978-1-26-507847-8	5	\$111.24	\$0.00	\$556.20

Teacher Materials					
ROLE ATHLETIC TRAINER SPORTS MEDICINE 3RD ED TEACHER ONLINE COURSE 7 YR SUBSCR	978-1-26-649967-8	1	\$207.03	\$207.03	*Free Materials

Teacher Materials Subtotal: \$207.03 \$0.00

The Role of the Athletic Trainer in Sports Medicine ©2026 Subtotal: \$207.03 \$4,495.95

PLEASE INCLUDE THIS PROPOSAL WITH YOUR PURCHASE ORDER

SEND ORDER TO:

McGraw Hill LLC | PO Box 182605 | Columbus, OH 43218-2605
Email: orders_mhe@mheducation.com | Phone: 1-800-338-3987 | Fax: 1-800-953-8691

QUOTE DATE: 03/13/2026

ACCOUNT NAME: Gering Public Schools

EXPIRATION DATE:07/11/2026

QUOTE NUMBER: MGARBUTT-03132026100212-001

ACCOUNT #: 325375

PAGE #: 4



Because learning changes everything.®

QUOTE PREPARED FOR:

Gering Public Schools
1519 10TH ST
GERING, NE 69341-2818
ACCOUNT NUMBER: 325375

CONTACT:

Kory Knight
kknight@geringschools.net
(308) 436-3125

VALUE OF ALL MATERIALS	\$69,197.97
FREE MATERIALS	(\$4,174.32)
PRODUCT TOTAL*	\$65,023.65
ESTIMATED SHIPPING & HANDLING**	\$1,390.62
ESTIMATED TAX**	\$0.00
GRAND TOTAL	\$66,414.27

SUBSCRIPTION/DIGITAL CONTACT:

Kory Knight
kknight@geringschools.net
(308) 436-3125

Comments:

* Price firm for 120 days from quote date. Price quote must be attached to school purchase order to receive the quoted price and free materials.

**Shipping and handling charges shown are only estimates. Actual shipping and handling charges will be applied at time of order. Taxes shown are only estimates. If applicable, actual tax charges will be applied at time of order.

Terms of Service:

By placing an order for digital products (the 'Subscribed Materials'), the entity that this price quote has been prepared for ('Subscriber') agrees to be bound by the Terms of Service and any specific provisions required by Subscriber's state law, each located in the applicable links below. Subject to Subscriber's payment of the fees set out above, McGraw Hill LLC hereby grants to Subscriber a non-exclusive, non-transferable license to allow only the number of Authorized Users that corresponds to the quantity of Subscribed Materials set forth above to access and use the Subscribed Materials under the terms described in the Terms of Service and any specific provisions required by Subscriber's state law, each located in the applicable links below. The subscription term for the Subscribed Materials shall be as set forth in the Product Description above. If no subscription term is specified, the initial term shall be one (1) year from the date of this price quote (the 'Initial Subscription Term'), and thereafter the Subscriber shall renew for additional one (1) year terms (each a 'Subscription Renewal Term'), provided MHE has chosen to renew the subscription and has sent an invoice for such Subscription Renewal Term to Subscriber.

[Terms Of Service](#)

[Provisions required by Subscriber State law](#)

ATTENTION: In our effort to protect our customer's data, we will no longer store credit card data in any manner within in our system. Therefore, as of April 30, 2016 we will no longer accept credit card orders via email, fax, or mail/package delivery. Credit card orders may be placed over the phone by calling the number listed above or via our websites by visiting www.mheducation.com (or www.mhecoast2coast.com).

School Purchase Order Number: _____

Name of School Official (Please Print)

Signature of School Official

PLEASE INCLUDE THIS PROPOSAL WITH YOUR PURCHASE ORDER

SEND ORDER TO:

McGraw Hill LLC | PO Box 182605 | Columbus, OH 43218-2605
Email: orders_mhe@mheducation.com | Phone: 1-800-338-3987 | Fax: 1-800-953-8691

QUOTE DATE: 03/13/2026

ACCOUNT NAME: Gering Public Schools

EXPIRATION DATE: 07/11/2026

QUOTE NUMBER: MGARBU-03132026100212-001

ACCOUNT #: 325375

PAGE #: 5

Kesler Science, LLC
 12337 Jones Rd Ste 317
 Houston, TX 77070-4951
 +18327795151
 schools@keslerscience.com



QUOTE

ADDRESS

Gering Public Schools
 1519 10th Street
 Gering, NE 69341

SHIP TO

Gering Public Schools
 1519 10th Street
 Gering, NE 69341

QUOTE # 14303

DATE 04/09/2026

EXPIRATION DATE 10/09/2026

SKU	PRODUCT/SERVICE	QTY	RATE	AMOUNT
KS-PRN-A01	KS Pro:Kesler Science Pro Membership Kesler Science Pro Membership - Year 1 Access	4	579.00	2,316.00
KS-PRN-A01	KS Pro:Kesler Science Pro Membership Kesler Science Pro Membership - Year 2 Access	4	579.00	2,316.00
KS-PRN-MY10	KS Pro:Discount - KS Pro Multi-year Multi-year discount for Year 2	4	-57.90	-231.60
KS-PRN-A01	KS Pro:Kesler Science Pro Membership Kesler Science Pro Membership - Year 3 Access	4	579.00	2,316.00
KS-PRN-MY10	KS Pro:Discount - KS Pro Multi-year Multi-year discount for Year 3	4	-57.90	-231.60
KS-PRN-A01	KS Pro:Kesler Science Pro Membership Kesler Science Pro Membership - Year 4 Access	4	579.00	2,316.00
KS-PRN-MY10	KS Pro:Discount - KS Pro Multi-year Multi-year discount for Year 4	4	-57.90	-231.60
KS-PRN-A01	KS Pro:Kesler Science Pro Membership Kesler Science Pro Membership - Year 5 Access	4	579.00	2,316.00
KS-PRN-MY10	KS Pro:Discount - KS Pro Multi-year Multi-year discount for Year 5	4	-57.90	-231.60
KS-PRN-A01	KS Pro:Kesler Science Pro Membership Kesler Science Pro Membership - Year 6 Access	4	579.00	2,316.00
KS-PRN-MY10	KS Pro:Discount - KS Pro Multi-year Multi-year discount for Year 6	4	-57.90	-231.60
KS-PRN-A01	KS Pro:Kesler Science Pro Membership Kesler Science Pro Membership - Year 7 Access	4	579.00	2,316.00
KS-PRN-MY10	KS Pro:Discount - KS Pro Multi-year Multi-year discount for Year 7	4	-57.90	-231.60
KS-PRN-A01C	KS Pro:Kesler Science Pro Membership - Admin Complimentary Admin Kesler Science Pro Membership - 7 Years of Access	1	0.00	0.00
KS-PDS-A01	Professional Development:PD Session One (1) hour of live virtual professional development - 1 session	1	250.00	250.00

Email schools@keslerscience with any vendor application requirements.

Kesler Science,LLC is an awarded vendor with many Texas co-ops and ISDs; please ask for RFP info.

SKU	PRODUCT/SERVICE	QTY	RATE	AMOUNT
KS-PDS-A01C	per year Professional Development:PD Session (Complimentary) One (1) hour of live virtual professional development (fee waived for 1 session per year)	1	-250.00	-250.00

What is your next step?

TOTAL

\$14,822.40

Forward your purchase order to
schools@keslerscience.com
with this required information:

1. The full name and email address of each user; each teacher needs their own Membership.
2. The full name and email address of the curriculum coordinator or department chair for future follow-ups
3. Your sales tax exemption form

Previous customers, please note this update:
POs are now sent to schools@keslerscience.com.

We do not have a fax machine.

Accepted By

Accepted Date

Email schools@keslerscience with any vendor application requirements.

Kesler Science,LLC is an awarded vendor with many Texas co-ops and ISDs; please ask for RFP info.



Price Quote

Amplify

55 Washington Street, Suite 800
 Brooklyn, NY 11201
 Phone: (800) 823-1969
 Fax: (646) 403-4700

Quote #: Q-731638-1
 PQ #: PQ 251014-491002
 Date: 3/25/2026
 Expires On: 4/24/2026
 Delivery Service Level: Standard

Customer Contact Information

Kory Knight
 Gering Public School Dist 16
 3084363125
 kknight@geringschools.net

Amplify Contact Information

Mason Schroth
 Senior Account Executive
 mschroth@amplify.com

G2-5:
 7 years teacher digital
 7 years student digital
 7 years Student Science Investigation Notebooks

Grade 2

PRODUCT	PRICE	QUANTITY FREE	QUANTITY CHARGE	TOTAL DISCOUNT	TOTAL PRICE
Amplify Science Uvl G2 Dig Exp Teacher License - 7yr (2026-2033)	\$616.00	6	0	\$3,696.00	\$0.00
Amplify Science G2 Dig Exp Student License - 7yr (2026-2033)	\$145.00	125	0	\$18,125.00	\$0.00
Amplify Science G2 Kits	\$2,555.00	0	6	\$0.00	\$15,330.00
Amplify Science G2 Student Investigation NB Set	\$8.97	0	875	\$1,181.25	\$6,667.50
Amplify Science Uvl G2 Teacher Guide Set	\$140.00	6	0	\$840.00	\$0.00
TOTAL				\$23,842.25	\$21,997.50

Grade 3

PRODUCT	PRICE	QUANTITY FREE	QUANTITY CHARGE	TOTAL DISCOUNT	TOTAL PRICE
Amplify Science Uvl G3 Dig Exp Teacher License - 7yr (2026-2033)	\$616.00	6	0	\$3,696.00	\$0.00
Amplify Science G3 Dig Exp Student License - 7yr (2026-2033)	\$145.00	140	0	\$20,300.00	\$0.00
Amplify Science G3 Kits	\$4,175.00	0	6	\$0.00	\$25,050.00
Amplify Science G3 Student Investigation NB Set	\$11.96	0	980	\$1,764.00	\$9,956.80

PRODUCT	PRICE	QUANTITY FREE	QUANTITY CHARGE	TOTAL DISCOUNT	TOTAL PRICE
Amplify Science Uvl G3 Teacher Guide Set	\$180.00	6	0	\$1,080.00	\$0.00
TOTAL				\$26,840.00	\$35,006.80

Grade 4

PRODUCT	PRICE	QUANTITY FREE	QUANTITY CHARGE	TOTAL DISCOUNT	TOTAL PRICE
Amplify Science Uvl G4 Dig Exp Teacher License - 7yr (2026-2033)	\$616.00	6	0	\$3,696.00	\$0.00
Amplify Science G4 Dig Exp Student License - 7yr (2026-2033)	\$145.00	150	0	\$21,750.00	\$0.00
Amplify Science G4 Kits	\$3,440.00	0	6	\$0.00	\$20,640.00
Amplify Science G4 Student Investigation NB Set	\$11.96	0	1,050	\$1,890.00	\$10,668.00
Amplify Science Uvl G4 Teacher Guide Set	\$180.00	6	0	\$1,080.00	\$0.00
TOTAL				\$28,416.00	\$31,308.00

Grade 5

PRODUCT	PRICE	QUANTITY FREE	QUANTITY CHARGE	TOTAL DISCOUNT	TOTAL PRICE
Amplify Science Uvl G5 Dig Exp Teacher License - 7yr (2026-2033)	\$616.00	6	0	\$3,696.00	\$0.00
Amplify Science G5 Dig Exp Student License - 7yr (2026-2033)	\$145.00	120	0	\$17,400.00	\$0.00
Amplify Science G5 Kits	\$3,115.00	0	6	\$0.00	\$18,690.00
Amplify Science G5 Student Investigation NB Set	\$11.96	0	840	\$1,512.00	\$8,534.40
Amplify Science Uvl G5 Teacher Guide Set	\$180.00	6	0	\$1,080.00	\$0.00
TOTAL				\$23,688.00	\$27,224.40

Please refer to Product Description section below for more detail.

Professional Development

PROFESSIONAL DEVELOPMENT	QUANTITY	PRICE	TOTAL DISCOUNT	TOTAL PRICE
Amplify Science GK-5 Program Overview for Teachers (1/2 Day Remote)	1.00	\$750.00	\$0.00	\$750.00
TOTAL		\$750.00	\$0.00	\$750.00

Shipping & Handling

SHIPPING AND HANDLING	DELIVERY SERVICE LEVEL	SHIPPING COST	TOTAL DISCOUNT	TOTAL PRICE
Amplify Shipping and Handling	Standard	\$16,808.27	\$0.00	\$16,808.27

TOTAL DISCOUNT \$102,786.25
 GRAND TOTAL \$133,094.97

Scope and Duration

Payment Terms:

- This Price Quote (including all pricing and other terms) is valid through Quote Expiration Date stated above.
- Payment terms: net 30 days.
- Prices do not include sales tax, if applicable.
- Pricing terms in the Price Quote are based on the scope of purchase and other terms herein.
- The Federal Tax ID # for Amplify Education, Inc. is 13-4125483. A copy of Amplify's W-9 can be found at: <http://www.amplify.com/w-9.pdf>

License and Services Term:

- Licenses: 07/01/2026 until 06/30/2033.
- Professional Development (PD) Services:
 - For purchases made on or before 12/31/25, unless otherwise stated above, PD Services expire 18 months from the order date. Any unused PD Services after 18 months will be forfeited.
 - For purchases on or after 1/1/26, please visit <http://amplify.com/pd-expirationterms> for information about the term for PD Services and when they expire, unless otherwise outlined herein.
- All other services: 18 months from order date. Unless otherwise stated above, all other services purchased must be scheduled and delivered within such term or will be forfeited.

Special Terms:

- FOR SHIPPED MATERIALS:
 - Print materials and kits are non-returnable and non-refundable, except in the case of defective or missing materials reported by Customer within 60 days of receipt.
- FOR SERVICES:
 - Training and professional development sessions cancelled with less than one week notice will be deemed delivered.

Quote Special Terms

Free-with-Order Teacher Digital Experience License with Kit

Please note that the above pricing reflects the receipt of one Elementary Teacher Digital Experience License free-with-order with the purchase of a Classroom Kit for the duration of the adoption. License duration shown appended to Classroom Kits.

Free-with-Order Science Teacher Guides

Please note that the above pricing reflects the availability of free-with-order print teacher guides in proportion to the purchase of licenses, materials kits, and print student investigation notebooks for entire classroom.

Science Dig Exp Included with Kit

Please note that the above pricing reflects the receipt of a class set of 36 Student Digital Experience Licenses, included with every purchase of a grade level set of K-5 Science Kits.

Product Descriptions

Grade 2

PRODUCT	DESCRIPTION
Amplify Science Uvl G2 Dig Exp Teacher License	Digital Experience Teacher License for all Amplify Science Second Grade units: Plant and Animal Relationships, Properties of Materials, and Changing Landforms
Amplify Science G2 Dig Exp Student License	Amplify Science Grade 2 Digital Experience Student License includes access digital resources including the digital library, student investigation notebooks (PDF), and digital at-home instructional materials for the following units: Plant and Animal Relationships, Properties of Materials, and Changing Landforms
Amplify Science G2 Kits	Includes one kit for all Grade 2 units (two sets of consumable materials for 36 students): Earth Science Unit - Changing Landforms, Life Science Unit - Plant and Animal Relationships, and Physical Science Unit - Properties of Materials.
Amplify Science G2 Student Investigation NB Set	Includes one student investigation notebook for each of the Grade 2 units: Earth Science Unit - Changing Landforms, Life Science Unit - Plant and Animal Relationships, and Physical Science Unit - Properties of Materials.
Amplify Science G2 Student Investigation NB: Properties of Materials	Student Investigation Notebook for the Amplify Science G2 Physical Science: Properties of Materials unit.
Amplify Science G2 Student Investigation NB: Plant and Animal Relationships	Student Investigation Notebook for the Amplify Science G2 Life Science: Plant and Animal Relationships unit.
Amplify Science G2 Student Investigation NB: Changing Landforms	Student Investigation Notebook for the Amplify Science G2 Earth Science: Changing Landforms unit.
Amplify Science Uvl G2 Teacher Guide Set	Includes one Amplify Science Uvl G2 Changing Landforms Teacher Guide, one Amplify Science Uvl G2 Plant and Animal Relationships Teacher Guide, and one Amplify Science Uvl G2 Properties of Materials Teacher Guide.

Grade 3

PRODUCT	DESCRIPTION
Amplify Science Uvl G3 Dig Exp Teacher License	Digital Experience Teacher License for all Amplify Science Third Grade units: Balancing Forces, Environments and Survival, Inheritance and Traits, and Weather and Climate
Amplify Science G3 Dig Exp Student License	Amplify Science Grade 3 Digital Experience Student License includes access digital resources including the digital library, simulations, student investigation notebooks (PDF), digital at-home instructional materials, and assessments (PDF or QTI) for the following units: Balancing Forces, Inheritance and Traits, Environments and Survival, and Weather and Climate
Amplify Science G3 Kits	Includes one kit for all Grade 3 units (two sets of consumable materials for 36 students): Earth Science Unit - Weather and Climate, Life Science Unit A - Inheritance and Traits, Life Science Unit B - Environments and Survival, and Physical Science Unit - Balancing Forces.

PRODUCT	DESCRIPTION
Amplify Science G3 Student Investigation NB Set	Includes one student investigation notebook for each of the Grade 3 units: Earth Science Unit - Weather and Climate, Life Science Unit A - Inheritance and Traits, Life Science Unit B - Environments and Survival, and Physical Science Unit - Balancing Forces.
Amplify Science G3 Student Investigation NB: Weather and Climate	Student Investigation Notebook for the Amplify Science G3 Earth Science: Weather and Climate unit.
Amplify Science G3 Student Investigation NB: Balancing Forces	Student Investigation Notebook for the Amplify Science G3 Physical Science: Balancing Forces unit.
Amplify Science G3 Student Investigation NB: Inheritance and Traits	Student Investigation Notebook for the Amplify Science G3 Life Science: Inheritance and Traits unit.
Amplify Science G3 Student Investigation NB: Environments and Survival	Student Investigation Notebook for the Amplify Science G3 Life Science: Environments and Survival unit.
Amplify Science Uvl G3 Teacher Guide Set	Includes one Amplify Science Uvl G3 Weather and Climate Teacher Guide, one Amplify Science Uvl G3 Inheritance and Traits Teacher Guide, one Amplify Science Uvl G3 Environments and Survival Teacher Guide, and one Amplify Science Uvl G3 Balancing Forces Teacher Guide.

Grade 4

PRODUCT	DESCRIPTION
Amplify Science Uvl G4 Dig Exp Teacher License	Digital Experience Teacher License for all Amplify Science Fourth Grade units: Energy Conversions, Vision and Light, Earth's Features, and Waves, Energy, and Information
Amplify Science G4 Dig Exp Student License	Amplify Science Grade 4 Digital Experience Student License includes access digital resources including the digital library, simulations, student investigation notebooks (PDF), digital at-home instructional materials, and assessments (PDF or QTI) for the following units: Energy Conversions, Vision and Light, Earth's Features, Waves, Energy, and Information
Amplify Science G4 Kits	Includes one kit for all Grade 4 units (two sets of consumable materials for 36 students): Earth Science Unit - Earth's Features, Life Science Unit - Vision and Light, Physical Science Unit A - Energy Conversions, and Physical Science Unit B - Waves, Energy, and Information.
Amplify Science G4 Student Investigation NB Set	Includes one student investigation notebook for each of the Grade 4 units: Earth Science Unit - Earth's Features, Life Science Unit - Vision and Light, Physical Science Unit A - Energy Conversions, and Physical Science Unit B - Waves, Energy, and Information.
Amplify Science G4 Student Investigation NB: Earth's Features	Student Investigation Notebook for the Amplify Science G4 Earth Science: Earth's Features unit.
Amplify Science G4 Student Investigation NB: Vision and Light	Student Investigation Notebook for the Amplify Science G4 Life Science: Vision and Light unit.
Amplify Science G4 Student Investigation NB: Energy Conversions	Student Investigation Notebook for the Amplify Science G4 Life Science: Energy Conversions unit.

PRODUCT	DESCRIPTION
Amplify Science G4 Student Investigation NB: Waves, Energy, and Information	Student Investigation Notebook for the Amplify Science G4 Physical Science: Waves, Energy, and Information unit.
Amplify Science Uvl G4 Teacher Guide Set	Includes one Amplify Science Uvl G4 Earth's Features Teacher Guide, one Amplify Science Uvl G4 Vision and Light Teacher Guide, one Amplify Science Uvl G4 Energy Conversions Teacher Guide, and one Amplify Science Uvl G4 Waves, Energy, and Information Teacher Guide.

Grade 5

PRODUCT	DESCRIPTION
Amplify Science Uvl G5 Dig Exp Teacher License	Digital Experience Teacher License for all Amplify Science Fifth Grade units: Patterns of Earth and Sky, Modeling Matter, The Earth System, and Ecosystem Restoration
Amplify Science G5 Dig Exp Student License	Amplify Science Grade 5 Digital Experience Student License includes access digital resources including the digital library, simulations, student investigation notebooks (PDF), digital at-home instructional materials, and assessments (PDF or QTI) for the following units: Patterns of Earth and Sky, Modeling Matter, The Earth System, and Ecosystem Restoration
Amplify Science G5 Kits	Includes one kit for all Grade 5 units (two sets of consumable materials for 36 students): Earth Science Unit A - Patterns of Earth and Sky, Earth Science Unit B - The Earth System, Life Science Unit - Ecosystem Restoration, and Physical Science Unit - Modeling Matter.
Amplify Science G5 Student Investigation NB Set	Includes one student investigation notebook for each of the Grade 5 units: Earth Science Unit A - Patterns of Earth and Sky, Earth Science Unit B - The Earth System, Life Science Unit - Ecosystem Restoration, and Physical Science Unit - Modeling Matter.
Amplify Science G5 Student Investigation NB: Patterns of Earth and Sky	Student Investigation Notebook for the Amplify Science G5 Earth Science: Patterns of Earth and Sky unit.
Amplify Science G5 Student Investigation NB: The Earth System	Student Investigation Notebook for the Amplify Science G5 Earth Science: The Earth System unit.
Amplify Science G5 Student Investigation NB: Ecosystem Restoration	Student Investigation Notebook for the Amplify Science G5 Life Science: Ecosystem Restoration unit.
Amplify Science G5 Student Investigation NB: Modeling Matter	Student Investigation Notebook for the Amplify Science G5 Physical Science: Modeling Matter unit.
Amplify Science Uvl G5 Teacher Guide Set	Includes one Amplify Science Uvl G5 Patterns of Earth and Sky Teacher Guide, one Amplify Science Uvl G5 The Earth System Teacher Guide, one Amplify Science Uvl G5 Ecosystem Restoration Teacher Guide, and one Amplify Science Uvl G5 Modeling Matter Teacher Guide.

Professional Development

PRODUCT	DESCRIPTION
Amplify Science GK-5 Program Overview for Teachers (1/2 Day Remote)	This session prepares educators who are new to Amplify Science to effectively implement Amplify Science K-5. Learn the program overview for getting started with Amplify Science. Features an exemplar from a unit and allows educators to experience an exemplar lesson. The maximum number of participants is 30.

How to Order Our Products

Amplify would like to process your order as quickly as possible. We accept: **Purchase Orders** (fastest), **Credit Cards**, **ACH/Wire**, and **Checks**.

Visit [amplify.com/ordering-support](https://www.amplify.com/ordering-support) for ordering instructions.

Option 1: Purchase Order (For Fastest Processing, we recommend you submit a purchase order via our website: [amplify.com/ordering-support](https://www.amplify.com/ordering-support))

Submit your signed purchase order using any method below:

- **Online:** service.amplify.com/submit-a-po
- **Email:** IncomingPO@amplify.com
- **Fax:** (646) 403-4700

Required with your Purchase Order:

- Copy of your Price Quote
- Tax-Exemption Certificate (if applicable)

Option 2: Pay in Advance

- **Credit Card:** Visit service.amplify.com/make-a-payment
- **ACH/Wire:** Visit service.amplify.com/make-a-payment for Amplify banking details
- **Check:**

Amplify Education, Inc.
P.O. Box 392294
Pittsburgh, PA 15251-9294

Note: To ensure timely and accurate processing, customers making Wire or ACH payments must email remittance details to accountsreceivable@amplify.com. If paying by check, include your quote number on your check. Check payments add up to 2 weeks processing time.

Important: Sales tax is not included in quotes and may apply to your order. Please notify your sales representative of any prepayments and their details.

This Price Quote is subject to the Customer Terms & Conditions of Amplify Education, Inc. attached and available at [amplify.com/customer-terms](https://www.amplify.com/customer-terms). Issuance of a purchase order or payment pursuant to this Price Quote, or usage of the products specified herein, shall be deemed acceptance of such Terms & Conditions.

Terms & Conditions

1. Scope. These Customer Terms and Conditions are a legal agreement between Amplify Education, Inc. (“Amplify”) and the local education agency or authority, school district, school network, independent school, or other regional education system (“Customer”) for the license and use of one or more of Amplify products or services (the “Products”), as specified in the receipt, price quote, proposal, renewal letter, or other ordering document containing the details of this purchase (the “Quote”). These Customer Terms and Conditions, all addenda, attachments, and the Quote, as applicable (together, the “Agreement”), constitute the entire agreement between the parties relating to the subject matter hereof. The provisions of this Agreement will supersede any conflicting terms and conditions in any Customer purchase order, other correspondence or verbal communication, and will supersede and cancel all prior agreements, written or oral, between the parties relating to the subject matter hereof.

2. Agreement Acceptance. This Agreement becomes effective at the earliest of the following: (i) issuing a purchase order, shipment request, or payment against the Quote; (ii) accessing, downloading, or using the Products; or (iii) otherwise accepting this Agreement. This term of the Agreement will be as specified in the Quote and may be renewed or extended by mutual agreement of the parties. Customer represents and warrants that: (1) Customer is of legal age to accept this Agreement; (2) Customer is authorized to accept this Agreement and to access and use the Products; and (3) Customer’s use of the Products will comply at all times with Amplify’s [Acceptable Use Policy](#) available at [amplify.com/acceptable-use](#) (“AUP”). The Customer may not access, download, or use the Products if the Customer does not agree to this Agreement.

3. License. Subject to the terms and conditions of the Agreement, Amplify grants to Customer a non-exclusive, non-transferable, non-sublicensable license to access and use, and permit Authorized School Users, as defined below, to access and use the Products in accordance with the AUP, for the duration specified in the Quote (the “Term”), and for the number of Authorized School Users specified in the Quote for whom Customer has paid the applicable fees to Amplify. “Authorized School User” means the K–12 students registered or authorized for instruction with Customer and the educators, agents and staff members who use the Products as authorized by Customer who Customer permits to access and use the Products subject to the terms and conditions of the Agreement, solely while such individual is so employed or so registered. Each Authorized School User’s access and use of the Products will be subject to the AUP in addition to the terms and conditions of the Agreement. Violations of this Agreement or the AUP may result in suspension or termination of the applicable account.

4. Restrictions. Customer may access and use the Products solely for non-commercial instructional and administrative purposes. Guidelines for such purposes may be set forth at [https://amplify.com/amplify-program-usage-guidelines/](#) and additional guidelines may be detailed in materials associated with the Product the Customer is accessing. Further, Customer may not, except as expressly authorized by Amplify: (a) copy, modify, translate, distribute, disclose, or create derivative works based on the contents of, sell, or otherwise exploit, the Products, or any part thereof; (b) decompile, disassemble, reverse engineer the Products, or otherwise use the Products to develop functionally similar products or services; (c) modify, alter, or delete any of the copyright, trademark, or other proprietary notices in or on the Products; (d) rent, lease, or lend the Products or use the Products for the benefit of any third party; (e) avoid, circumvent, or disable any security or digital rights management device, procedure, protocol, or mechanism in the Products; (f) use any content from the Products, including but not limited to text, images, videos, assessments, lesson plans, or code, as input or training material for any machine learning or artificial intelligence system, including large language models, neural networks, or other algorithmic models, for any purposes, commercial or non-commercial; or (g) permit any Authorized School User or third party to do any of the foregoing. Customer also agrees that any works created in violation of this section are derivative works, and, as such, Customer agrees to assign, and hereby assigns, all right, title, and interest in such works to Amplify. The Products and derivatives thereof may be subject to export control laws, restrictions, regulations, and orders of the U.S. and other jurisdictions (together, “Export Laws”). Customer agrees to comply with all applicable Export Laws, and will not, and will not permit Authorized School Users to, export, or transfer for the purpose of re-export, any Product to any prohibited or embargoed country in violation of any U.S. export law or regulation. Further, Customer represents that it is not a party subject to sanctions by the U.S. Office of Foreign Assets Control or included on any restricted party list maintained by the U.S. Bureau of Industry and Security. The software and associated documentation portions of the Products are “commercial items” (as defined at 48 CFR 2.101), comprising “commercial computer software” and “commercial computer software documentation,” as those terms are used in 48 CFR 12.212. Accordingly, if Customer is the U.S. Government or its contractor, Customer will receive only those rights set forth in this Agreement in accordance with 48 CFR 227.7201-227.7204 (for Department of Defense and their contractors) or 48 CFR 12.212 (for other U.S. Government licensees and their contractors).

5. Reservation of Rights. SUBSCRIPTION PRODUCTS ARE LICENSED, NOT SOLD. Subject to the limited rights expressly granted hereunder, all rights, title, and interest in and to all Products, including all related IP Rights, are and will remain the sole and exclusive property of Amplify or its third-party licensors. “IP Rights” means, collectively, rights under patent, trademark, copyright, and trade secret laws, and any other intellectual property or proprietary rights recognized in any country or jurisdiction worldwide. Customer must promptly notify Amplify of any violation of Amplify’s IP Rights in the Products, and will reasonably assist Amplify as necessary to remedy any such violation. Amplify Products are protected by patents (see [amplify.com/virtual-patent-marking](#)). Amplify reserves the right to update or modify the Products at any time and to discontinue the Products upon reasonable notice.

6. Payments. In consideration of the Products, Customer will pay to Amplify (or other party designated on the Quote) the fees specified in the Quote in full within 30 days of the date of invoice, except as otherwise agreed by the parties or for those amounts that are subject to a good faith dispute of which Customer has notified Amplify in writing. Customer will be responsible for all state or local sales, use or gross receipts taxes, and federal excise taxes unless Customer provides a then-current tax exemption certificate in advance of the delivery, license, or performance of any Product, as applicable.

7. Shipments. Unless otherwise specified on the Quote, physical Products will be shipped FOB origin in the US (Incoterms 2010 EXW outside of the US) and are deemed accepted by Customer upon receipt. Upon acceptance of such Products, orders are non-refundable, non-returnable, and non-exchangeable, except in the case of defective or missing materials reported to Amplify by Customer within 60 days of receipt. In such case, Customer may not return Products without Amplify's written authorization.

8. Account Information. For subscription Products, the authentication of Authorized School Users is based in part upon information supplied by Customer or Authorized School Users, as applicable. Customer will and will cause its Authorized School Users to (a) provide accurate information to Amplify or a third-party service as applicable, and promptly report any changes to such information, (b) not share login credentials or otherwise allow others to use their account, (c) maintain the confidentiality and security of their account information, and (d) use the Products solely via such authorized accounts. Customer agrees to notify Amplify immediately of any unauthorized use of its or its Authorized School Users' accounts or related authentication information. Amplify will not be responsible for any losses arising out of the unauthorized use of accounts created by or for Customer and its Authorized School Users.

9. Confidentiality. Customer acknowledges that, in connection with this Agreement, Amplify has provided or will provide to Customer and its Authorized School Users certain sensitive or proprietary information, including software, source code, assessment instruments, research, designs, methods, processes, customer lists, training materials, product documentation, know-how, or trade secrets, in whatever form ("Confidential Information"). Customer agrees (a) not to use Confidential Information for any purpose other than use of the Products in accordance with this Agreement and (b) to take all steps reasonably necessary to maintain and protect the Confidential Information of Amplify in strict confidence. Confidential Information shall not include information that, as evidenced by Customer's contemporaneous written records: (i) is or becomes publicly available through no fault of Customer; (ii) is rightfully known to Customer prior to the time of its disclosure; (iii) has been independently developed by Customer without any use of the Confidential Information; or (iv) is subsequently learned from a third party not under any confidentiality obligation.

10. Student Data. The parties acknowledge and agree that in the course of providing the Products to the Customer, Amplify may collect, receive, or generate information that directly relates to an identifiable student of Customer ("Student Data"). Student Data may include personal information from a student's "educational records," as defined by the Family Educational Rights and Privacy Act of 1974 ("FERPA"). Student Data is owned and controlled by the Customer and Amplify receives Student Data as a "school official" under Section 99.31 of FERPA for the purpose of providing the Products hereunder. Individually and collectively, Amplify and Customer agree to uphold our obligations, as applicable, under FERPA, the Children's Online Privacy Protection Act ("COPPA"), the Protection of Pupil Rights Amendment ("PPRA"), and applicable state laws relating to student data privacy. Amplify's Customer [Privacy Policy](#) at amplify.com/customer-privacy ("Privacy Policy") will govern collection, use, and disclosure of Student Data collected or stored on behalf of Customer under this Agreement. In addition, Amplify has entered into the data privacy agreements listed at amplify.com/privacy-security aligned with state and national templates to facilitate compliance with applicable state laws and help expedite Customer's student data privacy documentation process. Customer is responsible for providing notice and obtaining appropriate consents under applicable laws to authorize Authorized School Users' use of the Products, including making a copy of the [Privacy Policy](#) available to the parents or guardians of users who are under the age of 13.

11. Customer Materials and Requirements. Customer represents, warrants, and covenants that it has all the necessary rights, including consents and IP Rights, in connection with any data, information, content, and other materials provided to or collected by Amplify on behalf of Customer or its Authorized School Users using the Products or otherwise in connection with this Agreement ("Customer Materials"), and that Amplify has the right to use such Customer Materials as contemplated hereunder or for any other purposes required by Customer. Customer is solely responsible for the accuracy, integrity, completeness, quality, legality, and safety of such Customer Materials. Customer is responsible for meeting hardware, software, telecommunications, and other requirements listed at amplify.com/customer-requirements.

12. Warranty Disclaimer. PRODUCTS ARE PROVIDED "AS IS" AND WITHOUT WARRANTY OF ANY KIND BY AMPLIFY. AMPLIFY EXPRESSLY DISCLAIMS ALL WARRANTIES, EXPRESS OR IMPLIED, INCLUDING ANY WARRANTY AS TO TITLE, NON-INFRINGEMENT, MERCHANTABILITY, OR FITNESS FOR A PARTICULAR PURPOSE OR USE. CUSTOMER ASSUMES RESPONSIBILITY FOR SELECTING THE PRODUCTS TO ACHIEVE CUSTOMER'S INTENDED RESULTS AND FOR THE ACCESS AND USE OF THE PRODUCTS, INCLUDING THE RESULTS OBTAINED FROM THE PRODUCTS. WITHOUT LIMITING THE FOREGOING, AMPLIFY MAKES NO WARRANTY THAT THE PRODUCTS WILL BE ERROR-FREE OR FREE FROM

INTERRUPTIONS OR OTHER FAILURES OR WILL MEET CUSTOMER'S REQUIREMENTS. AMPLIFY IS NEITHER RESPONSIBLE NOR LIABLE FOR ANY THIRD-PARTY CONTENT OR SOFTWARE INCLUDED IN PRODUCTS, INCLUDING THE ACCURACY, INTEGRITY, COMPLETENESS, QUALITY, LEGALITY, USEFULNESS, OR SAFETY OF, OR IP RIGHTS RELATING TO, SUCH THIRD-PARTY CONTENT AND SOFTWARE. ANY ACCESS TO OR USE OF SUCH THIRD-PARTY CONTENT AND SOFTWARE MAY BE SUBJECT TO THE TERMS AND CONDITIONS AND INFORMATION COLLECTION, USAGE, AND DISCLOSURE PRACTICES OF THIRD PARTIES.

13. **Limitation of Liability.** TO THE EXTENT SUCH LIMITATION IS NOT PROHIBITED BY APPLICABLE LAW, IN NO EVENT WILL AMPLIFY BE LIABLE TO CUSTOMER OR TO ANY AUTHORIZED SCHOOL USER FOR ANY INCIDENTAL, SPECIAL, CONSEQUENTIAL, PUNITIVE, RELIANCE, OR COVER DAMAGES, DAMAGES FOR LOST PROFITS, LOST DATA OR LOST BUSINESS, OR ANY OTHER INDIRECT DAMAGES, EVEN IF AMPLIFY HAS BEEN ADVISED OF THE POSSIBILITY OF SUCH DAMAGES. TO THE EXTENT SUCH LIMITATION IS NOT PROHIBITED BY APPLICABLE LAW, AMPLIFY'S ENTIRE LIABILITY TO CUSTOMER OR ANY AUTHORIZED USER ARISING OUT OF PERFORMANCE OR NONPERFORMANCE BY AMPLIFY OR IN ANY WAY RELATED TO THE SUBJECT MATTER OF THIS AGREEMENT, REGARDLESS OF WHETHER THE CLAIM FOR SUCH DAMAGES IS BASED IN CONTRACT, TORT, STRICT LIABILITY, OR OTHERWISE, MAY NOT EXCEED THE AGGREGATE OF CUSTOMER'S OR ANY AUTHORIZED USER'S DIRECT DAMAGES UP TO THE FEES PAID BY CUSTOMER TO AMPLIFY FOR THE AFFECTED PORTION OF THE PRODUCTS IN THE PRIOR 12-MONTH PERIOD. UNDER NO CIRCUMSTANCES WILL AMPLIFY BE LIABLE FOR ANY CONSEQUENCES OF ANY UNAUTHORIZED USE OF THE PRODUCTS BY AN AUTHORIZED SCHOOL USER THAT VIOLATES THIS AGREEMENT OR ANY APPLICABLE LAW OR REGULATION.

14. **Termination.** Without prejudice to any rights either party may have under this Agreement, in law, equity, or otherwise, a party will have the right to terminate this Agreement if the other party (or in the case of Amplify, an Authorized School User) materially breaches any term, provision, warranty, or representation under this Agreement and fails to correct the breach within 30 days of its receipt of written notice thereof. Upon termination, Customer will: (a) cease using the Products, (b) return, purge, or destroy (as directed by Amplify) all copies of any Products and, if so requested, certify to Amplify in writing that such surrender or destruction has occurred, (c) pay any fees due and owing hereunder, and (d) not be entitled to a refund of any fees previously paid, unless otherwise specified in the Quote. Customer will be responsible for the cost of any continued use of the Products following termination. Upon termination, Amplify will return or destroy any Student Data provided to Amplify hereunder. Notwithstanding the foregoing, nothing will require Amplify to return or destroy any data that does not include Student Data, including de-identified information or data that is derived from access to Student Data but which does not contain Student Data. Sections 3–14 will survive the termination of this Agreement.

15.

Miscellaneous. This Agreement may not be modified except in writing signed by both parties. All defined terms in this Agreement will apply to their singular and plural forms, as applicable. The word "including" means "including without limitation." For United States-based Customers, this Agreement will be governed by and construed and enforced in accordance with the laws of the U.S., state, commonwealth, or territory in which Customer resides based on the address set forth in the Quote, without regard to that state's, commonwealth's, or territory's choice of law rules. For Customers based outside of the United States, this Agreement will be governed by the laws of the U.S., state of New York, without giving effect to the choice of law rules thereof. This Agreement will be binding upon and inure to the benefit of the parties and their respective successors and assigns. The parties expressly understand and agree that their relationship is that of independent contractors. Nothing in this Agreement will constitute one party as an employee, agent, joint venture partner, or servant of another. Each party is solely responsible for all of its employees and agents and its labor costs and expenses arising in connection herewith. Neither this Agreement nor any of the rights, interests or obligations hereunder may be assigned or delegated by Customer or any Authorized School User without the prior written consent of Amplify. If one or more of the provisions contained in this Agreement will for any reason be held to be unenforceable at law, such provisions will be construed by the appropriate judicial body to limit or reduce such provision or provisions so as to be enforceable to the maximum extent compatible with applicable law. Amplify will have no liability to Customer or to third parties for any failure or delay in performing any obligation under this Agreement due to circumstances beyond its reasonable control, including acts of God or nature, fire, earthquake, flood, epidemic, pandemic, strikes, labor stoppages or slowdowns, civil disturbances or terrorism, national or regional emergencies, supply shortages or delays, action by any governmental authority, or interruptions in power, communications, satellites, the Internet, or any other network. Each party represents and warrants that it has all necessary right, power, and authority to enter into this Agreement and to comply with the obligations hereunder.

We are delighted to work with you and we thank you for your order!

