

Workshop/Action Meeting
Monday, April 21, 2025 5:30 PM

Education Support Center
2218 FM 517
Dickinson, TX 77539

Agenda

1. Roll Call, Establish Quorum, Welcome Visitors
2. Public Comment: Agenda Items
3. Open Forum: Non agenda Items
4. Closed Executive Session
 - 4.A. Section 551.071 - Consultation with attorney
 - 4.B. Section 551.071; 551.074 - Consider and Discuss the Appeal of the Proposed Non-Renewal of a Term Contract Employee at Barber Middle School
 - 4.C. Section 551.071; 551.074 - Deliberate and Consult with legal counsel regarding recommendation to propose non-renewal of term contract teacher at Kranz Junior High School
 - 4.D. Section 551.071; 551.074 -Deliberate and Consult with legal counsel regarding Termination of the Probationary Contracts of Two (2) Teachers at McAdams Junior High School
5. Action on Closed Executive Session Items
 - 5.A. Consider, discuss, and potentially take action on the Appeal of the Proposed Non-Renewal of a Term Contract Employee at Barber Middle School
 - 5.B. Consider, discuss, and potentially take action on the administration's proposal to recommend non-renewal of term contract of teacher at Kranz Junior High School
 - 5.C. Consider, discuss, and potentially take action on the administration's proposal to Terminate the Probationary Contract of a Teacher at McAdams Junior High School
 - 5.D. Consider, discuss, and potentially take action on the administration's proposal to Terminate the Probationary Contract of a Teacher at McAdams Junior High School
6. Front Entry Security Camera Project
7. GMP #1 CTE Building
8. Closed Executive Session
 - 8.A. Section 551.074 - Personnel Matters
 - 8.B. Section 551.072 - Real Property
 - 8.C. Section 551.076 - Security
9. Adjournment

DICKINSON INDEPENDENT SCHOOL DISTRICT BOARD AGENDA DOCUMENT

Item Title: Public Comment: Agenda Items

Agenda Item: Dr. Rebecca Brown

Background Information:

The Board will hear from those in the audience who have completed the document for permission to address the Board this evening regarding agenda items per HB 2840. The Board President or Secretary will ask the individuals to speak in the order in which the completed document was received.

DICKINSON INDEPENDENT SCHOOL DISTRICT BOARD AGENDA DOCUMENT

Item Title: Open Forum

Agenda Item: Dr. Rebecca Brown

Background Information:

The Board will hear from those in the audience who have completed the document for permission to address the Board this evening. The Board President or Secretary will ask the individuals to speak in the order in which the completed document was received. Each will be limited to no more than three minutes. No one may begin addressing the Board thirty minutes from this time.

DICKINSON INDEPENDENT SCHOOL DISTRICT

EXECUTIVE BOARD AGENDA DOCUMENT

Meeting Date: April 21, 2025

Item Title: Executive Session

Agenda Item: President of the Board

The Board President will reconvene the Board to meet in Executive Session. If, during the course of the meeting covered by this Notice, the Board of Trustees should determine that a closed or executive meeting or session of the Board of Trustees is required, then such closed or executive meeting or session as authorized by **the Texas Open Meetings Act**, Texas Government Code **Section 551.001** et seq., will be held by the School Board at the date, hour, and place given in this Notice or as soon after the commencement of the meeting covered by this Notice as the School Board may conveniently meet in such closed or executive meeting or session concerning any and all purposes permitted by the Act, including but not limited to the following section(s) and purpose(s): Texas Government Code **Section 551.071** - Consultation with District's attorney regarding potential claim to be asserted by the District and concerning matters on which the attorney's duty to the District under the Texas Disciplinary Rules of Professional Conduct clearly conflicts with the Texas Open Meetings Laws; **Section 551.074** - for the purpose of considering the appointment, resignations, reassignment, evaluation, duties, discipline or dismissal of a public officer or employee or to hear complaints or charges against public officers or employees; **Section 551.082** school children; school district employees; disciplinary matter or complaint, and **Section 551.0821** for the purpose of considering a matter regarding a public school student where personally identifiable information about the student will necessarily be revealed by the deliberation.

Time To Executive Session: _____

Time Out of Executive Session: _____

DICKINSON INDEPENDENT SCHOOL DISTRICT

BOARD AGENDA DOCUMENT

Meeting Date: April 21, 2025

Item Title: Consider and Discuss the Appeal of the Proposed Non-Renewal of a Term Contract Employee at Barber Middle School

Agenda Item: Dr. Rebecca Brown

Background Information:

Consider and Discuss the Appeal of the Proposed Non-Renewal of a Term Contract Employee at Barber Middle School

Recommendation:

The floor is open for a motion.

Action Item: _____ Yes _____ No

Motion made by _____ **seconded by** _____ **vote** _____

DICKINSON INDEPENDENT SCHOOL DISTRICT

BOARD AGENDA DOCUMENT

Meeting Date: April 21, 2025
Item Title: Non-renewal of the term contract teacher at Kranz Junior High School
Agenda Item: Dr. Rebecca Brown

Background Information:

Consider the Superintendent's recommendation to propose the non-renewal of a term contract for a Teacher at KJHS.

Policy DFBB (Local) provides the following as reason to nonrenew an employee's term contract:

- (3) *Incompetency or inefficiency in the performance of duties;*
- (6) *Failure to comply with Board policies or administrative regulations;*

Recommendation:

The Administration is recommending that the Board *propose the nonrenewal of the term contract of a KJHS teacher, due to reasons set forth within DFBB (Local) and authorize the Superintendent to provide the employee with notice of the same.*

Action Item: _____ **Yes** _____ **No**

Motion made by _____ **seconded by** _____ **vote** _____

DICKINSON INDEPENDENT SCHOOL DISTRICT

BOARD AGENDA DOCUMENT

Meeting Date: April 21, 2025

Item Title: Termination of the probationary contract of a teacher at McAdams Junior High School

Agenda Item: Dr. Rebecca Brown

Background Information:

Consider, discuss, and potentially take action on the administration's proposal to terminate the probationary contracts of a teacher at McAdams Junior High School.

Policy DFBB (Local) provides the following as reason to nonrenew an employee's term contract:

(34) Any reason constituting good cause for terminating the contract during its term.

Recommendation:

The Administration is recommending that the Board propose the termination of the probationary contract of a MJHS teacher, due to reasons set forth within DFBB (Local) and authorize the Superintendent to provide the employee with notice of the same.

Action Item: _____ **Yes** _____ **No**

Motion made by _____ **seconded by** _____ **vote** _____

DICKINSON INDEPENDENT SCHOOL DISTRICT

BOARD AGENDA DOCUMENT

Meeting Date: April 21, 2025

Item Title: Termination of the probationary contract of a teacher at McAdams Junior High School

Agenda Item: Dr. Rebecca Brown

Background Information:

Consider, discuss, and potentially take action on the administration's proposal to terminate the probationary contracts of a teacher at McAdams Junior High School.

Policy DFBB (Local) provides the following as reason to nonrenew an employee's term contract:

(34) Any reason constituting good cause for terminating the contract during its term.

Recommendation:

The Administration is recommending that the Board propose the termination of the probationary contract of a MJHS teacher, due to reasons set forth within DFBB (Local) and authorize the Superintendent to provide the employee with notice of the same.

Action Item: _____ **Yes** _____ **No**

Motion made by _____ **seconded by** _____ **vote** _____

**DICKINSON INDEPENDENT SCHOOL DISTRICT
BOARD AGENDA DOCUMENT**

Meeting Date: April 21, 2025

Item Title: Front Entry Security Camera Project

Agenda Item: Robert Cobb

Background Information:

DISD has the opportunity to greatly improve security on our campuses by updating our exterior entry cameras. DataVox has provided a turnkey, scope of work project to upgrade and replace security cameras on all DISD cameras. The Board of Trustees must approve prior to purchase because the cost of the project is over \$250,000. Due to current price volatility, the district will get an updated bid after we receive board approval. State Security Grant funding will pay for the entire scope of the project.

Recommendation:

The Superintendent and Assistant Superintendent for Administration recommend the board approve the security camera project and purchase.

Action Item: Yes No

Motion made by _____ **seconded by** _____ **vote** _____

Physical Security Proposal

for

Dickinson ISD

3303 Owens
Dickinson, TX 77539

Security Grant Project for Front Entry AXIS Upgrades

DVXB-22546

Revision : 0

Last Modified : 3/4/2025

Note: This proposal is valid until 4/3/2025

DataVox TXDPS License B16503

Account Manager

Thang Pham

System Design

John Liput



DataVox Texas DIR Vendor Number: 176-025-1479-000

Contract Number: DIR-CPO-4766

DataVox

6650 W. Sam Houston Pkwy S. | Houston, TX 77072 | 713-881-5300

1701 East Lamar, Suite 170 | Arlington, TX 76006 | 817-288-2700



DataVox Summary

Since 1988, thousands of businesses have counted on DataVox to be their trusted advanced technology partner. With DataVox, your organization can enjoy the convenience of working with a single company to design, implement and maintain all aspects of their technology needs. From audio visual, to data center, cloud, network technology, network cabling, phone systems and physical security solutions. Our award-winning customer service team is here to assist your organization 24 hours a day, 7 days a week.

Products and Services

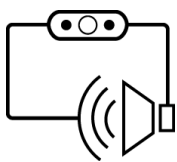

Audio Visual

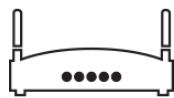

Cisco Systems



Cloud Solutions



Cyber Security



Data Center Technologies



IT Support & Managed Services



Mobility



Network Cabling

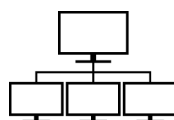

Network Technology



Phone Systems



Physical Security



Smart Building

This document is confidential and the property of DataVox. Any copy or reuse of this document, its contents, recommendations and/or solutions in whole or part is strictly prohibited without prior written consent of DataVox.

LOCATION SUMMARY

Location	Price
Lobit Elementary	\$20,383.23
Lobit Middle	\$22,484.65
Calder Road Elementary	\$11,066.75
Bay Colony Elementary	\$15,943.19
Dickinson Jr High	\$14,087.36
Hughes Road Elementary	\$11,656.76
McAdams Jr High	\$11,066.75
Dunbar Middle	\$11,329.27
Silbernagel Elementary	\$12,254.26
Dickinson High	\$17,624.58
9th Grade Center	\$14,975.83
Barber Middle	\$9,745.03
Kranz Jr High	\$37,088.82
San Leon Elementary	\$11,119.25
K. E. Little Elementary	\$11,656.76
Gator Academy	\$6,290.63
Dickinson Continuation Center	\$7,932.06
DHS Fieldhouse	\$6,066.65
Total Price (Excludes Sales Tax):	\$252,771.83

This document is confidential and the property of DataVox. Any copy or reuse of this document, its contents, recommendations and/or solutions in whole or part is strictly prohibited without prior written consent of DataVox.

SCOPE OF WORK

Lobit Elementary

DataVox to Provided and Install:

- Cameras: 7
 - o (3) P4708-PLVE Dual Sensor
 - (2) Direct to Ceiling or Wall
 - (1) DVX to Install OFE Wall mount
 - o (1) P3268-LVE 8MP Dome (Direct to Ceiling or Wall)
 - o (3) M3216-LVE – 4MP Outdoor Dome (14Watt Max POE Draw)
 - (3) New pole mounts
 - (3) OSP Patch cables
 - (3) ¾ Flex Conduit and grommets to existing enclosure
 - (3) Hose clamps for pole mount
 - o Reusing all existing CAT cable for connectivity.
 - o NOTE: This location is using an older Berk-Tex system to provide connectivity and power to pole location. Each port of the Berk-Tex system is listed only as POE (15Watt Max Draw).
- Intercom:
 - o Install a new 2N IP Verso 2.0 with a Wiegand module, a reader compatible with 125kHz and 13.56MHz frequencies, and a security module.
 - o New Intercom Cable Bundle – Cat6 and Two 18/6 cables.
 - o Note: Campus has an existing reader at the intercom location that will be replaced by new intercom. Pathway is assumed to be accessible or change order may be required

Lobit Middle

DataVox to Provided and Install:

- Cameras: 8
 - o (3) P4708-PLVE Dual Sensor
 - (1) Direct to Ceiling or Wall
 - (2) DVX to Install OFE Wall mount
 - o (1) P3268-LVE 8MP Dome (Direct to Ceiling or Wall)
 - o (3) M3216-LVE – 4MP Outdoor Dome (14Watt Max POE Draw)
 - (3) New pole mounts
 - (3) OSP Patch cables
 - (3) ¾ Flex Conduit and grommets to existing enclosure
 - (3) Hose clamps for pole mount
 - o (1) M5526-E PTZ
 - (1) New pole mounts
 - (1) OSP Patch cables
 - (1) ¾ Flex Conduit and grommets to existing enclosure
 - (1) Hose clamps for pole mount
 -
 - o Reusing all existing CAT cable for connectivity.
 - o NOTE: This location is using an older Berk-Tex system to provide connectivity and power to pole location. Each port of the Berk-Tex system is listed only as POE (15Watt Max Draw).
 - o Location will require a lift
- Intercom:
 - o Install a new 2N IP Verso 2.0 with a Wiegand module, a reader compatible with 125kHz and 13.56MHz frequencies, and a security module.
 - o New Intercom Cable Bundle – Cat6 and Two 18/6 cables.
 - o Note: Campus has an existing reader at the intercom location that will be replaced by new intercom. Pathway is assumed to be accessible or change order may be required

Calder Road Elementary

DataVox to Provided and Install:

- Cameras: 3
 - o (3) P4708-PLVE Dual Sensor
 - (2) Direct to Ceiling or Wall
 - (1) (+ DVX to Install OFE Wall mount)
 - o Reusing all existing CAT cable for connectivity.
- Intercom:
 - o Replace the existing intercom with a 2N IP Verso 2.0, including a Wiegand module, a reader compatible with 125kHz and 13.56MHz frequencies, and a security module.
 - o Run new security 18/4 cable from the S2 Panel to the intercom.
 - o Reusing all existing CAT cable for connectivity.
 - o Pathway is assumed to be accessible or change order may be required.

Bay Colony Elementary

DataVox to Provided and Install:

- Cameras: 4
 - o (2) P4708-PLVE Dual Sensor (Direct to Ceiling or Wall)
 - o (2) P3738-PLQ Quad Camera (+ DVX to Install OFE T94N01D Pendant and T91D61 Arm Mount)
 - (2) Install OFE T91A64 Corner Brackets
 - (2) ¾ Flex Conduit for Corner Mounted Camera
 - (2) Surface Mount Box
 - o Reusing all existing CAT cable for connectivity.
 - o If cable does not reach new locations where camera is to be moved, DVX will provide customer patch cable for distance.
- Intercom:
 - o Replace the existing intercom with a 2N IP Verso 2.0, including a Wiegand module, a reader compatible with 125kHz and 13.56MHz frequencies, and a security module.
 - o Run new security 18/4 cable from the S2 Panel to the intercom.
 - o Pathway is assumed to be accessible or change order may be required.

Dickinson Jr High

DataVox to Provided and Install:

- Cameras: 4
 - o (4) P4708-PLVE Dual Sensor
 - (3) Direct to Ceiling or Wall
 - (1) DVX to Install OFE Wall mount
 - o Reusing all existing CAT cable for connectivity.
- Intercom:
 - o Install a new 2N IP Verso 2.0 with a Wiegand module, a reader compatible with 125kHz and 13.56MHz frequencies, and a security module.
 - o New Intercom Cable Bundle – Cat6 and Two 18/6 cables.
 - o Note: Campus has an existing reader at the intercom location that will be replaced by new intercom. Pathway is assumed to be accessible or change order may be required.

Hughes Road Elementary

DataVox to Provided and Install:

- Cameras: 3
 - o (2) P4708-PLVE Dual Sensor (Direct to Ceiling or Wall)
 - o (1) P3738-PLQ Quad Camera (+ DVX to Install OFE T94N01D Pendant and T91D61 Arm Mount)
 - o Reusing all existing CAT cable for connectivity.
- Intercom:

This document is confidential and the property of DataVox. Any copy or reuse of this document, its contents, recommendations and/or solutions in whole or part is strictly prohibited without prior written consent of DataVox.

Security Grant Project for Front Entry AXIS Upgrades

DVXB-22546

- Replace the existing intercom with a 2N IP Verso 2.0, including a Wiegand module, a reader compatible with 125kHz and 13.56MHz frequencies, and a security module.
- Run new security 18/4 cable from the S2 Panel to the intercom.
- Reusing all existing CAT cable for connectivity.
- Pathway is assumed to be accessible or change order may be required.

McAdams Jr High

DataVox to Provided and Install:

- Cameras: 3
 - (3) P4708-PLVE Dual Sensor (Direct to Ceiling or Wall)
 - Reusing all existing CAT cable for connectivity.
- Intercom:
 - Replace the existing intercom with a 2N IP Verso 2.0, including a Wiegand module, a reader compatible with 125kHz and 13.56MHz frequencies, and a security module.
 - Run new security 18/4 cable from the S2 Panel to the intercom.
 - Reusing all existing CAT cable for connectivity.
 - Pathway is assumed to be accessible or change order may be required.

Dunbar Middle

DataVox to Provided and Install:

- Cameras: 3
 - (2) P4708-PLVE Dual Sensor (Direct to Ceiling or Wall)
 - (1) P3738-PLVE Quad Camera (Direct to Ceiling or Wall)
 - Reusing all existing CAT cable for connectivity.
- Intercom:
 - Replace the existing intercom with a 2N IP Verso 2.0, including a Wiegand module, a reader compatible with 125kHz and 13.56MHz frequencies, and a security module.
 - Run new security 18/4 cable from the S2 Panel to the intercom.
 - Reusing all existing CAT cable for connectivity.
 - Pathway is assumed to be accessible or change order may be required.

Silbernagel Elementary

DataVox to Provided and Install:

- Cameras: 3
 - (2) P4708-PLVE Dual Sensor (Direct to Ceiling or Wall)
 - (1) P3738-PLVE Quad Camera (+ DVX to Install OFE T94N01D Pendant and T91D61 Arm Mount)
 - (1) Install OFE T91A64 Corner Brackets
 - (1) 3/4 Flex Conduit for Corner Mounted Camera
 - (1) Surface Mount Box
 - Move cable to corner
 - Reusing all existing CAT cable for connectivity.
 - If cable does not reach new locations where camera is to be moved, DVX will provide customer patch cable for distance.
- Intercom:
 - Replace the existing intercom with a 2N IP Verso 2.0, including a Wiegand module, a reader compatible with 125kHz and 13.56MHz frequencies, and a security module.
 - Run new security 18/4 cable from the S2 Panel to the intercom.
 - Pathway is assumed to be accessible or change order may be required.

Dickinson High

DataVox to Provided and Install:

- Cameras: 6
 - (1) M3126-LVE Turret Camera (Direct to Ceiling or Wall).
 - (3) P4708-PLVE Dual Sensor
 - (2) Direct to Ceiling or Wall

This document is confidential and the property of DataVox. Any copy or reuse of this document, its contents, recommendations and/or solutions in whole or part is strictly prohibited without prior written consent of DataVox.

- (1) DVX to Install OFE Wall mount
 - (1) P3738-PLQ Quad Camera (Direct to Ceiling or Wall)
 - (1) P3268-LVE 8MP Dome (Direct to Ceiling or Wall)
 - Reusing all existing CAT cable for connectivity.
- Intercom:
 - Install a new 2N IP Verso 2.0 with a Wiegand module, a reader compatible with 125kHz and 13.56MHz frequencies, and a security module.
 - New Intercom Cable Bundle – Cat6 and Two 18/6 cables.
 - Note: Campus has an existing reader at the intercom location that will be replaced by new intercom. Pathway is assumed to be accessible or change order may be required.

9th Grade Center

DataVox to Provided and Install:

- Cameras: 4
 - (2) P3738-PLQ Quad Camera
 - (1) Direct to Ceiling or Wall
 - (1) DVX to Install OFE T94N01D Pendant and T91D61 Arm Mount
 - (2) P3268-LVE 8MP Dome (Direct to Ceiling or Wall)
 - Reusing all existing CAT cable for connectivity.
- Intercom:
 - Install a new 2N IP Verso 2.0 with a Wiegand module, a reader compatible with 125kHz and 13.56MHz frequencies, and a security module.
 - New Intercom Cable Bundle – Cat6 and Two 18/6 cables.
 - Note: Campus has an existing reader at the intercom location that will be replaced by new intercom. Pathway is assumed to be accessible or change order may be required.

Barber Middle

DataVox to Provided and Install:

- Cameras: 3
 - (1) P4708-PLVE Dual Sensor (+ Install OFE Wall mount).
 - (2) M3126-LVE Turret Camera (Direct to Ceiling or Wall).
 - Reusing all existing CAT cable for connectivity.
- Intercom:
 - Replace the existing intercom with a 2N IP Verso 2.0, including a Wiegand module, a reader compatible with 125kHz and 13.56MHz frequencies, and a security module.
 - Run new security 18/4 trigger cable from the S2 Panel to the intercom.
 - Reuse existing CAT and Wiegand Cable for connectivity and Reader.
 - Pathway is assumed to be available or change order may be required.
- Note: One M3126 (rotunda area) will require a 20-24ft ladder. If ladder is unavailable on-site, a lift may be required on change order.

Kranz Jr High

DataVox to Provided and Install:

- Cameras: 8
 - (2) P4708-PLVE Dual Sensor
 - (1) Direct to Ceiling or Wall
 - (1) DVX to Install OFE Wall mount
 - (1) P3268-LVE 8MP Dome (Direct to Ceiling or Wall)
 - (2) Q6318 PTZ
 - (2) New pole mounts
 - (2) OSP Patch cables
 - (2) ¾ Flex Conduit and grommets to existing enclosure
 - (2) Hose clamps for pole mount
 - (3) P3738-PLQ Quad Camera (+ DVX to Install OFE T94N01D Pendant and T91D61 Arm Mount)

This document is confidential and the property of DataVox. Any copy or reuse of this document, its contents, recommendations and/or solutions in whole or part is strictly prohibited without prior written consent of DataVox.

- (3) New pole mounts
 - (3) OSP Patch cables
 - (3) ¾ Flex Conduit and grommets to existing enclosure
 - (3) Hose clamps for pole mount
- (3) D8208 POE++ Switches (OFE Enclosure, Fiber, SPF)
- Reusing all existing CAT cable for connectivity.
- NOTE: This location is using an older Berk-Tex system to provide connectivity and power to pole location. Each port of the Berk-Tex system is listed only as POE (15Watt Max Draw).
- Location will require a lift
- Intercom:
 - Install a new 2N IP Verso 2.0 with a Wiegand module, a reader compatible with 125kHz and 13.56MHz frequencies, and a security module.
 - New Intercom Cable Bundle – Cat6 and Two 18/6 cables.
 - Note: Campus has an existing reader at the intercom location that will be replaced by new intercom. Pathway is assumed to be accessible or change order may be required

San Leon Elementary

DataVox to Provided and Install:

- Cameras: 3
 - (3) P4708-PLVE Dual Sensor (Direct to Ceiling or Wall)
 - Reusing all existing CAT cable for connectivity.
- Intercom:
 - Replace the existing intercom with a 2N IP Verso 2.0, including a Wiegand module, a reader compatible with 125kHz and 13.56MHz frequencies, and a security module.
 - Run new security 18/4 cable from the S2 Panel to the intercom.
 - Reusing all existing CAT cable for connectivity.
 - Pathway is assumed to be accessible or change order may be required.

K. E. Little Elementary

DataVox to Provided and Install:

- Cameras: 3
 - (2) P4708-PLVE Dual Sensor (Direct to Ceiling or Wall)
 - (1) P3738-PLVE Quad Camera (+ DVX to Install OFE T94N01D Pendant and T91D61 Arm Mount)
 - Reusing all existing CAT cable for connectivity.
- Intercom:
 - Replace the existing intercom with a 2N IP Verso 2.0, including a Wiegand module, a reader compatible with 125kHz and 13.56MHz frequencies, and a security module.
 - Run new security 18/4 cable from the S2 Panel to the intercom.
 - Reusing all existing CAT cable for connectivity.
 - Pathway is assumed to be accessible or change order may be required.

Gator Academy – No Drawings Provided

DataVox to Provided and Install:

- Cameras: 1
 - (1) P3268-LVE 8MP Dome (Direct to Ceiling or Wall).
 - Reusing all existing CAT cable for connectivity.
- Intercom:
 - Replace the existing intercom with a 2N IP Verso 2.0, including a Wiegand module, a reader compatible with 125kHz and 13.56MHz frequencies, and a security module.
 - Reusing all existing CAT cable and copper cable for connectivity, reader and trigger cable.
 - Pathway is assumed to be accessible or change order may be required.
 - DVX will cover any hole in brick with faceplate or silicon. No formal brick or mortars repair is included in this scope of work.

This document is confidential and the property of DataVox. Any copy or reuse of this document, its contents, recommendations and/or solutions in whole or part is strictly prohibited without prior written consent of DataVox.

Dickinson Continuation Center – No Drawings Provided

DataVox to Provide and Install:

- Cameras: 2
 - o (1) P4708-PLVE Dual Sensor (Direct to Ceiling or Wall).
 - o (1) P3268-LVE 8MP Dome (Direct to Ceiling or Wall)
 - o Reusing all existing CAT cable for connectivity.
- Intercom:
 - o Replace the existing intercom with a 2N IP Verso 2.0, including a Wiegand module, a reader compatible with 125kHz and 13.56MHz frequencies, and a security module.
 - o Reusing all existing CAT cable and copper cable for connectivity, reader and trigger cable.
 - o Pathway is assumed to be accessible or change order may be required.
 - o DVX will cover any hole in brick with faceplate or silicon. No formal brick or mortars repair is included in this scope of work.

DHS Fieldhouse – No Drawings Provided

- Intercom:
 - o Install a new 2N IP Verso 2.0 with a Wiegand module, a reader compatible with 125kHz and 13.56MHz frequencies, and a security module.
 - o New Intercom Cable Bundle – Cat6 and Two 18/6 cables.
 - o Note: Campus has an existing reader at the intercom location that will be replaced by new intercom.
 - o Pathway is assumed to be accessible or change order may be required.

BILL OF MATERIALS







Note: Installed Price Includes Equipment and Labor

Lobit Elementary	Installation Price
------------------	--------------------

Video Surveillance Software Programming

	1	DataVox	Security Programming Labor for IP'ing Units. Customer is Responsible for Enrolling and Naming all Units into Existing VMS.	
OFE	7	OFE	OFE Existing Camera License and Manufacture Software Maintenance (if Required)	
				Video Surveillance Software Programming
				\$1,230.00

Video Surveillance Cameras

	3	Axis Communications	M3216-LVE 4MP Fixed dome camera with Deep Learning Processing Unit, Forensic WDR, Lightfinder and Optimized IR	
	1	Axis Communications	T91B47 Indoor/Outdoor Pole Mount 100-410mm	
	1	Axis Communications	P3268-LVE 8MP Outdoor Varifocal Dome Camera High-performance fixed dome camera with Deep Learning Processing Unit (DLPU). Forensic WDR, Lightfinder 2.0 and Optimized IR. Discreet, dust- and IK10 vandal-resistant outdoor casing	
	3	Axis Communications	P4708-PLVE 2x8MP Dual-Sensor Camera, 30fps, 4K, 360° IR, Forensic WDR, Deep Learning DLPU, Zipstream	
	7	DataVox	Demolition of Existing IP Cameras	
	1	DataVox	Miscellaneous Hardware For Mounting Components	
OFE	1	OFE	Owner Furnished and DataVox Installed Mounting Hardware for Cameras	
OFE	7	OFE	Owner Furnished Dedicated Low Voltage Conduit Cable Pathway from Security Device Location to Nearest MDF/IDF. This includes Conduit, Coring, Boring, Connectors, Pull String, Penetrations and Junction Boxes as Required. Conduit Must be Installed Prior to DataVox Installation	
				Video Surveillance Cameras
				\$10,279.41

Intercom Software Programming

	1	DataVox	Security Programming Labor for IP'ing Units. Customer is Responsible for Enrolling and Naming all Units into Existing VMS.	
---	---	----------------	--	--

This document is confidential and the property of DataVox. Any copy or reuse of this document, its contents, recommendations and/or solutions in whole or part is strictly prohibited without prior written consent of DataVox.

OFE

- 1 **OFE**
OFE Existing Intercom/Camera License and Manufacture Software Maintenance (if Required). Also, OFE Phone System Programming and SIP Endpoint Licenses for Integration and Intercom Call Communication.

Intercom Software Programming \$410.00

Intercom Hardware

-  1 **Axis Communications**
01259-001 - 2N® IP Verso Wiegand Module
-  1 **Axis Communications**
2N® IP Verso 2M Surface Frame
-  1 **Axis Communications**
2N® IP Verso 2M Backplate
-  1 **Axis Communications**
2N® IP Security Relay
-  1 **Axis Communications**
IP Verso Bluetooth and RFID Reader, 125kHz, 13.56MHz Secured, NFC, Black
-  1 **Axis Communications**
2N IP VERSO 2.0 - Main Unit with Camera
-  1 **DataVox**
Access Control Door Field Device Testing
-  1 **DataVox**
Miscellaneous Hardware For Mounting Components

OFE

- 1 **OFE**
Owner Furnished Existing Access Controlled Door with Door Controller, Card Reader, Electrified Hardware to be Released Via Intercom.

OFE

- 1 **OFE**
Owner Furnished Dedicated Low Voltage Conduit Cable Pathway from Security Device Location to Nearest MDF/IDF. This includes Conduit, Coring, Boring, Connectors, Pull String, Penetrations and Junction Boxes as Required. Conduit Must be Installed Prior to DataVox Installation

Intercom Hardware \$3,626.22

Network Equipment

OFE

- 1 **OFE**
Owner Furnished Network Connectivity and Internet Services between Sites and Buildings

OFE

- 1 **OFE**
Owner Furnished Patch Panels, Rack Equipment, Mounting Hardware, and Cable Tray

This document is confidential and the property of DataVox. Any copy or reuse of this document, its contents, recommendations and/or solutions in whole or part is strictly prohibited without prior written consent of DataVox.

OFE 1 **OFE**
 Owner Furnished POE Network Switches for Security Devices in MDF/IDF Locations

OFE 1 **OFE**
 Owner Furnished and Installed Server and Storage with included Video Management and/or Access Control Software

Network Equipment **\$0.00**

Security Cabling

 3 **Commscope**
 Cat6 OSP Patch Cord, F/UTP, LSZH, 5ft - Black

 500 **DataVox**
 Security 18/6 Cabling

 3 **DataVox**
 Flex Conduit Mounting Hardware

 1 **DataVox**
 Man Lift - 35' - 1 Day Rental, Includes Drop Off and Pickup

 2 **DataVox**
 5' Slim Cat 6 Patch Cable - Yellow

 4 **DataVox**
 Miscellaneous Pathway Support and Cabling Material

 250 **General Cable**
 DataVox Security Cat 6 Cabling

OFE 1 **OFE**
 Owner Furnished Composite Access Control Cabling from Central IDF Closet to Existing Card Reader Door Locations

OFE 7 **OFE**
 Owner Furnished Cat5e/6/6A Cabling for Security Device Locations including Patch Cords, Patch Panels, and Rack Equipment

OFE 1 **OFE**
 Owner Furnished Nema Enclosure with Berk-Tex System for Pole Device Location. DVX will Terminate New OSP Patch Cables to Existing System for Connectivity

 1 **Panduit**
 Cat 6 Modular Jack

 1 **Panduit**
 Cat 6 2 Port Surface Mount Box

Security Cabling **\$3,505.10**

DataVox Management Services

This document is confidential and the property of DataVox. Any copy or reuse of this document, its contents, recommendations and/or solutions in whole or part is strictly prohibited without prior written consent of DataVox.

Security Grant Project for Front Entry AXIS Upgrades

DVXB-22546







	1	DataVox Solution Architect Design and Engineering Services	
	1	DataVox DIR Contract Fee	
	1	DataVox Project Management Services - Planning, Scheduling, Order Processing, Construction Meetings and Close Out Design and Engineering Services - CAD/ Visio As-Built Drawings, Product Detail Information, and Configuration Documentation Commissioning Services - Testing, Tuning, and End User Training	
		DataVox Management Services	\$1,332.50
		Total:	\$20,383.23

Lobit Middle	Installation Price
---------------------	---------------------------

Video Surveillance Software Programming

	1	DataVox Security Programming Labor for IP'ing Units. Customer is Responsible for Enrolling and Naming all Units into Existing VMS.	
OFE	8	OFE OFE Existing Camera License and Manufacture Software Maintenance (if Required)	
		Video Surveillance Software Programming	\$1,230.00



Video Surveillance Cameras

	1	Axis Communications M5526-E PTZ Camera Indoor/Outdoor PTZ Dome with Optical Zoom, Zipstream Technology, and WDR- Forensic Capture 10x Zoom and Focus Recall	
	1	Axis Communications Axis TQ5001-E Wall-and-Pole Mount - Robust Mount for PTZ Camera	
	3	Axis Communications M3216-LVE 4MP Fixed dome camera with Deep Learning Processing Unit, Forensic WDR, Lightfinder and Optimized IR	
	1	Axis Communications T91B47 Indoor/Outdoor Pole Mount 100-410mm	
	1	Axis Communications P3268-LVE 8MP Outdoor Varifocal Dome Camera High-performance fixed dome camera with Deep Learning Processing Unit (DLPU). Forensic WDR, Lightfinder 2.0 and Optimized IR. Discreet, dust- and IK10 vandal-resistant outdoor casing	
	3	Axis Communications P4708-PLVE 2x8MP Dual-Sensor Camera, 30fps, 4K, 360° IR, Forensic WDR, Deep Learning DLPU, Zipstream	

This document is confidential and the property of DataVox. Any copy or reuse of this document, its contents, recommendations and/or solutions in whole or part is strictly prohibited without prior written consent of DataVox.

Security Grant Project for Front Entry AXIS Upgrades

DVXB-22546

- 
1
Axis Communications
T91B67 Outdoor Pole Mount 65-165mm
- 
8
DataVox
Demolition of Existing IP Cameras
- 
1
DataVox
Miscellaneous Hardware For Mounting Components

OFE 2 **OFE**
 Owner Furnished and DataVox Installed Mounting Hardware for Cameras

OFE 8 **OFE**
 Owner Furnished Dedicated Low Voltage Conduit Cable Pathway from Security Device Location to Nearest MDF/IDF. This includes Conduit, Coring, Boring, Connectors, Pull String, Penetrations and Junction Boxes as Required. Conduit Must be Installed Prior to DataVox Installation

Video Surveillance Cameras **\$12,153.59**







Intercom Software Programming

- 
1
DataVox
Security Programming Labor for IP'ing Units. Customer is Responsible for Enrolling and Naming all Units into Existing VMS.

OFE 1 **OFE**
 OFE Existing Intercom/Camera License and Manufacture Software Maintenance (if Required). Also, OFE Phone System Programming and SIP Endpoint Licenses for Integration and Intercom Call Communication.

Intercom Software Programming **\$410.00**



Intercom Hardware

- 
1
Axis Communications
01259-001 - 2N® IP Verso Wiegand Module
- 
1
Axis Communications
2N® IP Verso 2M Surface Frame
- 
1
Axis Communications
2N® IP Verso 2M Backplate
- 
1
Axis Communications
2N® IP Security Relay
- 
1
Axis Communications
IP Verso Bluetooth and RFID Reader, 125kHz, 13.56MHz Secured, NFC, Black
- 
1
Axis Communications
2N IP VERSO 2.0 - Main Unit with Camera

This document is confidential and the property of DataVox. Any copy or reuse of this document, its contents, recommendations and/or solutions in whole or part is strictly prohibited without prior written consent of DataVox.

Security Grant Project for Front Entry AXIS Upgrades







DVXB-22546

	1	DataVox Access Control Door Field Device Testing	
	1	DataVox Miscellaneous Hardware For Mounting Components	
OFE	1	OFE Owner Furnished Existing Access Controlled Door with Door Controller, Card Reader, Electrified Hardware to be Released Via Intercom.	
OFE	1	OFE Owner Furnished Dedicated Low Voltage Conduit Cable Pathway from Security Device Location to Nearest MDF/IDF. This includes Conduit, Coring, Boring, Connectors, Pull String, Penetrations and Junction Boxes as Required. Conduit Must be Installed Prior to DataVox Installation	
			Intercom Hardware
			\$3,626.22

Network Equipment

OFE	1	OFE Owner Furnished Network Connectivity and Internet Services between Sites and Buildings	
OFE	1	OFE Owner Furnished Patch Panels, Rack Equipment, Mounting Hardware, and Cable Tray	
OFE	1	OFE Owner Furnished POE Network Switches for Security Devices in MDF/IDF Locations	
OFE	1	OFE Owner Furnished and Installed Server and Storage with included Video Management and/or Access Control Software	
			Network Equipment
			\$0.00

Security Cabling

	4	Commscope Cat6 OSP Patch Cord, F/UTP, LSZH, 5ft - Black	
	500	DataVox Security 18/6 Cabling	
	4	DataVox Flex Conduit Mounting Hardware	
	1	DataVox Man Lift - 35' - 1 Day Rental, Includes Drop Off and Pickup	
	2	DataVox 5' Slim Cat 6 Patch Cable - Yellow	
	2	DataVox Miscellaneous Pathway Support and Cabling Material	

This document is confidential and the property of DataVox. Any copy or reuse of this document, its contents, recommendations and/or solutions in whole or part is strictly prohibited without prior written consent of DataVox.

Security Grant Project for Front Entry AXIS Upgrades

DVXB-22546

 250 **General Cable**
DataVox Security Cat 6 Cabling

OFE 1 **OFE**
Owner Furnished Composite Access Control Cabling from Central IDF Closet to Existing Card Reader Door Locations

OFE 8 **OFE**
Owner Furnished Cat5e/6/6A Cabling for Security Device Locations including Patch Cords, Patch Panels, and Rack Equipment

 1 **Panduit**
Cat 6 Modular Jack

 1 **Panduit**
Cat 6 2 Port Surface Mount Box

Security Cabling **\$3,732.34**

DataVox Management Services

 1 **DataVox**
Solution Architect Design and Engineering Services

 1 **DataVox**
DIR Contract Fee

 1 **DataVox**
Project Management Services - Planning, Scheduling, Order Processing, Construction Meetings and Close Out
Design and Engineering Services - CAD/ Visio As-Built Drawings, Product Detail Information, and Configuration Documentation
Commissioning Services - Testing, Tuning, and End User Training

DataVox Management Services **\$1,332.50**

Total: **\$22,484.65**

Calder Road Elementary

Installation Price

Video Surveillance Software Programming

 1 **DataVox**
Security Programming Labor for IP'ing Units. Customer is Responsible for Enrolling and Naming all Units into Existing VMS.

OFE 3 **OFE**
OFE Existing Camera License and Manufacture Software Maintenance (if Required)

Video Surveillance Software Programming **\$615.00**

Video Surveillance Cameras

This document is confidential and the property of DataVox. Any copy or reuse of this document, its contents, recommendations and/or solutions in whole or part is strictly prohibited without prior written consent of DataVox.

Security Grant Project for Front Entry AXIS Upgrades

DVXB-22546



3 **Axis Communications**
P4708-PLVE 2x8MP Dual-Sensor Camera, 30fps, 4K, 360° IR, Forensic WDR, Deep Learning DLPU, Zipstream



3 **DataVox**
Demolition of Existing IP Cameras



1 **DataVox**
Miscellaneous Hardware For Mounting Components

OFE

1 **OFE**
Owner Furnished and DataVox Installed Mounting Hardware for Cameras

OFE

3 **OFE**
Owner Furnished Dedicated Low Voltage Conduit Cable Pathway from Security Device Location to Nearest MDF/IDF. This includes Conduit, Coring, Boring, Connectors, Pull String, Penetrations and Junction Boxes as Required. Conduit Must be Installed Prior to DataVox Installation

Video Surveillance Cameras

\$5,251.78

Intercom Software Programming



1 **DataVox**
Security Programming Labor for IP'ing Units. Customer is Responsible for Enrolling and Naming all Units into Existing VMS.

OFE

1 **OFE**
OFE Existing Intercom/Camera License and Manufacture Software Maintenance (if Required). Also, OFE Phone System Programming and SIP Endpoint Licenses for Integration and Intercom Call Communication.

Intercom Software Programming

\$410.00

Intercom Hardware



1 **Axis Communications**
01259-001 - 2N® IP Verso Wiegand Module



1 **Axis Communications**
2N® IP Verso 2M Surface Frame



1 **Axis Communications**
2N® IP Verso 2M Backplate



1 **Axis Communications**
2N® IP Security Relay



1 **Axis Communications**
IP Verso Bluetooth and RFID Reader, 125kHz, 13.56MHz Secured, NFC, Black





1 **Axis Communications**
2N IP VERSO 2.0 - Main Unit with Camera

This document is confidential and the property of DataVox. Any copy or reuse of this document, its contents, recommendations and/or solutions in whole or part is strictly prohibited without prior written consent of DataVox.

Security Grant Project for Front Entry AXIS Upgrades



DVXB-22546

	1	DataVox Access Control Door Field Device Testing	
	1	DataVox Miscellaneous Hardware For Mounting Components	
OFE	1	OFE Owner Furnished Existing Access Controlled Door with Door Controller, Card Reader, Electrified Hardware to be Released Via Intercom.	
OFE	1	OFE Owner Furnished Dedicated Low Voltage Conduit Cable Pathway from Security Device Location to Nearest MDF/IDF. This includes Conduit, Coring, Boring, Connectors, Pull String, Penetrations and Junction Boxes as Required. Conduit Must be Installed Prior to DataVox Installation	
		Intercom Hardware	\$3,626.22

Network Equipment

OFE	1	OFE Owner Furnished Network Connectivity and Internet Services between Sites and Buildings	
OFE	1	OFE Owner Furnished Patch Panels, Rack Equipment, Mounting Hardware, and Cable Tray	
OFE	1	OFE Owner Furnished POE Network Switches for Security Devices in MDF/IDF Locations	
OFE	1	OFE Owner Furnished and Installed Server and Storage with included Video Management and/or Access Control Software	
		Network Equipment	\$0.00

Security Cabling

	250	DataVox Security 18/4 Cabling	
	1	DataVox Miscellaneous Pathway Support and Cabling Material	
OFE	1	OFE Owner Furnished Composite Access Control Cabling from Central IDF Closet to Existing Card Reader Door Locations	
OFE	4	OFE Owner Furnished Cat5e/6/6A Cabling for Security Device Locations including Patch Cords, Patch Panels, and Rack Equipment	
		Security Cabling	\$446.25

DataVox Management Services

This document is confidential and the property of DataVox. Any copy or reuse of this document, its contents, recommendations and/or solutions in whole or part is strictly prohibited without prior written consent of DataVox.

Security Grant Project for Front Entry AXIS Upgrades

DVXB-22546





	1	DataVox Solution Architect Design and Engineering Services	
	1	DataVox DIR Contract Fee	
	1	DataVox Project Management Services - Planning, Scheduling, Order Processing, Construction Meetings and Close Out Design and Engineering Services - CAD/ Visio As-Built Drawings, Product Detail Information, and Configuration Documentation Commissioning Services - Testing, Tuning, and End User Training	
		DataVox Management Services	\$717.50
		Total:	\$11,066.75

Bay Colony Elementary	Installation Price
------------------------------	---------------------------

Video Surveillance Software Programming

	1	DataVox Security Programming Labor for IP'ing Units. Customer is Responsible for Enrolling and Naming all Units into Existing VMS.	
OFE	4	OFE OFE Existing Camera License and Manufacture Software Maintenance (if Required)	
		Video Surveillance Software Programming	\$820.00

Video Surveillance Cameras

	2	Axis Communications P3738-PLC 4x4K Multi-Sensor Panoramic Camera with Deep Learning, 360 Degree IR Illumination	
	2	Axis Communications P4708-PLVE 2x8MP Dual-Sensor Camera, 30fps, 4K, 360° IR, Forensic WDR, Deep Learning DLPU, Zipstream	
	4	DataVox Demolition of Existing IP Cameras	
	1	DataVox Miscellaneous Hardware For Mounting Components	
OFE	2	OFE Owner Furnished and DataVox Installed Mounting Hardware for Cameras	
OFE	4	OFE Owner Furnished Dedicated Low Voltage Conduit Cable Pathway from Security Device Location to Nearest MDF/IDF. This includes Conduit, Coring, Boring, Connectors, Pull String, Penetrations and Junction Boxes as Required. Conduit Must be Installed Prior to DataVox Installation	

This document is confidential and the property of DataVox. Any copy or reuse of this document, its contents, recommendations and/or solutions in whole or part is strictly prohibited without prior written consent of DataVox.

Video Surveillance Cameras

\$8,400.72









Intercom Software Programming

- 
1
DataVox
 Security Programming Labor for IP'ing Units. Customer is Responsible for Enrolling and Naming all Units into Existing VMS.
- OFE
1
OFE
 OFE Existing Intercom/Camera License and Manufacture Software Maintenance (if Required). Also, OFE Phone System Programming and SIP Endpoint Licenses for Integration and Intercom Call Communication.

Intercom Software Programming

\$410.00

Intercom Hardware

- 
1
Axis Communications
 01259-001 - 2N® IP Verso Wiegand Module
- 
1
Axis Communications
 2N® IP Verso 2M Surface Frame
- 
1
Axis Communications
 2N® IP Verso 2M Backplate
- 
1
Axis Communications
 2N® IP Security Relay
- 
1
Axis Communications
 IP Verso Bluetooth and RFID Reader, 125kHz, 13.56MHz Secured, NFC, Black
- 
1
Axis Communications
 2N IP VERSO 2.0 - Main Unit with Camera
- 
1
DataVox
 Access Control Door Field Device Testing
- 
1
DataVox
 Miscellaneous Hardware For Mounting Components
- OFE
1
OFE
 Owner Furnished Existing Access Controlled Door with Door Controller, Card Reader, Electrified Hardware to be Released Via Intercom.
- OFE
1
OFE
 Owner Furnished Dedicated Low Voltage Conduit Cable Pathway from Security Device Location to Nearest MDF/IDF. This includes Conduit, Coring, Boring, Connectors, Pull String, Penetrations and Junction Boxes as Required. Conduit Must be Installed Prior to DataVox Installation

Intercom Hardware

\$3,626.22





Network Equipment

This document is confidential and the property of DataVox. Any copy or reuse of this document, its contents, recommendations and/or solutions in whole or part is strictly prohibited without prior written consent of DataVox.

OFE	1	OFE Owner Furnished Network Connectivity and Internet Services between Sites and Buildings
OFE	1	OFE Owner Furnished Patch Panels, Rack Equipment, Mounting Hardware, and Cable Tray
OFE	1	OFE Owner Furnished POE Network Switches for Security Devices in MDF/IDF Locations
OFE	1	OFE Owner Furnished and Installed Server and Storage with included Video Management and/or Access Control Software



Network Equipment	\$0.00
--------------------------	---------------

Security Cabling

	250	DataVox Security 18/4 Cabling
	2	DataVox Flex Conduit Mounting Hardware
	2	DataVox DataVox Labor for Relocation of Existing CAT Cable. DataVox Assumes Slack in Existing Cable Run for Move. Or Change Order will be Required.
	3	DataVox Miscellaneous Pathway Support and Cabling Material
OFE	1	OFE Owner Furnished Composite Access Control Cabling from Central IDF Closet to Existing Card Reader Door Locations
OFE	5	OFE Owner Furnished Cat5e/6/6A Cabling for Security Device Locations including Patch Cords, Patch Panels, and Rack Equipment

Security Cabling	\$1,968.75
-------------------------	-------------------

DataVox Management Services

	1	DataVox Solution Architect Design and Engineering Services
	1	DataVox DIR Contract Fee
	1	DataVox Project Management Services - Planning, Scheduling, Order Processing, Construction Meetings and Close Out Design and Engineering Services - CAD/ Visio As-Built Drawings, Product Detail Information, and Configuration Documentation Commissioning Services - Testing, Tuning, and End User Training

This document is confidential and the property of DataVox. Any copy or reuse of this document, its contents, recommendations and/or solutions in whole or part is strictly prohibited without prior written consent of DataVox.

DataVox Management Services **\$717.50**

Total: **\$15,943.19**

Dickinson Jr High

Installation Price

Video Surveillance Software Programming

 1 **DataVox**
Security Programming Labor for IP'ing Units. Customer is Responsible for Enrolling and Naming all Units into Existing VMS.

OFE 4 **OFE**
OFE Existing Camera License and Manufacture Software Maintenance (if Required)

Video Surveillance Software Programming **\$820.00**

Video Surveillance Cameras

 4 **Axis Communications**
P4708-PLVE 2x8MP Dual-Sensor Camera, 30fps, 4K, 360° IR, Forensic WDR, Deep Learning DLPU, Zipstream

 4 **DataVox**
Demolition of Existing IP Cameras

 1 **DataVox**
Miscellaneous Hardware For Mounting Components

OFE 1 **OFE**
Owner Furnished and DataVox Installed Mounting Hardware for Cameras

OFE 4 **OFE**
Owner Furnished Dedicated Low Voltage Conduit Cable Pathway from Security Device Location to Nearest MDF/IDF. This includes Conduit, Coring, Boring, Connectors, Pull String, Penetrations and Junction Boxes as Required. Conduit Must be Installed Prior to DataVox Installation

Video Surveillance Cameras **\$6,893.21**

Intercom Software Programming

 1 **DataVox**
Security Programming Labor for IP'ing Units. Customer is Responsible for Enrolling and Naming all Units into Existing VMS.

OFE 1 **OFE**
OFE Existing Intercom/Camera License and Manufacture Software Maintenance (if Required). Also, OFE Phone System Programming and SIP Endpoint Licenses for Integration and Intercom Call Communication.









Intercom Software Programming **\$410.00**

Intercom Hardware

This document is confidential and the property of DataVox. Any copy or reuse of this document, its contents, recommendations and/or solutions in whole or part is strictly prohibited without prior written consent of DataVox.

Security Grant Project for Front Entry AXIS Upgrades

DVXB-22546

	1	Axis Communications 01259-001 - 2N® IP Verso Wiegand Module	
	1	Axis Communications 2N® IP Verso 2M Surface Frame	
	1	Axis Communications 2N® IP Verso 2M Backplate	
	1	Axis Communications 2N® IP Security Relay	
	1	Axis Communications IP Verso Bluetooth and RFID Reader, 125kHz, 13.56MHz Secured, NFC, Black	
	1	Axis Communications 2N IP VERSO 2.0 - Main Unit with Camera	
	1	DataVox Access Control Door Field Device Testing	
	1	DataVox Miscellaneous Hardware For Mounting Components	
OFE	1	OFE Owner Furnished Existing Access Controlled Door with Door Controller, Card Reader, Electrified Hardware to be Released Via Intercom.	
OFE	1	OFE Owner Furnished Dedicated Low Voltage Conduit Cable Pathway from Security Device Location to Nearest MDF/IDF. This includes Conduit, Coring, Boring, Connectors, Pull String, Penetrations and Junction Boxes as Required. Conduit Must be Installed Prior to DataVox Installation	
			Intercom Hardware
			\$3,626.22







Network Equipment			
OFE	1	OFE Owner Furnished Network Connectivity and Internet Services between Sites and Buildings	
OFE	1	OFE Owner Furnished Patch Panels, Rack Equipment, Mounting Hardware, and Cable Tray	
OFE	1	OFE Owner Furnished POE Network Switches for Security Devices in MDF/IDF Locations	
OFE	1	OFE Owner Furnished and Installed Server and Storage with included Video Management and/or Access Control Software	
			Network Equipment
			\$0.00

Security Cabling



This document is confidential and the property of DataVox. Any copy or reuse of this document, its contents, recommendations and/or solutions in whole or part is strictly prohibited without prior written consent of DataVox.

Security Grant Project for Front Entry AXIS Upgrades

DVXB-22546

	500	DataVox Security 18/6 Cabling	
	2	DataVox 5' Slim Cat 6 Patch Cable - Yellow	
	2	DataVox Miscellaneous Pathway Support and Cabling Material	
	250	General Cable DataVox Security Cat 6 Cabling	
OFE	1	OFE Owner Furnished Composite Access Control Cabling from Central IDF Closet to Existing Card Reader Door Locations	
OFE	4	OFE Owner Furnished Cat5e/6/6A Cabling for Security Device Locations including Patch Cords, Patch Panels, and Rack Equipment	
	1	Panduit Cat 6 Modular Jack	
	1	Panduit Cat 6 2 Port Surface Mount Box	
		Security Cabling	\$1,517.93

DataVox Management Services

	1	DataVox Solution Architect Design and Engineering Services	
	1	DataVox DIR Contract Fee	
	1	DataVox Project Management Services - Planning, Scheduling, Order Processing, Construction Meetings and Close Out Design and Engineering Services - CAD/ Visio As-Built Drawings, Product Detail Information, and Configuration Documentation Commissioning Services - Testing, Tuning, and End User Training	
		DataVox Management Services	\$820.00

Total:	\$14,087.36
---------------	--------------------

Hughes Road Elementary **Installation Price**

Video Surveillance Software Programming





	1	DataVox Security Programming Labor for IP'ing Units. Customer is Responsible for Enrolling and Naming all Units into Existing VMS.	
---	---	--	--

This document is confidential and the property of DataVox. Any copy or reuse of this document, its contents, recommendations and/or solutions in whole or part is strictly prohibited without prior written consent of DataVox.

OFE 3 **OFE**
 OFE Existing Camera License and Manufacture Software Maintenance (if Required)

Video Surveillance Software Programming **\$615.00**

Video Surveillance Cameras

-  1 **Axis Communications**
 P3738-PLE 4x4K Multi-Sensor Panoramic Camera with Deep Learning, 360 Degree IR Illumination
-  2 **Axis Communications**
 P4708-PLVE 2x8MP Dual-Sensor Camera, 30fps, 4K, 360° IR, Forensic WDR, Deep Learning DLPU, Zipstream
-  3 **DataVox**
 Demolition of Existing IP Cameras
-  1 **DataVox**
 Miscellaneous Hardware For Mounting Components
- OFE** 1 **OFE**
 Owner Furnished and DataVox Installed Mounting Hardware for Cameras
- OFE** 3 **OFE**
 Owner Furnished Dedicated Low Voltage Conduit Cable Pathway from Security Device Location to Nearest MDF/IDF. This includes Conduit, Coring, Boring, Connectors, Pull String, Penetrations and Junction Boxes as Required. Conduit Must be Installed Prior to DataVox Installation



Video Surveillance Cameras **\$5,841.79**

Intercom Software Programming

-  1 **DataVox**
 Security Programming Labor for IP'ing Units. Customer is Responsible for Enrolling and Naming all Units into Existing VMS.
- OFE** 1 **OFE**
 OFE Existing Intercom/Camera License and Manufacture Software Maintenance (if Required). Also, OFE Phone System Programming and SIP Endpoint Licenses for Integration and Intercom Call Communication.

Intercom Software Programming **\$410.00**





Intercom Hardware

-  1 **Axis Communications**
 01259-001 - 2N® IP Verso Wiegand Module
-  1 **Axis Communications**
 2N® IP Verso 2M Surface Frame
-  1 **Axis Communications**
 2N® IP Verso 2M Backplate

This document is confidential and the property of DataVox. Any copy or reuse of this document, its contents, recommendations and/or solutions in whole or part is strictly prohibited without prior written consent of DataVox.

Security Grant Project for Front Entry AXIS Upgrades

DVXB-22546

	1	Axis Communications 2N® IP Security Relay
	1	Axis Communications IP Verso Bluetooth and RFID Reader, 125kHz, 13.56MHz Secured, NFC, Black
	1	Axis Communications 2N IP VERSO 2.0 - Main Unit with Camera
	1	DataVox Access Control Door Field Device Testing
	1	DataVox Miscellaneous Hardware For Mounting Components
OFE	1	OFE Owner Furnished Existing Access Controlled Door with Door Controller, Card Reader, Electrified Hardware to be Released Via Intercom.
OFE	1	OFE Owner Furnished Dedicated Low Voltage Conduit Cable Pathway from Security Device Location to Nearest MDF/IDF. This includes Conduit, Coring, Boring, Connectors, Pull String, Penetrations and Junction Boxes as Required. Conduit Must be Installed Prior to DataVox Installation

Intercom Hardware \$3,626.22

Network Equipment

OFE	1	OFE Owner Furnished Network Connectivity and Internet Services between Sites and Buildings
OFE	1	OFE Owner Furnished Patch Panels, Rack Equipment, Mounting Hardware, and Cable Tray
OFE	1	OFE Owner Furnished POE Network Switches for Security Devices in MDF/IDF Locations
OFE	1	OFE Owner Furnished and Installed Server and Storage with included Video Management and/or Access Control Software

Network Equipment \$0.00

Security Cabling

	250	DataVox Security 18/4 Cabling
	1	DataVox Miscellaneous Pathway Support and Cabling Material

This document is confidential and the property of DataVox. Any copy or reuse of this document, its contents, recommendations and/or solutions in whole or part is strictly prohibited without prior written consent of DataVox.

Security Grant Project for Front Entry AXIS Upgrades

DVXB-22546

OFE 1 **OFE**
 Owner Furnished Composite Access Control Cabling from Central IDF Closet to Existing Card Reader Door Locations

OFE 4 **OFE**
 Owner Furnished Cat5e/6/6A Cabling for Security Device Locations including Patch Cords, Patch Panels, and Rack Equipment

Security Cabling **\$446.25**

DataVox Management Services

 1 **DataVox**
 Solution Architect Design and Engineering Services

 1 **DataVox**
 DIR Contract Fee

 1 **DataVox**
 Project Management Services - Planning, Scheduling, Order Processing, Construction Meetings and Close Out
 Design and Engineering Services - CAD/ Visio As-Built Drawings, Product Detail Information, and Configuration Documentation
 Commissioning Services - Testing, Tuning, and End User Training

DataVox Management Services **\$717.50**

Total: **\$11,656.76**

McAdams Jr High

Installation Price

Video Surveillance Software Programming

 1 **DataVox**
 Security Programming Labor for IP'ing Units. Customer is Responsible for Enrolling and Naming all Units into Existing VMS.

OFE 3 **OFE**
 OFE Existing Camera License and Manufacture Software Maintenance (if Required)

Video Surveillance Software Programming **\$615.00**

Video Surveillance Cameras

 3 **Axis Communications**
 P4708-PLVE 2x8MP Dual-Sensor Camera, 30fps, 4K, 360° IR, Forensic WDR, Deep Learning DLPU, Zipstream

 3 **DataVox**
 Demolition of Existing IP Cameras

 1 **DataVox**
 Miscellaneous Hardware For Mounting Components

This document is confidential and the property of DataVox. Any copy or reuse of this document, its contents, recommendations and/or solutions in whole or part is strictly prohibited without prior written consent of DataVox.

OFE 1 **OFE**
Owner Furnished and DataVox Installed Mounting Hardware for Cameras

OFE 3 **OFE**
Owner Furnished Dedicated Low Voltage Conduit Cable Pathway from Security Device Location to Nearest MDF/IDF. This includes Conduit, Coring, Boring, Connectors, Pull String, Penetrations and Junction Boxes as Required. Conduit Must be Installed Prior to DataVox Installation

Video Surveillance Cameras **\$5,251.78**

Intercom Software Programming

 1 **DataVox**
Security Programming Labor for IP'ing Units. Customer is Responsible for Enrolling and Naming all Units into Existing VMS.

OFE 1 **OFE**
OFE Existing Intercom/Camera License and Manufacture Software Maintenance (if Required). Also, OFE Phone System Programming and SIP Endpoint Licenses for Integration and Intercom Call Communication.

Intercom Software Programming **\$410.00**

Intercom Hardware

 1 **Axis Communications**
01259-001 - 2N® IP Verso Wiegand Module

 1 **Axis Communications**
2N® IP Verso 2M Surface Frame

 1 **Axis Communications**
2N® IP Verso 2M Backplate

 1 **Axis Communications**
2N® IP Security Relay

 1 **Axis Communications**
IP Verso Bluetooth and RFID Reader, 125kHz, 13.56MHz Secured, NFC, Black

 1 **Axis Communications**
2N IP VERSO 2.0 - Main Unit with Camera

 1 **DataVox**
Access Control Door Field Device Testing

 1 **DataVox**
Miscellaneous Hardware For Mounting Components

OFE 1 **OFE**
Owner Furnished Existing Access Controlled Door with Door Controller, Card Reader, Electrified Hardware to be Released Via Intercom.



This document is confidential and the property of DataVox. Any copy or reuse of this document, its contents, recommendations and/or solutions in whole or part is strictly prohibited without prior written consent of DataVox.

OFE	1	OFE Owner Furnished Dedicated Low Voltage Conduit Cable Pathway from Security Device Location to Nearest MDF/IDF. This includes Conduit, Coring, Boring, Connectors, Pull String, Penetrations and Junction Boxes as Required. Conduit Must be Installed Prior to DataVox Installation	Intercom Hardware	\$3,626.22
------------	---	--	--------------------------	-------------------



Network Equipment

OFE	1	OFE Owner Furnished Network Connectivity and Internet Services between Sites and Buildings		
OFE	1	OFE Owner Furnished Patch Panels, Rack Equipment, Mounting Hardware, and Cable Tray		
OFE	1	OFE Owner Furnished POE Network Switches for Security Devices in MDF/IDF Locations		
OFE	1	OFE Owner Furnished and Installed Server and Storage with included Video Management and/or Access Control Software		
			Network Equipment	\$0.00

Security Cabling

	250	DataVox Security 18/4 Cabling		
	1	DataVox Miscellaneous Pathway Support and Cabling Material		
OFE	1	OFE Owner Furnished Composite Access Control Cabling from Central IDF Closet to Existing Card Reader Door Locations		
OFE	4	OFE Owner Furnished Cat5e/6/6A Cabling for Security Device Locations including Patch Cords, Patch Panels, and Rack Equipment		
			Security Cabling	\$446.25

DataVox Management Services

	1	DataVox Solution Architect Design and Engineering Services		
	1	DataVox DIR Contract Fee		

This document is confidential and the property of DataVox. Any copy or reuse of this document, its contents, recommendations and/or solutions in whole or part is strictly prohibited without prior written consent of DataVox.





	<p>1 DataVox Project Management Services - Planning, Scheduling, Order Processing, Construction Meetings and Close Out Design and Engineering Services - CAD/ Visio As-Built Drawings, Product Detail Information, and Configuration Documentation Commissioning Services - Testing, Tuning, and End User Training</p>	<p>DataVox Management Services \$717.50</p>
		<p>Total: \$11,066.75</p>

Dunbar Middle	Installation Price
----------------------	---------------------------

Video Surveillance Software Programming

	<p>1 DataVox Security Programming Labor for IP'ing Units. Customer is Responsible for Enrolling and Naming all Units into Existing VMS.</p>	
OFE	<p>3 OFE OFE Existing Camera License and Manufacture Software Maintenance (if Required)</p>	
		<p>Video Surveillance Software Programming \$615.00</p>

Video Surveillance Cameras

	<p>1 Axis Communications P3738-PLV 4x4K Multi-Sensor Panoramic Camera with Deep Learning, 360 Degree IR Illumination</p>	
	<p>2 Axis Communications P4708-PLVE 2x8MP Dual-Sensor Camera, 30fps, 4K, 360° IR, Forensic WDR, Deep Learning DLPU, Zipstream</p>	
	<p>3 DataVox Demolition of Existing IP Cameras</p>	
	<p>1 DataVox Miscellaneous Hardware For Mounting Components</p>	
OFE	<p>3 OFE Owner Furnished Dedicated Low Voltage Conduit Cable Pathway from Security Device Location to Nearest MDF/IDF. This includes Conduit, Coring, Boring, Connectors, Pull String, Penetrations and Junction Boxes as Required. Conduit Must be Installed Prior to DataVox Installation</p>	
		<p>Video Surveillance Cameras \$5,514.30</p>

Intercom Software Programming

	<p>1 DataVox Security Programming Labor for IP'ing Units. Customer is Responsible for Enrolling and Naming all Units into Existing VMS.</p>	
---	---	--

This document is confidential and the property of DataVox. Any copy or reuse of this document, its contents, recommendations and/or solutions in whole or part is strictly prohibited without prior written consent of DataVox.

OFE 1 **OFE**
 OFE Existing Intercom/Camera License and Manufacture Software Maintenance (if Required). Also, OFE Phone System Programming and SIP Endpoint Licenses for Integration and Intercom Call Communication.

Intercom Software Programming **\$410.00**

Intercom Hardware

- 

1 **Axis Communications**
 01259-001 - 2N® IP Verso Wiegand Module
- 

1 **Axis Communications**
 2N® IP Verso 2M Surface Frame
- 

1 **Axis Communications**
 2N® IP Verso 2M Backplate
- 

1 **Axis Communications**
 2N® IP Security Relay
- 

1 **Axis Communications**
 IP Verso Bluetooth and RFID Reader, 125kHz, 13.56MHz Secured, NFC, Black
- 

1 **Axis Communications**
 2N IP VERSO 2.0 - Main Unit with Camera
- 

1 **DataVox**
 Access Control Door Field Device Testing
- 

1 **DataVox**
 Miscellaneous Hardware For Mounting Components

OFE 1 **OFE**
 Owner Furnished Existing Access Controlled Door with Door Controller, Card Reader, Electrified Hardware to be Released Via Intercom.

OFE 1 **OFE**
 Owner Furnished Dedicated Low Voltage Conduit Cable Pathway from Security Device Location to Nearest MDF/IDF. This includes Conduit, Coring, Boring, Connectors, Pull String, Penetrations and Junction Boxes as Required. Conduit Must be Installed Prior to DataVox Installation

Intercom Hardware **\$3,626.22**

Network Equipment

OFE 1 **OFE**
 Owner Furnished Network Connectivity and Internet Services between Sites and Buildings

OFE 1 **OFE**
 Owner Furnished Patch Panels, Rack Equipment, Mounting Hardware, and Cable Tray

This document is confidential and the property of DataVox. Any copy or reuse of this document, its contents, recommendations and/or solutions in whole or part is strictly prohibited without prior written consent of DataVox.

OFE 1 **OFE**
Owner Furnished POE Network Switches for Security Devices in MDF/IDF Locations

OFE 1 **OFE**
Owner Furnished and Installed Server and Storage with included Video Management and/or Access Control Software

Network Equipment **\$0.00**

Security Cabling

 250 **DataVox**
Security 18/4 Cabling

 1 **DataVox**
Miscellaneous Pathway Support and Cabling Material

OFE 1 **OFE**
Owner Furnished Composite Access Control Cabling from Central IDF Closet to Existing Card Reader Door Locations

OFE 4 **OFE**
Owner Furnished Cat5e/6/6A Cabling for Security Device Locations including Patch Cords, Patch Panels, and Rack Equipment

Security Cabling **\$446.25**

DataVox Management Services

 1 **DataVox**
Solution Architect Design and Engineering Services

 1 **DataVox**
DIR Contract Fee

 1 **DataVox**
Project Management Services - Planning, Scheduling, Order Processing, Construction Meetings and Close Out
Design and Engineering Services - CAD/ Visio As-Built Drawings, Product Detail Information, and Configuration Documentation
Commissioning Services - Testing, Tuning, and End User Training

DataVox Management Services **\$717.50**

Total: **\$11,329.27**

Silbernagel Elementary

Installation Price

Video Surveillance Software Programming





 1 **DataVox**
Security Programming Labor for IP'ing Units. Customer is Responsible for Enrolling and Naming all Units into Existing VMS.

This document is confidential and the property of DataVox. Any copy or reuse of this document, its contents, recommendations and/or solutions in whole or part is strictly prohibited without prior written consent of DataVox.

OFE 3 **OFE**
 OFE Existing Camera License and Manufacture Software Maintenance (if Required)

Video Surveillance Software Programming **\$615.00**

Video Surveillance Cameras

-  1 **Axis Communications**
 P3738-PLE 4x4K Multi-Sensor Panoramic Camera with Deep Learning, 360 Degree IR Illumination
-  2 **Axis Communications**
 P4708-PLVE 2x8MP Dual-Sensor Camera, 30fps, 4K, 360° IR, Forensic WDR, Deep Learning DLPU, Zipstream
-  3 **DataVox**
 Demolition of Existing IP Cameras
-  1 **DataVox**
 Miscellaneous Hardware For Mounting Components
- OFE** 1 **OFE**
 Owner Furnished and DataVox Installed Mounting Hardware for Cameras
- OFE** 3 **OFE**
 Owner Furnished Dedicated Low Voltage Conduit Cable Pathway from Security Device Location to Nearest MDF/IDF. This includes Conduit, Coring, Boring, Connectors, Pull String, Penetrations and Junction Boxes as Required. Conduit Must be Installed Prior to DataVox Installation



Video Surveillance Cameras **\$5,841.79**

Intercom Software Programming

-  1 **DataVox**
 Security Programming Labor for IP'ing Units. Customer is Responsible for Enrolling and Naming all Units into Existing VMS.
- OFE** 1 **OFE**
 OFE Existing Intercom/Camera License and Manufacture Software Maintenance (if Required). Also, OFE Phone System Programming and SIP Endpoint Licenses for Integration and Intercom Call Communication.

Intercom Software Programming **\$410.00**





Intercom Hardware

-  1 **Axis Communications**
 01259-001 - 2N® IP Verso Wiegand Module
-  1 **Axis Communications**
 2N® IP Verso 2M Surface Frame
-  1 **Axis Communications**
 2N® IP Verso 2M Backplate

This document is confidential and the property of DataVox. Any copy or reuse of this document, its contents, recommendations and/or solutions in whole or part is strictly prohibited without prior written consent of DataVox.

Security Grant Project for Front Entry AXIS Upgrades

DVXB-22546

	1	Axis Communications 2N® IP Security Relay
	1	Axis Communications IP Verso Bluetooth and RFID Reader, 125kHz, 13.56MHz Secured, NFC, Black
	1	Axis Communications 2N IP VERSO 2.0 - Main Unit with Camera
	1	DataVox Access Control Door Field Device Testing
	1	DataVox Miscellaneous Hardware For Mounting Components
OFE	1	OFE Owner Furnished Existing Access Controlled Door with Door Controller, Card Reader, Electrified Hardware to be Released Via Intercom.
OFE	1	OFE Owner Furnished Dedicated Low Voltage Conduit Cable Pathway from Security Device Location to Nearest MDF/IDF. This includes Conduit, Coring, Boring, Connectors, Pull String, Penetrations and Junction Boxes as Required. Conduit Must be Installed Prior to DataVox Installation



Intercom Hardware \$3,626.22

Network Equipment

OFE	1	OFE Owner Furnished Network Connectivity and Internet Services between Sites and Buildings
OFE	1	OFE Owner Furnished Patch Panels, Rack Equipment, Mounting Hardware, and Cable Tray
OFE	1	OFE Owner Furnished POE Network Switches for Security Devices in MDF/IDF Locations
OFE	1	OFE Owner Furnished and Installed Server and Storage with included Video Management and/or Access Control Software

Network Equipment \$0.00

Security Cabling

	250	DataVox Security 18/4 Cabling
	2	DataVox Flex Conduit Mounting Hardware
	1	DataVox Miscellaneous Pathway Support and Cabling Material

This document is confidential and the property of DataVox. Any copy or reuse of this document, its contents, recommendations and/or solutions in whole or part is strictly prohibited without prior written consent of DataVox.

Security Grant Project for Front Entry AXIS Upgrades

DVXB-22546

OFE 1 **OFE**
 Owner Furnished Composite Access Control Cabling from Central IDF Closet to Existing Card Reader Door Locations

OFE 4 **OFE**
 Owner Furnished Cat5e/6/6A Cabling for Security Device Locations including Patch Cords, Patch Panels, and Rack Equipment

Security Cabling **\$1,043.75**

DataVox Management Services

 1 **DataVox**
 Solution Architect Design and Engineering Services

 1 **DataVox**
 DIR Contract Fee

 1 **DataVox**
 Project Management Services - Planning, Scheduling, Order Processing, Construction Meetings and Close Out
 Design and Engineering Services - CAD/ Visio As-Built Drawings, Product Detail Information, and Configuration Documentation
 Commissioning Services - Testing, Tuning, and End User Training

DataVox Management Services **\$717.50**

Total: **\$12,254.26**

Dickinson High

Installation Price

Video Surveillance Software Programming

 1 **DataVox**
 Security Programming Labor for IP'ing Units. Customer is Responsible for Enrolling and Naming all Units into Existing VMS.

OFE 6 **OFE**
 OFE Existing Camera License and Manufacture Software Maintenance (if Required)

Video Surveillance Software Programming **\$1,230.00**

Video Surveillance Cameras

 1 **Axis Communications**
 M3126-LVE Dome Camera - AI-powered 4 MP turret style camera

 1 **Axis Communications**
 P3268-LVE 8MP Outdoor Varifocal Dome Camera High-performance fixed dome camera with Deep Learning Processing Unit (DLPU). Forensic WDR, Lightfinder 2.0 and Optimized IR. Discreet, dust- and IK10 vandal-resistant outdoor casing

 1 **Axis Communications**
 P3738-PLE 4x4K Multi-Sensor Panoramic Camera with Deep Learning, 360 Degree IR Illumination

This document is confidential and the property of DataVox. Any copy or reuse of this document, its contents, recommendations and/or solutions in whole or part is strictly prohibited without prior written consent of DataVox.

Security Grant Project for Front Entry AXIS Upgrades

DVXB-22546



3 **Axis Communications**
P4708-PLVE 2x8MP Dual-Sensor Camera, 30fps, 4K, 360° IR, Forensic WDR, Deep Learning DLPU, Zipstream



6 **DataVox**
Demolition of Existing IP Cameras



1 **DataVox**
Miscellaneous Hardware For Mounting Components

OFE

2 **OFE**
Owner Furnished and DataVox Installed Mounting Hardware for Cameras

OFE

6 **OFE**
Owner Furnished Dedicated Low Voltage Conduit Cable Pathway from Security Device Location to Nearest MDF/IDF. This includes Conduit, Coring, Boring, Connectors, Pull String, Penetrations and Junction Boxes as Required. Conduit Must be Installed Prior to DataVox Installation

Video Surveillance Cameras **\$9,815.43**

Intercom Software Programming



1 **DataVox**
Security Programming Labor for IP'ing Units. Customer is Responsible for Enrolling and Naming all Units into Existing VMS.

OFE

1 **OFE**
OFE Existing Intercom/Camera License and Manufacture Software Maintenance (if Required). Also, OFE Phone System Programming and SIP Endpoint Licenses for Integration and Intercom Call Communication.

Intercom Software Programming **\$410.00**

Intercom Hardware



1 **Axis Communications**
01259-001 - 2N® IP Verso Wiegand Module



1 **Axis Communications**
2N® IP Verso 2M Surface Frame



1 **Axis Communications**
2N® IP Verso 2M Backplate



1 **Axis Communications**
2N® IP Security Relay



1 **Axis Communications**
IP Verso Bluetooth and RFID Reader, 125kHz, 13.56MHz Secured, NFC, Black





1 **Axis Communications**
2N IP VERSO 2.0 - Main Unit with Camera

This document is confidential and the property of DataVox. Any copy or reuse of this document, its contents, recommendations and/or solutions in whole or part is strictly prohibited without prior written consent of DataVox.

Security Grant Project for Front Entry AXIS Upgrades





DVXB-22546

	1	DataVox Access Control Door Field Device Testing	
	1	DataVox Miscellaneous Hardware For Mounting Components	
OFE	1	OFE Owner Furnished Existing Access Controlled Door with Door Controller, Card Reader, Electrified Hardware to be Released Via Intercom.	
OFE	1	OFE Owner Furnished Dedicated Low Voltage Conduit Cable Pathway from Security Device Location to Nearest MDF/IDF. This includes Conduit, Coring, Boring, Connectors, Pull String, Penetrations and Junction Boxes as Required. Conduit Must be Installed Prior to DataVox Installation	
			Intercom Hardware
			\$3,626.22

Network Equipment

OFE	1	OFE Owner Furnished Network Connectivity and Internet Services between Sites and Buildings	
OFE	1	OFE Owner Furnished Patch Panels, Rack Equipment, Mounting Hardware, and Cable Tray	
OFE	1	OFE Owner Furnished POE Network Switches for Security Devices in MDF/IDF Locations	
OFE	1	OFE Owner Furnished and Installed Server and Storage with included Video Management and/or Access Control Software	
			Network Equipment
			\$0.00

Security Cabling

	500	DataVox Security 18/6 Cabling	
	2	DataVox 5' Slim Cat 6 Patch Cable - Yellow	
	2	DataVox Miscellaneous Pathway Support and Cabling Material	
	250	General Cable DataVox Security Cat 6 Cabling	
OFE	1	OFE Owner Furnished Composite Access Control Cabling from Central IDF Closet to Existing Card Reader Door Locations	

This document is confidential and the property of DataVox. Any copy or reuse of this document, its contents, recommendations and/or solutions in whole or part is strictly prohibited without prior written consent of DataVox.

Security Grant Project for Front Entry AXIS Upgrades

DVXB-22546

OFE

6 **OFE**
Owner Furnished Cat5e/6/6A Cabling for Security Device Locations including Patch Cords, Patch Panels, and Rack Equipment



1 **Panduit**
Cat 6 Modular Jack



1 **Panduit**
Cat 6 2 Port Surface Mount Box

Security Cabling **\$1,517.93**

DataVox Management Services



1 **DataVox**
Solution Architect Design and Engineering Services



1 **DataVox**
DIR Contract Fee



1 **DataVox**
Project Management Services - Planning, Scheduling, Order Processing, Construction Meetings and Close Out
Design and Engineering Services - CAD/ Visio As-Built Drawings, Product Detail Information, and Configuration Documentation
Commissioning Services - Testing, Tuning, and End User Training

DataVox Management Services **\$1,025.00**

Total: **\$17,624.58**

9th Grade Center

Installation Price

Video Surveillance Software Programming



1 **DataVox**
Security Programming Labor for IP'ing Units. Customer is Responsible for Enrolling and Naming all Units into Existing VMS.

OFE

4 **OFE**
OFE Existing Camera License and Manufacture Software Maintenance (if Required)

Video Surveillance Software Programming **\$820.00**

Video Surveillance Cameras



2 **Axis Communications**
P3268-LVE 8MP Outdoor Varifocal Dome Camera High-performance fixed dome camera with Deep Learning Processing Unit (DLPU). Forensic WDR, Lightfinder 2.0 and Optimized IR. Discreet, dust- and IK10 vandal-resistant outdoor casing





2 **Axis Communications**
P3738-PLP 4x4K Multi-Sensor Panoramic Camera with Deep Learning, 360 Degree IR Illumination

This document is confidential and the property of DataVox. Any copy or reuse of this document, its contents, recommendations and/or solutions in whole or part is strictly prohibited without prior written consent of DataVox.

Security Grant Project for Front Entry AXIS Upgrades

DVXB-22546

- 
4
DataVox
 Demolition of Existing IP Cameras

- 
1
DataVox
 Miscellaneous Hardware For Mounting Components

- OFE
2
OFE
 Owner Furnished and DataVox Installed Mounting Hardware for Cameras

- OFE
4
OFE
 Owner Furnished Dedicated Low Voltage Conduit Cable Pathway from Security Device Location to Nearest MDF/IDF. This includes Conduit, Coring, Boring, Connectors, Pull String, Penetrations and Junction Boxes as Required. Conduit Must be Installed Prior to DataVox Installation

Video Surveillance Cameras **\$7,781.68**

Intercom Software Programming

- 
1
DataVox
 Security Programming Labor for IP'ing Units. Customer is Responsible for Enrolling and Naming all Units into Existing VMS.

- OFE
1
OFE
 OFE Existing Intercom/Camera License and Manufacture Software Maintenance (if Required). Also, OFE Phone System Programming and SIP Endpoint Licenses for Integration and Intercom Call Communication.

Intercom Software Programming **\$410.00**

Intercom Hardware

- 
1
Axis Communications
 01259-001 - 2N® IP Verso Wiegand Module

- 
1
Axis Communications
 2N® IP Verso 2M Surface Frame

- 
1
Axis Communications
 2N® IP Verso 2M Backplate

- 
1
Axis Communications
 2N® IP Security Relay

- 
1
Axis Communications
 IP Verso Bluetooth and RFID Reader, 125kHz, 13.56MHz Secured, NFC, Black

- 
1
Axis Communications
 2N IP VERSO 2.0 - Main Unit with Camera

- 
1
DataVox
 Access Control Door Field Device Testing





This document is confidential and the property of DataVox. Any copy or reuse of this document, its contents, recommendations and/or solutions in whole or part is strictly prohibited without prior written consent of DataVox.

	1	DataVox Miscellaneous Hardware For Mounting Components	
OFE	1	OFE Owner Furnished Existing Access Controlled Door with Door Controller, Card Reader, Electrified Hardware to be Released Via Intercom.	
OFE	1	OFE Owner Furnished Dedicated Low Voltage Conduit Cable Pathway from Security Device Location to Nearest MDF/IDF. This includes Conduit, Coring, Boring, Connectors, Pull String, Penetrations and Junction Boxes as Required. Conduit Must be Installed Prior to DataVox Installation	
		Intercom Hardware	\$3,626.22

Network Equipment

OFE	1	OFE Owner Furnished Network Connectivity and Internet Services between Sites and Buildings	
OFE	1	OFE Owner Furnished Patch Panels, Rack Equipment, Mounting Hardware, and Cable Tray	
OFE	1	OFE Owner Furnished POE Network Switches for Security Devices in MDF/IDF Locations	
OFE	1	OFE Owner Furnished and Installed Server and Storage with included Video Management and/or Access Control Software	
		Network Equipment	\$0.00

Security Cabling

	500	DataVox Security 18/6 Cabling	
	2	DataVox 5' Slim Cat 6 Patch Cable - Yellow	
	2	DataVox Miscellaneous Pathway Support and Cabling Material	
	250	General Cable DataVox Security Cat 6 Cabling	
OFE	1	OFE Owner Furnished Composite Access Control Cabling from Central IDF Closet to Existing Card Reader Door Locations	
OFE	4	OFE Owner Furnished Cat5e/6/6A Cabling for Security Device Locations including Patch Cords, Patch Panels, and Rack Equipment	

This document is confidential and the property of DataVox. Any copy or reuse of this document, its contents, recommendations and/or solutions in whole or part is strictly prohibited without prior written consent of DataVox.

Security Grant Project for Front Entry AXIS Upgrades

DVXB-22546



1 **Panduit**
Cat 6 Modular Jack



1 **Panduit**
Cat 6 2 Port Surface Mount Box

Security Cabling \$1,517.93

DataVox Management Services



1 **DataVox**
Solution Architect Design and Engineering Services



1 **DataVox**
DIR Contract Fee



1 **DataVox**
Project Management Services - Planning, Scheduling, Order Processing,
Construction Meetings and Close Out
Design and Engineering Services - CAD/ Visio As-Built Drawings, Product Detail
Information, and Configuration Documentation
Commissioning Services - Testing, Tuning, and End User Training

DataVox Management Services \$820.00

Total: \$14,975.83

Barber Middle

Installation Price

Video Surveillance Software Programming



1 **DataVox**
Security Programming Labor for IP'ing Units. Customer is Responsible for
Enrolling and Naming all Units into Existing VMS.

OFE

3 **OFE**
OFE Existing Camera License and Manufacture Software Maintenance (if
Required)

Video Surveillance Software Programming \$615.00

Video Surveillance Cameras



2 **Axis Communications**
M3126-LVE Dome Camera - AI-powered 4 MP turret style camera



1 **Axis Communications**
P4708-PLVE 2x8MP Dual-Sensor Camera, 30fps, 4K, 360° IR, Forensic WDR,
Deep Learning DLPU, Zipstream



3 **DataVox**
Demolition of Existing IP Cameras



1 **DataVox**
Miscellaneous Hardware For Mounting Components

This document is confidential and the property of DataVox. Any copy or reuse of this document, its contents, recommendations and/or solutions in whole or part is strictly prohibited without prior written consent of DataVox.

 1 **DataVox**
Man Lift - 35' - 1 Day Rental, Includes Drop Off and Pickup

OFE 3 **OFE**
Owner Furnished Dedicated Low Voltage Conduit Cable Pathway from Security Device Location to Nearest MDF/IDF. This includes Conduit, Coring, Boring, Connectors, Pull String, Penetrations and Junction Boxes as Required. Conduit Must be Installed Prior to DataVox Installation

Video Surveillance Cameras **\$3,930.06**

Intercom Software Programming

 1 **DataVox**
Security Programming Labor for IP'ing Units. Customer is Responsible for Enrolling and Naming all Units into Existing VMS.

OFE 1 **OFE**
OFE Existing Intercom/Camera License and Manufacture Software Maintenance (if Required). Also, OFE Phone System Programming and SIP Endpoint Licenses for Integration and Intercom Call Communication.

Intercom Software Programming **\$410.00**

Intercom Hardware

 1 **Axis Communications**
01259-001 - 2N® IP Verso Wiegand Module

 1 **Axis Communications**
2N® IP Verso 2M Surface Frame

 1 **Axis Communications**
2N® IP Verso 2M Backplate

 1 **Axis Communications**
2N® IP Security Relay

 1 **Axis Communications**
IP Verso Bluetooth and RFID Reader, 125kHz, 13.56MHz Secured, NFC, Black

 1 **Axis Communications**
2N IP VERSO 2.0 - Main Unit with Camera

 1 **DataVox**
Access Control Door Field Device Testing

 1 **DataVox**
Miscellaneous Hardware For Mounting Components

OFE 1 **OFE**
Owner Furnished Existing Access Controlled Door with Door Controller, Card Reader, Electrified Hardware to be Released Via Intercom.



This document is confidential and the property of DataVox. Any copy or reuse of this document, its contents, recommendations and/or solutions in whole or part is strictly prohibited without prior written consent of DataVox.

OFE	1	OFE Owner Furnished Dedicated Low Voltage Conduit Cable Pathway from Security Device Location to Nearest MDF/IDF. This includes Conduit, Coring, Boring, Connectors, Pull String, Penetrations and Junction Boxes as Required. Conduit Must be Installed Prior to DataVox Installation	Intercom Hardware	\$3,626.22
------------	---	--	--------------------------	-------------------



Network Equipment

OFE	1	OFE Owner Furnished Network Connectivity and Internet Services between Sites and Buildings		
OFE	1	OFE Owner Furnished Patch Panels, Rack Equipment, Mounting Hardware, and Cable Tray		
OFE	1	OFE Owner Furnished POE Network Switches for Security Devices in MDF/IDF Locations		
OFE	1	OFE Owner Furnished and Installed Server and Storage with included Video Management and/or Access Control Software		
			Network Equipment	\$0.00

Security Cabling

	250	DataVox Security 18/4 Cabling		
	1	DataVox Miscellaneous Pathway Support and Cabling Material		
OFE	1	OFE Owner Furnished Composite Access Control Cabling from Central IDF Closet to Existing Card Reader Door Locations		
OFE	4	OFE Owner Furnished Cat5e/6/6A Cabling for Security Device Locations including Patch Cords, Patch Panels, and Rack Equipment		
			Security Cabling	\$446.25

DataVox Management Services

	1	DataVox Solution Architect Design and Engineering Services		
	1	DataVox DIR Contract Fee		

This document is confidential and the property of DataVox. Any copy or reuse of this document, its contents, recommendations and/or solutions in whole or part is strictly prohibited without prior written consent of DataVox.









	<p>1 DataVox Project Management Services - Planning, Scheduling, Order Processing, Construction Meetings and Close Out Design and Engineering Services - CAD/ Visio As-Built Drawings, Product Detail Information, and Configuration Documentation Commissioning Services - Testing, Tuning, and End User Training</p>	<p>DataVox Management Services \$717.50</p>
Total:		\$9,745.03

Kranz Jr High	Installation Price
----------------------	---------------------------

Video Surveillance Software Programming

	<p>1 DataVox Security Programming Labor for IP'ing Units. Customer is Responsible for Enrolling and Naming all Units into Existing VMS.</p>	
OFE	<p>8 OFE OFE Existing Camera License and Manufacture Software Maintenance (if Required)</p>	
Video Surveillance Software Programming		\$1,230.00

Video Surveillance Cameras

	<p>1 Axis Communications P3268-LVE 8MP Outdoor Varifocal Dome Camera High-performance fixed dome camera with Deep Learning Processing Unit (DLPU). Forensic WDR, Lightfinder 2.0 and Optimized IR. Discreet, dust- and IK10 vandal-resistant outdoor casing</p>	
	<p>3 Axis Communications P3738-PL 4x4K Multi-Sensor Panoramic Camera with Deep Learning, 360 Degree IR Illumination</p>	
	<p>2 Axis Communications P4708-PLVE 2x8MP Dual-Sensor Camera, 30fps, 4K, 360° IR, Forensic WDR, Deep Learning DLPU, Zipstream</p>	
	<p>2 Axis Communications Q6318-LE PTZ Network Camera - High-end outdoor-ready 4K UHD PTZ with quick-zoom and laser focus</p>	
	<p>1 Axis Communications T91B57 Indoor/Outdoor Aluminum Pole Mount 100-410mm</p>	
	<p>1 Axis Communications T91G61 Aluminum Wall Mount</p>	
	<p>3 Axis Communications T91B67 Outdoor Pole Mount 65-165mm</p>	
	<p>6 DataVox Demolition of Existing IP Cameras</p>	

This document is confidential and the property of DataVox. Any copy or reuse of this document, its contents, recommendations and/or solutions in whole or part is strictly prohibited without prior written consent of DataVox.

Security Grant Project for Front Entry AXIS Upgrades

DVXB-22546

 1 **DataVox**
Miscellaneous Hardware For Mounting Components

OFE 5 **OFE**
Owner Furnished and DataVox Installed Mounting Hardware for Cameras

OFE 8 **OFE**
Owner Furnished Dedicated Low Voltage Conduit Cable Pathway from Security Device Location to Nearest MDF/IDF. This includes Conduit, Coring, Boring, Connectors, Pull String, Penetrations and Junction Boxes as Required. Conduit Must be Installed Prior to DataVox Installation

Video Surveillance Cameras **\$21,150.27**

Intercom Software Programming

 1 **DataVox**
Security Programming Labor for IP'ing Units. Customer is Responsible for Enrolling and Naming all Units into Existing VMS.

OFE 1 **OFE**
OFE Existing Intercom/Camera License and Manufacture Software Maintenance (if Required). Also, OFE Phone System Programming and SIP Endpoint Licenses for Integration and Intercom Call Communication.

Intercom Software Programming **\$410.00**

Intercom Hardware

 1 **Axis Communications**
01259-001 - 2N® IP Verso Wiegand Module

 1 **Axis Communications**
2N® IP Verso 2M Surface Frame

 1 **Axis Communications**
2N® IP Verso 2M Backplate

 1 **Axis Communications**
2N® IP Security Relay

 1 **Axis Communications**
IP Verso Bluetooth and RFID Reader, 125kHz, 13.56MHz Secured, NFC, Black

 1 **Axis Communications**
2N IP VERSO 2.0 - Main Unit with Camera

 1 **DataVox**
Access Control Door Field Device Testing

 1 **DataVox**
Miscellaneous Hardware For Mounting Components

This document is confidential and the property of DataVox. Any copy or reuse of this document, its contents, recommendations and/or solutions in whole or part is strictly prohibited without prior written consent of DataVox.

OFE 1 **OFE**
 Owner Furnished Existing Access Controlled Door with Door Controller, Card Reader, Electrified Hardware to be Released Via Intercom.

OFE 1 **OFE**
 Owner Furnished Dedicated Low Voltage Conduit Cable Pathway from Security Device Location to Nearest MDF/IDF. This includes Conduit, Coring, Boring, Connectors, Pull String, Penetrations and Junction Boxes as Required. Conduit Must be Installed Prior to DataVox Installation

Intercom Hardware **\$3,626.22**

Network Equipment

 3 **Axis Communications**
 AXIS D8208-R Industrial PoE Switch is a 8-port managed industrial PoE++ Gigabit switch

 1 **Axis Communications**
 Power Supply DIN PS56 480 W (For Axis D8208-R)

OFE 3 **OFE**
 Owner Furnished Fiber Optic Cabling Including Nema Enclosure, Fiber Panels, Fiber Patch Cables, SFP Connections for Pole Device Location. DVX will Install new POE++ Switch and Power Transformer In Existing Enclosure

OFE 1 **OFE**
 Owner Furnished Network Connectivity and Internet Services between Sites and Buildings

OFE 1 **OFE**
 Owner Furnished Patch Panels, Rack Equipment, Mounting Hardware, and Cable Tray

OFE 1 **OFE**
 Owner Furnished POE Network Switches for Security Devices in MDF/IDF Locations

OFE 1 **OFE**
 Owner Furnished and Installed Server and Storage with included Video Management and/or Access Control Software

Network Equipment **\$4,919.25**

Security Cabling

 5 **Commscope**
 Cat6 OSP Patch Cord, F/UTP, LSZH, 5ft - Black

500 **DataVox**
 Security 18/6 Cabling

 5 **DataVox**
 Flex Conduit Mounting Hardware

 1 **DataVox**
 Man Lift - 35' - 1 Day Rental, Includes Drop Off and Pickup

This document is confidential and the property of DataVox. Any copy or reuse of this document, its contents, recommendations and/or solutions in whole or part is strictly prohibited without prior written consent of DataVox.

Security Grant Project for Front Entry AXIS Upgrades

DVXB-22546



2 **DataVox**
5' Slim Cat 6 Patch Cable - Yellow



2 **DataVox**
Miscellaneous Pathway Support and Cabling Material



250 **General Cable**
DataVox Security Cat 6 Cabling

OFE

1 **OFE**
Owner Furnished Composite Access Control Cabling from Central IDF Closet to Existing Card Reader Door Locations

OFE

6 **OFE**
Owner Furnished Cat5e/6/6A Cabling for Security Device Locations including Patch Cords, Patch Panels, and Rack Equipment



1 **Panduit**
Cat 6 Modular Jack



1 **Panduit**
Cat 6 2 Port Surface Mount Box

Security Cabling **\$4,010.58**

DataVox Management Services



1 **DataVox**
Solution Architect Design and Engineering Services



1 **DataVox**
DIR Contract Fee



1 **DataVox**
Project Management Services - Planning, Scheduling, Order Processing, Construction Meetings and Close Out
Design and Engineering Services - CAD/ Visio As-Built Drawings, Product Detail Information, and Configuration Documentation
Commissioning Services - Testing, Tuning, and End User Training

DataVox Management Services **\$1,742.50**

Total: **\$37,088.82**

San Leon Elementary

Installation Price

Video Surveillance Software Programming



1 **DataVox**
Security Programming Labor for IP'ing Units. Customer is Responsible for Enrolling and Naming all Units into Existing VMS.

OFE



3 **OFE**
OFE Existing Camera License and Manufacture Software Maintenance (if Required)

This document is confidential and the property of DataVox. Any copy or reuse of this document, its contents, recommendations and/or solutions in whole or part is strictly prohibited without prior written consent of DataVox.

Video Surveillance Software Programming

\$615.00

Video Surveillance Cameras

- 
3
Axis Communications
 P4708-PLVE 2x8MP Dual-Sensor Camera, 30fps, 4K, 360° IR, Forensic WDR, Deep Learning DLPU, Zipstream
- 
3
DataVox
 Demolition of Existing IP Cameras
- 
1
DataVox
 Miscellaneous Hardware For Mounting Components
- OFE
1
OFE
 Owner Furnished and DataVox Installed Mounting Hardware for Cameras
- OFE
3
OFE
 Owner Furnished Dedicated Low Voltage Conduit Cable Pathway from Security Device Location to Nearest MDF/IDF. This includes Conduit, Coring, Boring, Connectors, Pull String, Penetrations and Junction Boxes as Required. Conduit Must be Installed Prior to DataVox Installation

Video Surveillance Cameras

\$5,251.78





Intercom Software Programming

- 
1
DataVox
 Security Programming Labor for IP'ing Units. Customer is Responsible for Enrolling and Naming all Units into Existing VMS.
- OFE
1
OFE
 OFE Existing Intercom/Camera License and Manufacture Software Maintenance (if Required). Also, OFE Phone System Programming and SIP Endpoint Licenses for Integration and Intercom Call Communication.

Intercom Software Programming

\$410.00

Intercom Hardware

- 
1
Axis Communications
 01259-001 - 2N® IP Verso Wiegand Module
- 
1
Axis Communications
 2N® IP Verso 2M Surface Frame
- 
1
Axis Communications
 2N® IP Verso 2M Backplate
- 
1
Axis Communications
 2N® IP Security Relay
- 
1
Axis Communications
 IP Verso Bluetooth and RFID Reader, 125kHz, 13.56MHz Secured, NFC, Black

This document is confidential and the property of DataVox. Any copy or reuse of this document, its contents, recommendations and/or solutions in whole or part is strictly prohibited without prior written consent of DataVox.

Security Grant Project for Front Entry AXIS Upgrades



DVXB-22546

	1	Axis Communications 2N IP VERSO 2.0 - Main Unit with Camera	
	1	DataVox Access Control Door Field Device Testing	
	1	DataVox Miscellaneous Hardware For Mounting Components	
OFE	1	OFE Owner Furnished Existing Access Controlled Door with Door Controller, Card Reader, Electrified Hardware to be Released Via Intercom.	
OFE	1	OFE Owner Furnished Dedicated Low Voltage Conduit Cable Pathway from Security Device Location to Nearest MDF/IDF. This includes Conduit, Coring, Boring, Connectors, Pull String, Penetrations and Junction Boxes as Required. Conduit Must be Installed Prior to DataVox Installation	
			Intercom Hardware
			\$3,626.22

Network Equipment

OFE	1	OFE Owner Furnished Network Connectivity and Internet Services between Sites and Buildings	
OFE	1	OFE Owner Furnished Patch Panels, Rack Equipment, Mounting Hardware, and Cable Tray	
OFE	1	OFE Owner Furnished POE Network Switches for Security Devices in MDF/IDF Locations	
OFE	1	OFE Owner Furnished and Installed Server and Storage with included Video Management and/or Access Control Software	
			Network Equipment
			\$0.00

Security Cabling

	250	DataVox Security 18/4 Cabling	
	2	DataVox Miscellaneous Pathway Support and Cabling Material	
OFE	1	OFE Owner Furnished Composite Access Control Cabling from Central IDF Closet to Existing Card Reader Door Locations	
OFE	4	OFE Owner Furnished Cat5e/6/6A Cabling for Security Device Locations including Patch Cords, Patch Panels, and Rack Equipment	
			Security Cabling
			\$498.75

This document is confidential and the property of DataVox. Any copy or reuse of this document, its contents, recommendations and/or solutions in whole or part is strictly prohibited without prior written consent of DataVox.

DataVox Management Services





	1 DataVox Solution Architect Design and Engineering Services	
	1 DataVox DIR Contract Fee	
	1 DataVox Project Management Services - Planning, Scheduling, Order Processing, Construction Meetings and Close Out Design and Engineering Services - CAD/ Visio As-Built Drawings, Product Detail Information, and Configuration Documentation Commissioning Services - Testing, Tuning, and End User Training	
	DataVox Management Services	\$717.50
	Total:	\$11,119.25

K. E. Little Elementary **Installation Price**

Video Surveillance Software Programming

	1 DataVox Security Programming Labor for IP'ing Units. Customer is Responsible for Enrolling and Naming all Units into Existing VMS.	
OFE	3 OFE OFE Existing Camera License and Manufacture Software Maintenance (if Required)	
	Video Surveillance Software Programming	\$615.00

Video Surveillance Cameras

	1 Axis Communications P3738-PLV 4x4K Multi-Sensor Panoramic Camera with Deep Learning, 360 Degree IR Illumination	
	2 Axis Communications P4708-PLVE 2x8MP Dual-Sensor Camera, 30fps, 4K, 360° IR, Forensic WDR, Deep Learning DLPU, Zipstream	
	3 DataVox Demolition of Existing IP Cameras	
	1 DataVox Miscellaneous Hardware For Mounting Components	
OFE	1 OFE Owner Furnished and DataVox Installed Mounting Hardware for Cameras	

This document is confidential and the property of DataVox. Any copy or reuse of this document, its contents, recommendations and/or solutions in whole or part is strictly prohibited without prior written consent of DataVox.

OFE 3 **OFE**
 Owner Furnished Dedicated Low Voltage Conduit Cable Pathway from Security Device Location to Nearest MDF/IDF. This includes Conduit, Coring, Boring, Connectors, Pull String, Penetrations and Junction Boxes as Required. Conduit Must be Installed Prior to DataVox Installation

Video Surveillance Cameras **\$5,841.79**

Intercom Software Programming

 1 **DataVox**
 Security Programming Labor for IP'ing Units. Customer is Responsible for Enrolling and Naming all Units into Existing VMS.

OFE 1 **OFE**
 OFE Existing Intercom/Camera License and Manufacture Software Maintenance (if Required). Also, OFE Phone System Programming and SIP Endpoint Licenses for Integration and Intercom Call Communication.

Intercom Software Programming **\$410.00**

Intercom Hardware



1 **Axis Communications**
 01259-001 - 2N® IP Verso Wiegand Module



1 **Axis Communications**
 2N® IP Verso 2M Surface Frame



1 **Axis Communications**
 2N® IP Verso 2M Backplate



1 **Axis Communications**
 2N® IP Security Relay



1 **Axis Communications**
 IP Verso Bluetooth and RFID Reader, 125kHz, 13.56MHz Secured, NFC, Black



1 **Axis Communications**
 2N IP VERSO 2.0 - Main Unit with Camera

 1 **DataVox**
 Access Control Door Field Device Testing

 1 **DataVox**
 Miscellaneous Hardware For Mounting Components

OFE 1 **OFE**
 Owner Furnished Existing Access Controlled Door with Door Controller, Card Reader, Electrified Hardware to be Released Via Intercom.

OFE 1 **OFE**
 Owner Furnished Dedicated Low Voltage Conduit Cable Pathway from Security Device Location to Nearest MDF/IDF. This includes Conduit, Coring, Boring, Connectors, Pull String, Penetrations and Junction Boxes as Required. Conduit Must be Installed Prior to DataVox Installation

This document is confidential and the property of DataVox. Any copy or reuse of this document, its contents, recommendations and/or solutions in whole or part is strictly prohibited without prior written consent of DataVox.



	Intercom Hardware	\$3,626.22
--	--------------------------	-------------------

Network Equipment

- OFE** 1 **OFE**
Owner Furnished Network Connectivity and Internet Services between Sites and Buildings
- OFE** 1 **OFE**
Owner Furnished Patch Panels, Rack Equipment, Mounting Hardware, and Cable Tray
- OFE** 1 **OFE**
Owner Furnished POE Network Switches for Security Devices in MDF/IDF Locations
- OFE** 1 **OFE**
Owner Furnished and Installed Server and Storage with included Video Management and/or Access Control Software



	Network Equipment	\$0.00
--	--------------------------	---------------

Security Cabling

-  250 **DataVox**
Security 18/4 Cabling
-  1 **DataVox**
Miscellaneous Pathway Support and Cabling Material
- OFE** 1 **OFE**
Owner Furnished Composite Access Control Cabling from Central IDF Closet to Existing Card Reader Door Locations
- OFE** 4 **OFE**
Owner Furnished Cat5e/6/6A Cabling for Security Device Locations including Patch Cords, Patch Panels, and Rack Equipment

	Security Cabling	\$446.25
--	-------------------------	-----------------

DataVox Management Services

-  1 **DataVox**
Solution Architect Design and Engineering Services
-  1 **DataVox**
DIR Contract Fee
-  1 **DataVox**
Project Management Services - Planning, Scheduling, Order Processing, Construction Meetings and Close Out
Design and Engineering Services - CAD/ Visio As-Built Drawings, Product Detail Information, and Configuration Documentation
Commissioning Services - Testing, Tuning, and End User Training

	DataVox Management Services	\$717.50
--	------------------------------------	-----------------

This document is confidential and the property of DataVox. Any copy or reuse of this document, its contents, recommendations and/or solutions in whole or part is strictly prohibited without prior written consent of DataVox.



	Total:	\$11,656.76
--	---------------	--------------------

Gator Academy	Installation Price
----------------------	---------------------------

Video Surveillance Software Programming

	1		DataVox	Security Programming Labor for IP'ing Units. Customer is Responsible for Enrolling and Naming all Units into Existing VMS.	
	1	OFE	OFE	OFE Existing Camera License and Manufacture Software Maintenance (if Required)	
					Video Surveillance Software Programming
					\$205.00

Video Surveillance Cameras

	1		Axis Communications	P3268-LVE 8MP Outdoor Varifocal Dome Camera High-performance fixed dome camera with Deep Learning Processing Unit (DLPU). Forensic WDR, Lightfinder 2.0 and Optimized IR. Discreet, dust- and IK10 vandal-resistant outdoor casing	
	1		DataVox	Demolition of Existing IP Cameras	
	1		DataVox	Miscellaneous Hardware For Mounting Components	
	1	OFE	OFE	Owner Furnished Dedicated Low Voltage Conduit Cable Pathway from Security Device Location to Nearest MDF/IDF. This includes Conduit, Coring, Boring, Connectors, Pull String, Penetrations and Junction Boxes as Required. Conduit Must be Installed Prior to DataVox Installation	
					Video Surveillance Cameras
					\$1,331.91

Intercom Software Programming

	1		DataVox	Security Programming Labor for IP'ing Units. Customer is Responsible for Enrolling and Naming all Units into Existing VMS.	
	1	OFE	OFE	OFE Existing Intercom/Camera License and Manufacture Software Maintenance (if Required). Also, OFE Phone System Programming and SIP Endpoint Licenses for Integration and Intercom Call Communication.	
					Intercom Software Programming
					\$410.00







Intercom Hardware

	1		Axis Communications	01259-001 - 2N® IP Verso Wiegand Module	
--	---	---	----------------------------	---	--

This document is confidential and the property of DataVox. Any copy or reuse of this document, its contents, recommendations and/or solutions in whole or part is strictly prohibited without prior written consent of DataVox.

Security Grant Project for Front Entry AXIS Upgrades

DVXB-22546

	1	Axis Communications 2N® IP Verso 2M Surface Frame
	1	Axis Communications 2N® IP Verso 2M Backplate
	1	Axis Communications 2N® IP Security Relay
	1	Axis Communications IP Verso Bluetooth and RFID Reader, 125kHz, 13.56MHz Secured, NFC, Black
	1	Axis Communications 2N IP VERSO 2.0 - Main Unit with Camera
	1	DataVox Access Control Door Field Device Testing
	1	DataVox Miscellaneous Hardware For Mounting Components
OFE	1	OFE Owner Furnished Existing Access Controlled Door with Door Controller, Card Reader, Electrified Hardware to be Released Via Intercom.
OFE	1	OFE Owner Furnished Dedicated Low Voltage Conduit Cable Pathway from Security Device Location to Nearest MDF/IDF. This includes Conduit, Coring, Boring, Connectors, Pull String, Penetrations and Junction Boxes as Required. Conduit Must be Installed Prior to DataVox Installation

Intercom Hardware \$3,626.22

Network Equipment

OFE	1	OFE Owner Furnished Network Connectivity and Internet Services between Sites and Buildings
OFE	1	OFE Owner Furnished Patch Panels, Rack Equipment, Mounting Hardware, and Cable Tray
OFE	1	OFE Owner Furnished POE Network Switches for Security Devices in MDF/IDF Locations
OFE	1	OFE Owner Furnished and Installed Server and Storage with included Video Management and/or Access Control Software

Network Equipment \$0.00

Security Cabling

This document is confidential and the property of DataVox. Any copy or reuse of this document, its contents, recommendations and/or solutions in whole or part is strictly prohibited without prior written consent of DataVox.

Security Grant Project for Front Entry AXIS Upgrades

DVXB-22546

- OFE** 1 **OFE**
Owner Furnished Composite Access Control Cabling from Central IDF Closet to Existing Card Reader Door Locations
- OFE** 2 **OFE**
Owner Furnished Cat5e/6/6A Cabling for Security Device Locations including Patch Cords, Patch Panels, and Rack Equipment
- OFE** 1 **OFE**
Owner Furnished 18AWG Cabling for Trigger of Intercom Door Release

Security Cabling **\$0.00**

DataVox Management Services

-  1 **DataVox**
Solution Architect Design and Engineering Services
-  1 **DataVox**
DIR Contract Fee
-  1 **DataVox**
Project Management Services - Planning, Scheduling, Order Processing, Construction Meetings and Close Out
Design and Engineering Services - CAD/ Visio As-Built Drawings, Product Detail Information, and Configuration Documentation
Commissioning Services - Testing, Tuning, and End User Training

DataVox Management Services **\$717.50**

Total: **\$6,290.63**

Dickinson Continuation Center



Installation Price

Video Surveillance Software Programming

-  1 **DataVox**
Security Programming Labor for IP'ing Units. Customer is Responsible for Enrolling and Naming all Units into Existing VMS.
- OFE** 2 **OFE**
OFE Existing Camera License and Manufacture Software Maintenance (if Required)

Video Surveillance Software Programming **\$205.00**

Video Surveillance Cameras

-  1 **Axis Communications**
P3268-LVE 8MP Outdoor Varifocal Dome Camera High-performance fixed dome camera with Deep Learning Processing Unit (DLPU). Forensic WDR, Lightfinder 2.0 and Optimized IR. Discreet, dust- and IK10 vandal-resistant outdoor casing
-  1 **Axis Communications**
P4708-PLVE 2x8MP Dual-Sensor Camera, 30fps, 4K, 360° IR, Forensic WDR, Deep Learning DLPU, Zipstream

This document is confidential and the property of DataVox. Any copy or reuse of this document, its contents, recommendations and/or solutions in whole or part is strictly prohibited without prior written consent of DataVox.

Security Grant Project for Front Entry AXIS Upgrades

DVXB-22546

 2 **DataVox**
Demolition of Existing IP Cameras

 1 **DataVox**
Miscellaneous Hardware For Mounting Components

OFE 2 **OFE**
Owner Furnished Dedicated Low Voltage Conduit Cable Pathway from Security Device Location to Nearest MDF/IDF. This includes Conduit, Coring, Boring, Connectors, Pull String, Penetrations and Junction Boxes as Required. Conduit Must be Installed Prior to DataVox Installation

Video Surveillance Cameras **\$2,973.34**

Intercom Software Programming

 1 **DataVox**
Security Programming Labor for IP'ing Units. Customer is Responsible for Enrolling and Naming all Units into Existing VMS.

OFE 1 **OFE**
OFE Existing Intercom/Camera License and Manufacture Software Maintenance (if Required). Also, OFE Phone System Programming and SIP Endpoint Licenses for Integration and Intercom Call Communication.

Intercom Software Programming **\$410.00**

Intercom Hardware

 1 **Axis Communications**
01259-001 - 2N® IP Verso Wiegand Module

 1 **Axis Communications**
2N® IP Verso 2M Surface Frame

 1 **Axis Communications**
2N® IP Verso 2M Backplate

 1 **Axis Communications**
2N® IP Security Relay

 1 **Axis Communications**
IP Verso Bluetooth and RFID Reader, 125kHz, 13.56MHz Secured, NFC, Black

 1 **Axis Communications**
2N IP VERSO 2.0 - Main Unit with Camera

 1 **DataVox**
Access Control Door Field Device Testing

 1 **DataVox**
Miscellaneous Hardware For Mounting Components

This document is confidential and the property of DataVox. Any copy or reuse of this document, its contents, recommendations and/or solutions in whole or part is strictly prohibited without prior written consent of DataVox.

OFE	1	OFE Owner Furnished Existing Access Controlled Door with Door Controller, Card Reader, Electrified Hardware to be Released Via Intercom.	
OFE	1	OFE Owner Furnished Dedicated Low Voltage Conduit Cable Pathway from Security Device Location to Nearest MDF/IDF. This includes Conduit, Coring, Boring, Connectors, Pull String, Penetrations and Junction Boxes as Required. Conduit Must be Installed Prior to DataVox Installation	
		Intercom Hardware	\$3,626.22

Network Equipment

OFE	1	OFE Owner Furnished Network Connectivity and Internet Services between Sites and Buildings	
OFE	1	OFE Owner Furnished Patch Panels, Rack Equipment, Mounting Hardware, and Cable Tray	
OFE	1	OFE Owner Furnished POE Network Switches for Security Devices in MDF/IDF Locations	
OFE	1	OFE Owner Furnished and Installed Server and Storage with included Video Management and/or Access Control Software	
		Network Equipment	\$0.00

Security Cabling

OFE	1	OFE Owner Furnished Composite Access Control Cabling from Central IDF Closet to Existing Card Reader Door Locations	
OFE	3	OFE Owner Furnished Cat5e/6/6A Cabling for Security Device Locations including Patch Cords, Patch Panels, and Rack Equipment	
OFE	1	OFE Owner Furnished 18AWG Cabling for Trigger of Intercom Door Release	
		Security Cabling	\$0.00

DataVox Management Services

	1	DataVox Solution Architect Design and Engineering Services	
	1	DataVox DIR Contract Fee	

This document is confidential and the property of DataVox. Any copy or reuse of this document, its contents, recommendations and/or solutions in whole or part is strictly prohibited without prior written consent of DataVox.

	<p>1 DataVox Project Management Services - Planning, Scheduling, Order Processing, Construction Meetings and Close Out Design and Engineering Services - CAD/ Visio As-Built Drawings, Product Detail Information, and Configuration Documentation Commissioning Services - Testing, Tuning, and End User Training</p>	<p>DataVox Management Services \$717.50</p>
Total:		\$7,932.06

DHS Fieldhouse	Installation Price
-----------------------	---------------------------

Intercom Software Programming

	<p>1 DataVox Security Programming Labor for IP'ing Units. Customer is Responsible for Enrolling and Naming all Units into Existing VMS.</p>	
OFE	<p>1 OFE OFE Existing Intercom/Camera License and Manufacture Software Maintenance (if Required). Also, OFE Phone System Programming and SIP Endpoint Licenses for Integration and Intercom Call Communication.</p>	
Intercom Software Programming		\$410.00

Intercom Hardware

	<p>1 Axis Communications 01259-001 - 2N® IP Verso Wiegand Module</p>	
	<p>1 Axis Communications 2N® IP Verso 2M Surface Frame</p>	
	<p>1 Axis Communications 2N® IP Verso 2M Backplate</p>	
	<p>1 Axis Communications 2N® IP Security Relay</p>	
	<p>1 Axis Communications IP Verso Bluetooth and RFID Reader, 125kHz, 13.56MHz Secured, NFC, Black</p>	
	<p>1 Axis Communications 2N IP VERSO 2.0 - Main Unit with Camera</p>	
	<p>1 DataVox Access Control Door Field Device Testing</p>	
	<p>1 DataVox Miscellaneous Hardware For Mounting Components</p>	

This document is confidential and the property of DataVox. Any copy or reuse of this document, its contents, recommendations and/or solutions in whole or part is strictly prohibited without prior written consent of DataVox.

OFE 1 **OFE**
 Owner Furnished Existing Access Controlled Door with Door Controller, Card Reader, Electrified Hardware to be Released Via Intercom.

OFE 1 **OFE**
 Owner Furnished Dedicated Low Voltage Conduit Cable Pathway from Security Device Location to Nearest MDF/IDF. This includes Conduit, Coring, Boring, Connectors, Pull String, Penetrations and Junction Boxes as Required. Conduit Must be Installed Prior to DataVox Installation

Intercom Hardware **\$3,626.22**

Network Equipment

OFE 1 **OFE**
 Owner Furnished Network Connectivity and Internet Services between Sites and Buildings

OFE 1 **OFE**
 Owner Furnished Patch Panels, Rack Equipment, Mounting Hardware, and Cable Tray

OFE 1 **OFE**
 Owner Furnished POE Network Switches for Security Devices in MDF/IDF Locations

OFE 1 **OFE**
 Owner Furnished and Installed Server and Storage with included Video Management and/or Access Control Software

Network Equipment **\$0.00**

Security Cabling

 500 **DataVox**
 Security 18/6 Cabling

 2 **DataVox**
 5' Slim Cat 6 Patch Cable - Yellow

 2 **DataVox**
 Miscellaneous Pathway Support and Cabling Material

 250 **General Cable**
 DataVox Security Cat 6 Cabling

OFE 1 **OFE**
 Owner Furnished Composite Access Control Cabling from Central IDF Closet to Existing Card Reader Door Locations

 1 **Panduit**
 Cat 6 Modular Jack

 1 **Panduit**
 Cat 6 2 Port Surface Mount Box

Security Cabling **\$1,517.93**

This document is confidential and the property of DataVox. Any copy or reuse of this document, its contents, recommendations and/or solutions in whole or part is strictly prohibited without prior written consent of DataVox.

DataVox Management Services

	1	DataVox Solution Architect Design and Engineering Services	
	1	DataVox DIR Contract Fee	
	1	DataVox Project Management Services - Planning, Scheduling, Order Processing, Construction Meetings and Close Out Design and Engineering Services - CAD/ Visio As-Built Drawings, Product Detail Information, and Configuration Documentation Commissioning Services - Testing, Tuning, and End User Training	
		DataVox Management Services	\$512.50
		Total:	\$6,066.65

This document is confidential and the property of DataVox. Any copy or reuse of this document, its contents, recommendations and/or solutions in whole or part is strictly prohibited without prior written consent of DataVox.

ASSUMPTIONS AND EXCLUSIONS

This section lists DataVox's assumptions and exclusions for this Physical Security proposal.

- **Electrified Hardware:** Electrified hardware including mag locks, electrified panic/exit hardware, electrified strikes, electrified mortise/cylindrical locks, automatic operators, powered hinges, transfer cables, localized power supplies, integrated REXs, pneumatic push buttons, key switches, fire pulls, STI stoppers, ADA equipment, and exit signs will be provided and installed by others. Testing and certification of locks is required and DataVox is not responsible for manufacture defects or incorrect installation. DataVox will only make wire terminations for electrified locks inside rim enclosure. The door hardware installer is responsible for installing power transfer cable to door cable enclosure. AHJ code may require additional egress hardware to meet permitting requirements and may result in a change order. Existing hardware intended to be reused is assumed to be in place today and functioning properly to be reused on new system.
- **Badges/Credentials:** DataVox scope of work is based on customer utilizing existing badges or credentials. Customer must provide test badges with facility code, badge numbers, and card format prior to installation. Customer is responsible for mass employee badge enrollment and will be required to import existing users from old database and enroll credentials to new system prior to system cutover. DataVox is not responsible for badges being compatible with secondary systems such as shared building systems or time clock systems.
- **Intercoms:** Customer to provide all required IP addresses for intercoms prior to installation, including subnet and default gateway. All devices will be within 300ft of a network IDF/ switch when running category 6 cable segments. Unless otherwise defined in this scope of work, intercom communication is at the responsibility of the customer. SIP endpoint, softphones, licenses, mobile applications are outside of this scope of work. Integrated camera video and storage is not included in this scope of work.
- **Security Cameras:** Customer to provide all required IP addresses for cameras prior to installation, including subnet and default gateway. All exterior cameras will be mounted at a height of 12 to 14 feet from the ground. All cameras will be within 300ft of a network IDF/ switch when running category 6 cable segments. This scope of work includes aim, focus, and one time refocus of cameras to refine customer desired field of views. Additional modifications of cameras may require change order. Cameras included in this scope of work are designed for general surveillance at agreed upon locations. If specialty cameras, such as Pan/Tilt/Zoom, Facial Recognition, or License Plate Recognition cameras, are needed change order will be required.
- **Network Connectivity:** Administrative and remote VPN access to Customer's network is to be provided to DataVox during installation. Active network hardware and connectivity, such as but not limited to internet service, network connectivity between multiple IT closets or buildings, and fiber/copper backbone is to be provided by others.
- **Network Equipment:** Customer is responsible for providing a conditioned IT environment with equipment rack, cabinet, wire management, cable trays, and power. Active network gear such as surge protection, workstations, PC speakers/headsets, monitors, KVMs, patch panels, POE switches, and UPS/ battery back-up are to be provided and installed by others.
- **Server and Storage:** DataVox scope of work assumes Customer providing or reusing existing server/VM that meets manufacture recommended requirements. Customer responsible for video storage and DataVox can provided recommended sizing based on retention needs. Customer is responsible for server maintenance, upgrades, patches, backups, disaster recovery, and installing anti-virus/malware software on provided equipment to ensure optimum performance.
- **Cabling:** DataVox scope of work includes providing and installing security Cat 5e/6 cabling for some camera/IP device locations including patch cables, and some security 18 AWG or industry standard composite cabling for access control. If specific cable color is required and not included in this scope, change order may be needed. **Existing cabling intended to be reused is assumed to be functioning properly today with proper installation and slack for connecting new devices or change order may be required.**
- **Lift Rental:** lift rental and fuel costs are included in the project for 3 Locations (Day Rental). If additional rental time is required DataVox will provide extended rental time and bill back costs to the Customer.
- **Conduit:** All conduit, coring, boring, floor cores, back boxes, door rough in conduit, door cable enclosures, outdoor rated enclosures for all security devices will be provided by others. All conduits must be verified during installation process and cannot necessarily be deemed usable during the site survey or sales process. If conduit is proved to be inefficient (i.e. rotten, crushed or too small for additional cable runs), it will result in a change order. Equipment such as pedestals, concrete, bollards, motors, gate hardware, and poles are not included in this scope of work. Conduit pipe and junction boxes for garage, stairwells, high ceiling, and/or warehouse mounted devices as required will be provided by others. Hard deck ceilings will require pathway, wire mold, or cutting of sheetrock for cabling of devices. Patch, paint, and repair is not included in this scope of work.
- **Demo:** Unless otherwise stated in this scope of work, demo of existing equipment and cabling is at the responsibility of the customer.
- **Returns/Exchanges:** Restocking fee of 25% on all returnable items will apply. Special order items and licenses are non-refundable.
- **Recurring Subscriptions:** Subscription annual/multi-year pricing included in this scope of work is based on included device counts and current manufacture licensing requirements and pricing. Pricing is subject to change if manufacture license structure or pricing has changed at time of renewal. Any changes to account or additional devices added to account will also impact subscription pricing at renewal.

This document is confidential and the property of DataVox. Any copy or reuse of this document, its contents, recommendations and/or solutions in whole or part is strictly prohibited without prior written consent of DataVox.

Security Grant Project for Front Entry AXIS Upgrades

DVXB-22546

- **Stored Materials:** DataVox shall bill Customer for one hundred percent (100%) of all materials and equipment not incorporated into the work but delivered and suitably stored on-or offsite, and if applicable, a reasonable storage fee. Payment for such materials and equipment shall be made in accordance with the payment terms described herein. If requested, DataVox will provide:
 - Bill of Sale identifying the materials and equipment as the property of Customer
 - Evidence that all materials and equipment are insured for loss of any kind either at the stored location
 - Certificate of insurance; and
 - Photographic evidence of the stored materials and equipment.
- **Pricing Protection:** The pricing offered as of the date of this [Proposal/SOW] is based on the current pricing and availability of products. In the event tariffs, duties, or similar charges ("Tariffs") are imposed after the date and/or execution of this [Proposal/SOW], DataVox agrees to promptly notify Customer and make reasonable efforts to mitigate the impact of any Tariffs and avoid any price increases. If no viable alternatives are found, Customer shall be responsible for the price difference resulting from the Tariffs, provided that DataVox has exhausted all reasonable alternatives.
- **Non-DIR Related Items:** The following manufactures products are not included in the DIR Contract pricing of this proposal:
Miscellaneous Cabling Hardware

Acknowledged and Accepted

_____ *Initial*

BASELINE RESPONSIBILITIES

DataVox Responsibilities

This section lists DataVox's responsibilities for this Physical Security proposal.

- **Building Codes:** Install all equipment according to manufacturers' specifications, national and local building codes and regulations, and will be in conformity with good engineering practices.
- **ADA:** All equipment will be installed with provisions for the safety of the operator in accordance with the Americans with Disability Act (ADA) guidelines.
- **Dress Code:** All DataVox staff will dress in a professional manner displaying the DataVox logo. All DataVox staff will wear required Personal Protection Equipment (PPE). They will conduct themselves in a professional, courteous, and respectful manner to all others present.
- **Work Environment:** DataVox will maintain a clean working environment, storing tools and equipment when not in use and discarding refuse as often as reasonably possible. While DataVox cannot take responsibility for furniture or Customer furnished equipment in the workspace, DataVox will take reasonable precautions to protect all Customer furnished equipment, floors, walls, ceiling tiles, windows and window coverings, and furniture and other surfaces from damage, staining or unreasonable breakage while on site.
- **Supervision:** DataVox will appoint a Project Manager (PM) and/or Lead Technician (LT) to oversee the installation. During system implementation, please direct all communications through this designated contact. PM or LT will coordinate with other trades to facilitate and expedite project progress. DataVox will inform the Customer of any interference or potential delays which could impede implementation of the Physical Security system, thereby helping to avoid any additional charges.
- **Change Orders:** DataVox will provide written documentation of any Change Orders (CO) for work requested by the Customer which deviates from the original, approved Proposal and Scope of Works. CO's will be billed at our published labor rates plus materials, shipping, handling, restocking, and other charges imposed by suppliers.
- **Coordination Meetings:** DataVox recommends weekly coordination meetings between the Customer, DataVox and all other trades in which we will report to the Customer the status of the project. Any identified foreseeable restrictions or insurmountable issues outside our control that could impact the overall project schedule will be reviewed with the Customer.
- **DataVox Warranty:** A 90-day labor warranty will be included in this proposal, excluding Customer-provided equipment and existing cabling. All hardware will abide by manufacturer's warranty.

Customer Responsibilities

This section lists the Customer responsibilities for this Physical Security proposal.

- **Safe Work Environment:** Provide DataVox staff, contractors and others working on-site a safe working environment consistent with OSHA rules and regulations. DataVox reserves the right to refuse to work or install any equipment in an area where, at the sole discretion of DataVox, the safety of those involved is of concern.
- **Access to worksite:** Provide access to the worksite, and all work will typically take place between the hours of 07:00 and 17:00 Monday through Friday, except on public holidays, unless specified otherwise in the DataVox Proposal. Work completed at any other time will be billed at OT rates published in **Change Order Labor Rates**. For the safety of all concerned, it is requested that the work area be free and clear, for example, of other trades, clients of the Customer, and employees during the installation period.
- **Secure Storage:** Provide a secure, climate-controlled area on-site to store equipment during the installation period. Delivery of goods, supplies, and equipment to this on-site storage location, or equipment that has been installed in its designated location will be considered as 'Delivered' for billing purposes and will be invoiced accordingly. Responsibility for the equipment passes to the Customer immediately upon installation or delivery to the on-site storage. Any loss due to vandalism, theft, burglary, fire, water ingress, or any other means outside the direct control of DataVox shall be replaced at the Customer's expense.
- **Uninterrupted Workflow:** Provide availability of continuous, uninterrupted workflow in the environment in which the Physical Security will be installed. Delays in work caused by interference of other trades, inability to access the workspace during the stated hours, inability to access equipment stored on site, or other reasons caused by the Customer will be charged at rates published in **Change Order Labor Rates**. If DataVox crew arrives to work on-site at the appointed time and work cannot proceed due to dangerous conditions, inability to access the site, lack of power, interference by others which are within direct, reasonable control of the Customer, it will result in a half day charge for the crew.
- **Miscellaneous Items:** Additional items may be required for completion during project execution which DataVox or the customer did not foresee (for example, copper or fiber patch cables, power cords, and optics.) If miscellaneous items are required beyond what is included in the bill of materials, these items will be provided by the customer, or the items can be purchased from DataVox following the standard change management process.

Acknowledged and Accepted

_____ *Initial*

This document is confidential and the property of DataVox. Any copy or reuse of this document, its contents, recommendations and/or solutions in whole or part is strictly prohibited without prior written consent of DataVox.

PROJECT PRICING SUMMARY

Total Installation Price:	\$252,771.83
---------------------------	--------------

Grand Total:	\$252,771.83
---------------------	---------------------

Purchase Options

Cash Purchase Terms of Payment:

<i>Billing Milestones</i>		<i>Amount Due</i>
PO Required - Progress Payments (Multiple Invoices Upon Receipt of Goods/Work Completed) - Net 30	100.00 %	\$252,771.83
Total Payments (Excluding Sales Tax):		\$252,771.83

Acknowledged and Accepted _____
Initial

This document is confidential and the property of DataVox. Any copy or reuse of this document, its contents, recommendations and/or solutions in whole or part is strictly prohibited without prior written consent of DataVox.

ACCEPTANCE OF PROPOSAL

When (but only when) signed by buyer and an authorized representative of DataVox this shall be a binding, legal contract.

The prices, specifications, and conditions in this proposal are satisfactory, and are hereby accepted in their entirety. Buyer hereby agrees to purchase the Equipment and authorizes DataVox to do the work, and provide the materials specified, and payment will be made as outlined above. The price quoted in this Physical Security Proposal is based upon the Equipment included in this Physical Security Proposal. Any changes in the Equipment or installation may result in a change in the price. Any such change must be in writing, signed by all parties.

DataVox reserves the right to modify payment terms at any time based on a review of the Customer's credit.

THIS AGREEMENT, WHEN SIGNED BY BOTH PARTIES (BELOW), SHALL BE GOVERNED BY THE TERMS AND CONDITIONS IN THIS PHYSICAL SECURITY PROPOSAL. THERE ARE NO OTHER AGREEMENTS, OR WARRANTIES, ORAL OR WRITTEN, EXCEPT AS EXPRESSLY STATED IN THIS PHYSICAL SECURITY PROPOSAL. THIS AGREEMENT CANNOT BE MODIFIED EXCEPT IN WRITING SIGNED BY BOTH PARTIES.

Buyer acknowledges having read and understood all of the terms and conditions printed in this Physical Security Proposal and acknowledges receipt of a complete executed copy of this Agreement. Buyer understands and agrees that this Physical Security Proposal and all of the terms and conditions hereof shall be a binding, enforceable contract when signed by Buyer and by an authorized representative of DataVox.

Approval Signatures

IN WITNESS WHEREOF, the duly authorized representatives of the parties hereto have caused this Proposal to be duly executed.

DataVox, Inc.

Dickinson ISD

By: _____
(Signature)

By: _____
(Signature)

Name: _____

Name: _____

Title: _____

Title: _____

Date: _____

Date: _____

This document is confidential and the property of DataVox. Any copy or reuse of this document, its contents, recommendations and/or solutions in whole or part is strictly prohibited without prior written consent of DataVox.

TERMS AND CONDITIONS

In addition to the DataVox Standard Terms and Conditions found at <https://www.datavox.net/terms-and-conditions/>, the applicable DIR terms and conditions found at <https://www.datavox.net/state-purchasing-cooperatives/texas-dir/> apply to this Agreement. In the event of any conflict between the terms of the DataVox Standard Terms and Conditions and the DIR terms and conditions, the DIR terms and conditions shall prevail.

DICKINSON INDEPENDENT SCHOOL DISTRICT
BOARD AGENDA DOCUMENT

Meeting Date: April 21, 2025
Item Title: GMP #1 CTE Building
Agenda Item: Jim Rubach/Ryan Boone

Background Information:

Included in the 2023 Bond is the CTE building at the HS. Gamma Construction is the general contractor and has evaluated the proposals and the Guaranteed Maximum Price for package #1 is \$39,162,622. The GMP includes concrete, building envelope, plumbing, hvac, electrical, landscaping and applicable bonds/insurance. The GMP is within budget.

Recommendation:

The Superintendent, Executive Director of Facilities and Planning and Deputy Superintendent for Business and Operations recommend approval of GMP #1 for \$39,162,622.

Action Item: X Yes No

Motion made by _____ seconded by _____ vote _____

DICKINSON INDEPENDENT SCHOOL DISTRICT

EXECUTIVE BOARD AGENDA DOCUMENT

Meeting Date: April 21, 2025

Item Title: Executive Session

Agenda Item: President of the Board

The Board President will reconvene the Board to meet in Executive Session. If, during the course of the meeting covered by this Notice, the Board of Trustees should determine that a closed or executive meeting or session of the Board of Trustees is required, then such closed or executive meeting or session as authorized by **the Texas Open Meetings Act**, Texas Government Code **Section 551.001** et seq., will be held by the School Board at the date, hour, and place given in this Notice or as soon after the commencement of the meeting covered by this Notice as the School Board may conveniently meet in such closed or executive meeting or session concerning any and all purposes permitted by the Act, including but not limited to the following section(s) and purpose(s): Texas Government Code **Section 551.071** - Consultation with District's attorney regarding potential claim to be asserted by the District and concerning matters on which the attorney's duty to the District under the Texas Disciplinary Rules of Professional Conduct clearly conflicts with the Texas Open Meetings Laws; **Section 551.074** - for the purpose of considering the appointment, resignations, reassignment, evaluation, duties, discipline or dismissal of a public officer or employee or to hear complaints or charges against public officers or employees; **Section 551.082** school children; school district employees; disciplinary matter or complaint, and **Section 551.0821** for the purpose of considering a matter regarding a public school student where personally identifiable information about the student will necessarily be revealed by the deliberation.

Time To Executive Session: _____

Time Out of Executive Session: _____