



# HORIZON CITY TOD Form Based Code

DRAFT  
17 JANUARY 2025



TOWN OF  
HORIZON CITY

able.city

Architecture · Community Engagement  
Planning · Economic Development

## ACKNOWLEDGEMENTS

### TOWN OF HORIZON CITY – MAYOR & COUNCIL

Andres Renteria, City Mayor  
Walter Miller, Place 1  
Scott Quiroz, Place 2  
Rocio Ortega, Place 3  
Pat Randleel, Place 4  
Laura Urrutia, Place 5  
Rafael (Ralph) Padilla, Place 6  
Ruben Mendoza, Place 7

### TOWN OF HORIZON CITY – STAFF

David Ruiz, Planning Specialist & Board  
Secretary  
Art Rubio, AICP, CNU-a, Chief Planner  
Teresa Quezada, PhD, CNU-a, Capital  
Improvement Program Manager

### HORIZON ECONOMIC DEVELOPMENT CORPORATION

Eduardo Garcia, Executive Director  
Rafa Arellano, Business Development  
Manager

### CAMINO REAL REGIONAL MOBILITY AUTHORITY

Raymond L. Telles, Executive Director  
Robert C. Studer, Director of Finance

### CONSULTANTS



Edgar Fino, Project Director  
Cesar Nevarez, Project Manager  
Laura Nevarez



Architecture · Community Engagement  
Planning · Economic Development

Carlos Gallinar, AICP, CNU-a, Project  
Director  
Victoria Chavez, Project Manager  
Jason King, AICP, CNU-a, Designer  
Luis Escalante, Planner



Roman Bustillos, P.E., President & CEO  
Aaron Alvarado, R.P.L.S, Survey Project  
Manager

# TABLE OF CONTENTS

## Division 1: General Provisions

- Sec. 1.1 Purpose
- Sec. 1.2 Glossary of Terms
- Sec. 1.3 Acronyms

## Division 2: Transect Zones

- Sec. 2.1 Purpose, Intent and General Standards
- Sec. 2.2 Transect Zones
- Sec. 2.3 Permitted Uses
- Sec. 2.4 T5 Mixed Use Center
- Sec. 2.5 T4 Urban
- Sec. 2.6 T3 Sub-Urban
- Sec. 2.7 C Civic

## Division 3: Standards for Lots & Buildings

- Sec. 3.1 Purpose
- Sec. 3.2 Lot Standards
- Sec. 3.3 Accessory Dwelling Units
- Sec. 3.4 General Building Standards
- Sec. 3.5 Facades
- Sec. 3.6 Frontage Types
- Sec. 3.7 Site Standards

## Division 4: Thoroughfare Standards

- Sec. 4.1 Purpose
- Sec. 4.2 Street Hierarchy
- Sec. 4.3 General Standards
- Sec. 4.4 Street Lighting
- Sec. 4.5 Street Trees
- Sec. 4.6 Transit Shelters
- Sec. 4.7 Sidewalks and Pavement
- Sec. 4.8 Site Furniture
- Sec. 4.9 Thoroughfare Construction Standards
- Sec. 4.10 Street Network
- Sec. 4.11 Street Types

## Division 5: Site Development Standards

- Sec. 5.1 Purpose
- Sec. 5.2 Parking Standards
- Sec. 5.3 Signage Standards
- Sec. 5.4 Lighting Standards
- Sec. 5.5 Environmental

## Division 6: Landscape Standards

- Sec. 6.1 Title
- Sec. 6.2 Purpose
- Sec. 6.3 Application
- Sec. 6.4 Interpretation
- Sec. 6.5 Landscape Plans Required

- Sec. 6.6 General
- Sec. 6.7 Street Trees
- Sec. 6.8 Buffer Trees
- Sec. 6.9 Parking Lot Trees & Landscape Area
- Sec. 6.10 Project Trees
- Sec. 6.11 Project Trees & Project Shrubs
- Sec. 6.12 Landscape Screen
- Sec. 6.13 Ground Treatment
- Sec. 6.14 Irrigation
- Sec. 6.15 Stormwater Management
- Sec. 6.16 Environmental
- Sec. 6.17 Installation
- Sec. 6.18 Maintenance
- Sec. 6.19 Enforcement
- Sec. 6.20 Appeals
- Sec. 6.21 Violations & Penalty
- Sec. 6.22 Severability
- Sec. 6.23 Rules
- Sec. 6.24 Definitions

## Division 7: Irrigation Standards

- Sec. 7.1 Title
- Sec. 7.2 Valid License Required
- Sec. 7.3 Permit Required
- Sec. 7.4 Backflow Prevention Methods and Devices
- Sec. 7.5 Specific Conditions and Cross-Connection Control
- Sec. 7.6 Water Conservation
- Sec. 7.7 Irrigation Plans Required
- Sec. 7.8 Irrigation Standards
- Sec. 7.9 Completion of Irrigation System Installation
- Sec. 7.10 Maintenance, Alteration, Repair or Service of Irrigation Systems
- Sec. 7.11 Reclaimed Water
- Sec. 7.12 Advertisement Requirements
- Sec. 7.13 Contracts
- Sec. 7.14 Warranties for Systems
- Sec. 7.15 Duties and Responsibilities of City Irrigation Inspectors
- Sec. 7.16 Items Not Covered By This Ordinance
- Sec. 7.17 Enforcement
- Sec. 7.18 Definitions

## Division 8: Development Review Procedures

- Sec. 8.1 Purpose Parking Standards
- Sec. 8.2 Application
- Sec. 8.3 Master Site Plans
- Sec. 8.4 Environmental
- Sec. 8.5 Warrants, Exceptions, and Amendments
- Sec. 8.6 Inspection





# DIVISION 1: GENERAL PROVISIONS

## Sec. 1.1 Purpose

The Horizon City Transit Oriented Development (TOD) Code Regulations is a form based code which implements the mixed-use vision for the Horizon City community by:



- Providing for the organization of development through the establishment of Land Use zones.
- Providing for standards of development.

## Sec. 1.2 Glossary of Terms

### A

**Accessory Dwelling Unit:** Also referred to as accessory apartments, second units, or granny flats - are additional living quarters on single-family lots that are independent of the primary dwelling unit. The separate living spaces are equipped with kitchen and bathroom facilities, and can be either attached or detached from the Principal Building.

**Accessory Structure:** Any structure that is related to or in conjunction with the primary structure or use on a lot, such as patios, sheds or pools.

**Alley:** A service roadway that provides access to properties abutting another street and that is not intended for general traffic circulation.

**Attic:** The interior part of a building contained within a pitched roof structure.

**Awning:** A light, protective architectural element entirely supported by, but not permanently attached to a building.

### B

**Backbuilding:** A single-story structure connecting a Principal Building to an Outbuilding.

**Balcony:** An open habitable portion of an upper floor extending beyond a building's exterior wall that is not supported from below by vertical columns or piers but is instead supported by either a cantilever or brackets. An accessory area to a Dwelling, with one or more sides permanently open to the exterior except for a railing or parapet not exceeding four feet in height.

**Bioswale:** A linear landscape feature used to slow, collect, infiltrate, and filter stormwater that is vegetated with plants that can withstand moisture regimes ranging from flooded to dry that are designed to manage a specified amount of runoff from a large impervious area, such as a parking lot or roadway. A bioswale can accommodate larger quantities of stormwater and is deeper than a rain garden and is often greater in length than width.

**Block:** The aggregate of private Lots, Passages, and Alleys, circumscribed by Streets.

**Building Height:** The vertical distance between (1) the lowest permissible elevation above the existing grade which complies with finished floor elevation requirements as established by flood maps, the Health Department, or

building code, along the front of a building and (2) either the highest point of the coping of a flat roof, the deck line of a mansard roof, or the mean height level between eaves and ridge for gable, hip and gambrel roofs.

**Build-to-Zone (BTZ):** The range of allowable distances from the front property line along which the principal vertical plane of the building's primary façade shall be built in order to create a moderately uniform line of buildings along the street.

### C

**Canopy:** A roof or overhead unenclosed structure that provides shade or shelter from the elements.

**Civic Building:** A building designed specifically for a Civic Use.

**Civic Open Space:** A natural or landscaped outdoor area provided for the purpose of active or passive public recreation. It shall include publicly accessible outdoor amenities such as a playground, seating area, picnic area, multi-use path and temporary or permanent small outdoor performance space or religious facility.

**Civic Use:** A use that is open to the public at least some of the time and provides a focal point for community interaction and fosters citizen participation in civic activities, including churches, temples, synagogues, mosques, and other religious facilities; lodges; college or university facilities; exhibition halls and art galleries; grade schools; library; meeting halls; museum or similar facilities; performance theaters; post office; fire house; public administration offices; trade or specialty school facilities; or similar uses.

**Common Destination:** An area of focused community activity, usually defining the approximate center of a Pedestrian Shed. It shall include without limitation one or more of the following: a Civic Open Space; a Civic Building; a Commercial center; a Third Place; a Meeting Hall; or a transit station, and may act as the social center of a neighborhood.

**Cornice:** Projecting horizontal decorative molding along the top of a wall or building.

**Community Access Easement:** Street continuations onto private land that require build out as per street atlas. These can count to shorten the calculated block length.

### E

**Encroachment:** A structural or architectural element that breaks the plane of a vertical or horizontal regulatory limit extending into a Setback, into the Public Frontage, or into the Right-of-Way.

**Exception:** A type of amendment which permits a practice that is not consistent with a provision or the Intent of the Horizon City TOD Architectural Standards as determined by the City Administration. Exceptions shall be granted



only by the Town of Horizon City as set forth in Division 8 - Development Review Procedures.

**Expression Line:** A horizontal line, expressed by a material change or by a continuous projection not less than two inches nor more than one foot deep.

## F

**Façade:** The exterior wall of a building.

**Façade Transparency:** The amount of transparent window glass or other openings in the façade of a building, relative to the overall surface area of the façade.

**Final Site Plan:** A development plan authorizing construction and development within an approved Master Site Plan.

**Forecourt:** a Private Frontage wherein a portion of the Façade is close to the Frontage Line and the central portion is set back.

**Front Façade:** (Syn: Primary Façade)

**Front Street:** The street along the primary frontage of a lot.

**Frontage:** The area between a building Façade and the vehicular lanes or pedestrian-only Street, inclusive of its built and planted components.

**Frontage Line:** A Lot Line abutting a Street Right-of-Way.

**Frontage Buildout:** The minimum percentage of the lot width which must be occupied by building façade within the Build-To-Zone. For example, a property which is 100 feet wide with a Frontage Buildout of 60% would require that at least 60 feet of façade length be maintained in the Build-to-Zone. Any additional length of front façade would be allowed to step back further from the Build-to-Zone, if desired. The intent of this requirement is to encourage development to maximize their front façade exposure along the Street or Civic Open Space.

**Frontage Elements:** The structural and architectural elements which extend outward from the Façade of a building along Frontages, including awnings, canopies, galleries, porches and stoops, and which do not count as an extension of the Façade itself for the purposes of measuring setbacks and build-to-zone.

## G

**Gallery:** A covered passage that is open at one side, such as a portico or a colonnade. More specifically, it is a narrow balcony or platform running the length of a wall.

**Garden Wall:** A wall no greater than 48" in height that defines the Frontage Line and/or the perimeter of a property, dividing private areas from streets, rear lanes, or adjacent lots.

**Gas Station:** A commercial enterprise established for the purpose of retail sale or supply to motor vehicles of fuel, lubrication, minor repairs to tires, minor accessories, and including the customary space and facilities for the installation of such commodities on or in vehicles, but not

including space or facilities for storage, painting, repair, refinishing, body work, extensive mechanical work on or other servicing of motor vehicles.

**Ground Cover:** Low-growing plants other than turf grass or deciduous varieties, generally reaching a maximum height of not more than 24 inches at maturity, installed to form a continuous cover over the ground.

## H

**Habitable Space:** Space in a structure for living, sleeping, eating or cooking. Habitable space excludes parking garages, self-service storage facilities, warehouses, display windows separated from retail activity, bathrooms, toilet rooms, closets, halls, storage or utility spaces, and similar areas.

**Home Occupation:** Any for-profit activity carried out within, or on the same lot as, a residential dwelling unit, by a resident of such a dwelling unit.

**Hostel:** An overnight lodging facility for transient guests that provides communal or dormitory-style accommodations where transient residents can rent a bed, usually a bunk bed (as opposed to renting an entire unit, as in a hotel), and share a bathroom, lounge, and sometimes a kitchen. Rooms can be mixed or single-sex, although private rooms may also be available.

## L

**Liner Building:** A building specifically designed to mask a parking lot or a parking garage from a Frontage.

**Live-Work Unit:** Buildings or structures used jointly for commercial and residential purposes where the residential use of the space is secondary or accessory to the primary place of work. The commercial function may be anywhere in the unit. It is intended to be occupied by a business operator who lives in the same structure that contains the commercial activity or industry.

**Lot:** A parcel of land having specific boundaries and recorded as such in a deed or subdivision plat.

**Lot Coverage:** The portion of a Lot, expressed as a percentage, which may be occupied by a Principal Building and Accessory Structures, as well as sidewalks, patios, parking and loading areas, driveways, and other impermeable or man-made surfaces.

**Lot Line:** The lines abounding a Lot.

**Lot Line, Front:** The Lot Line dividing a Lot from a Street Right-of-Way. On a corner lot only one Lot Line shall be considered as a front lot line, where it is the Lot Line along the higher priority street on the street hierarchy.

**Lot Line, Rear:** The lot line opposite the Front Lot Line. In case of an irregular, triangular or gore-shaped lot, it shall mean a line within the lot, ten feet long, parallel to and at the maximum distance from the Front Lot Line.

**Lot Line, Side:** Any Lot Line which is not a Front Lot Line or Rear Lot Line.

**Lot Site Plan:** A plan developed for the construction on an individual parcel within a platted subdivision within the Horizon City TOD.

**Lot Width:** The length of the Primary Frontage Line of a Lot.

## M

**Master Site Plan:** A City Council approved plan depicting the proposed development of a neighborhood.

**Meeting Hall:** A building available for gatherings, including conferences, that accommodates at least one room equivalent to a minimum of 10 square feet per projected dwelling unit within the Pedestrian Shed in which it is located.

## O

**Open Space:** That portion of a development that is permeable and remains open and unobstructed from the ground to the sky, specifically excluding parking areas, whether permeable or impermeable.

**Outbuilding:** An accessory building, usually located toward the rear of the same Lot as a Principal Building. A Backbuilding sometimes connects it to the Principal Building.

## P

**Pedestrian Shed:** An area defined by the average distance that can be traversed at an easy walking pace from its edge to its center. This distance is applied to determine the size of a neighborhood or extent of a community. Pedestrian Sheds are oriented toward a central Common Destination. A standard Pedestrian Shed has an average ¼ mile or 1,320-foot radius, which is about the distance of a five minute walk at a leisurely pace.

**Place of Worship:** Any structure, used on a regular basis by a group of persons who assemble for religious worship, including, but not limited to, a church, synagogue, mosque, or temple.

**Playground:** A Civic Open Space designed and equipped for children's recreation.

**Porch:** An open air element of a building with a raised floor and a roof covering the floor that is supported by columns, posts, or piers. A porch may be located on more than one story.

**Primary Civic Open Space:** The main outdoor gathering place for a community. It is often, but not always, associated with an important Civic Building.

**Primary Façade:** The façade of a building that faces the street. In the case of a corner lot, it is the façade along the higher priority street on the street hierarchy.

**Primary Frontage:** The Frontage along the Primary Frontage Line.

**Primary Frontage Line:** (Syn: Front Lot Line)

**Principal Building:** The main building on a Lot, usually located toward the Frontage, that contains the principal use or uses.

**Principal Entrance:** The main point of access for pedestrians into a building.

**Property Line:** (Syn: Lot Line)

**Public Frontage:** The area between the Vehicular Lanes and the Frontage Line.

**Public Realm:** The physical and social domain of the public that is held in common either by their physical presence or by visual association. This includes, but is not limited to Plazas, Squares, Parks, Thoroughfares, Public Frontages, Private Frontages, Civic Buildings and Civic Open Spaces.

## R

**Rain Garden:** A small or residential landscape feature with a slight depression used to slow, collect, infiltrate, and filter stormwater that is vegetated with plants that can withstand moisture regimes ranging from flooded to dry.

**Regulating Plan:** A map that shows the physical locations and boundaries of Neighborhoods, primary streets, and Open Spaces subject to regulation by this TOD.

**Right-of-Way:** A strip of land dedicated, deeded, used or intended to be used, for a street, alley, walkway, boulevard, railroad, drainage facility, access for ingress or egress, electric transmission line, oil and gas pipeline, sanitary and stormwater sewer line, or other purpose by the public, certain designated persons, or governing bodies. It is an appropriation of the land to some public use made by the owner and accepted for such use by the public.

## S

**Settlement Founder:** The original holder of title to the area incorporated as the Horizon City TOD.

**Side Street:** The street along the secondary frontage of a lot.

**Sign Band:** An area on a building above the entrance(s) to tenant spaces that accommodates signage for each tenant.

**Single-Family Residence:** A building comprised of one or more rooms providing cooking, sleeping, and sanitary facilities, designed for the exclusive use of a single family.

**Small Footprint Tower:** A stand-alone structure that is significantly taller than it is wide, or a portion of a building that is significantly taller than it is wide and typically has more detail than the surrounding building(s). When a tower is a portion of a building, the tower eave or cornice is taller than the remainder of the building eave or cornice height and one or more of the tower façades is located forward of the remaining building façade.

**Story:** That part of a building contained between any floor and the floor or roof next above.

**Street:** A public or private thoroughfare which affords the

principal means of access to abutting property for use by motor vehicles, bicycles, and pedestrians. A street may be for use by pedestrians only or prohibit motor vehicles.

**Setbacks:** The minimum distance a building façade or parking area must be located from a frontage line or public right-of-way line.

**Streetscreen:** Sometimes called streetwall. A freestanding wall built along the frontage line, or coplanar with the facade, often for the purpose of masking a parking lot from the thoroughfare.

**T**

**Terminated Vista:** A building, structure, or portion of a building or structure, specifically designed to visually attract a viewer’s attention at the end of a visual axis, i.e. to terminate a view. A Terminated Vista may include towers, corner towers, symmetrical façades centered on a visual axis, an architecturally embellished entry, or similar distinctive architectural devices.

**Third Place:** A private building that includes a space conducive to unstructured social gathering. Third Places are usually bars, cafes, and corner stores.

**Thoroughfare:** A way for use by vehicular and pedestrian traffic, or pedestrian traffic only, and to provide access to Lots and Open Spaces, consisting of Public Frontage and often Vehicular Lanes.

**Trail Head:** The point at which a trail begins. Trail heads often contain rest rooms, sign posts and distribution centers for informational brochures about the trail and its features, and parking areas for vehicles and trailers.

**Transect (Transect Zone):** A planning and zoning tool that organizes zones in a continuum from rural to urban, referred to as T1, T2, T3, T4, T5, and T6 where T1 is the most rural and T6 is the most urban. Each Transect zone has common characteristics that facilitate form-based regulation.

**Tree Canopy Coverage:** The percent of land area that is covered by the layer of leaves, branches, and stems of trees that cover the ground when viewed from above.

**V**

**Vehicular Lanes:** the lanes providing traffic and parking capacity within a Thoroughfare. They usually consist of marked lanes in a variety of widths for parked and for moving vehicles.

**W**

**Warrant:** A type of amendment which permits a practice that is not consistent with a specific provision of the Horizon City Standards but is justified by the practice’s Intent as determined by the City. Warrants shall be granted administratively by the City Administrator or Designee.

**Workplace Access Easement:** Street continuations onto

private land that require build out as per street atlas. These can count to shorten the calculated block length.

**Sec. 1.3 Acronyms**

For the purposes of this TOD, the following acronyms shall have the meanings set forth below:

**Sec. 1.3.A. Acronyms**

**IDA:** International Dark-Sky Association

**Code:** Code of Ordinances

**TOD:** Transit Oriented Development





## DIVISION 2: TRANSECT ZONES

### Sec. 2.1 Purpose, Intent and General Standards

**Sec. 2.1.A.** The Transect is a planning and zoning tool that organizes zones in a continuum from rural to urban, referred to as T1, T2, T3, T4, T5, and T6. One additional zone is the Civic zone, which covers building types and uses that do not fit into any of the previous categories. For this particular TOD, only T3, T4, T5 and Civic transect zones are applicable. Each Transect Zone has a different set of characteristics that correspond with building placement, building form, and frontage standards, all of which influence the neighborhood.

**Sec. 2.1.B.** Each T3, T4, and T5 Transect Zone shall contain at least three different permitted residential building types. The permitted residential building types for each Transect Zone are established in Table 2-2.

#### **Sec. 2.1.C. *General Standards***

1. Precedent images are for illustrative purposes only to demonstrate the intent of the standards. They are provided as examples, and shall not imply that every element in the image is permitted.
2. The allocation of Transect Zones and required Civic Open Space by percentage are based on gross area allocated transect zones within the neighborhood.
3. Minimum residential density is measured for the total net acres allocated to each Transect Zone within the neighborhood. The net acre calculation does not include Rights-of-Way.
4. Accessory Dwelling Units do not constitute a separate unit for the purpose of calculating residential density

### Sec. 2.2 Transect Zones

Standards for each of the Transect Zones are shown for comparison in Table 2-1. Each zone is further described in Sec. 2.4 through Sec. 2.7.

Table 2-1: Transect Zones				
TABLE 2-1 TRANSECT STANDARDS SUMMARY	T3: SUB-URBAN	T4: URBAN	T5: MIXED USE CENTER	C: CIVIC
<b>BUILDING PLACEMENT</b>				
FRONT BUILD-TO-ZONE	12' MIN.	6' TO 18'	0' TO 10'	0' MIN.
FRONTAGE BUILDOUT (FRONT STREET)	40% MIN.	60% MIN.	75% MIN.	40% MIN.
FRONTAGE BUILDOUT (SIDE STREET)	30% MIN.	30% MIN.	30% MIN.	30% MIN.
SIDE SETBACK (MID-BLOCK)	5' MIN.	0' MIN.	0' MIN.	0' MIN.
SIDE BUILD-TO-ZONE (CORNER)	12' MIN.	6' TO 18'	0' TO 10'	0' MIN.
REAR SETBACK (LOT OR ALLEY)	5' MIN.	7' TO 10'	5' MIN	5' MIN
<b>LOT AND BLOCK STANDARDS</b>				
LOT WIDTH	40' MIN.	24' MIN., 200' MAX.	24' MIN., 180' MAX.	N/A
LOT DEPTH	80' MIN.	80' MIN., 300' MAX.	30' MIN., 180' MAX.	N/A
LOT COVERAGE	60% MAX.	70% MAX.	100% MAX.	100% MAX.
<b>BUILDING HEIGHTS</b>				
MAXIMUM BUILDING HEIGHT	2.5 STORIES	3 STORIES	3 STORIES MIN 4 STORIES	3 STORIES
FIRST FLOOR HEIGHT (FLOOR TO CEILING CLEAR)	9' MIN.	12' MIN. (C)	14' MIN. (C)	12' MIN.
GROUND FLOOR ELEVATION (ABOVE SIDEWALK OR FINISHED GRADE)	24" MIN. (RES.)	6" MAX. (C) 24" MIN. (RES.)	6" MAX. (C) 24" MIN. (RES.)	N/A
<b>PARKING LOCATION</b>				
FRONT SETBACK	30' MIN.	30' MIN.	N/A	30' MIN.
SIDE SETBACK (MID-BLOCK)	8' MIN.	0' MIN.	N/A	5' MIN.
SIDE SETBACK (CORNER)	20' MIN.	20' MIN.	N/A	30' MIN
REAR SETBACK	5' MIN.	5' MIN.	5' MIN. T5 PARKING IN REAR ONLY	5' MIN.
<b>ALLOWED ENCROACHMENTS</b>				
ALLOWED FRONTAGE TYPES	COMMON YARD, PORCH, STOOP	SHOPFRONT, FORECOURT, PORCH, STOOP, COMMON YARD	SHOPFRONT, FORECOURT, GALLERY, STOOP	N/A

C = COMMERCIAL  
 MAX. = MAXIMUM  
 MIN. = MINIMUM  
 RES = RESIDENTIAL

FIGURE 2-1: ILLUSTRATIVE PLAN

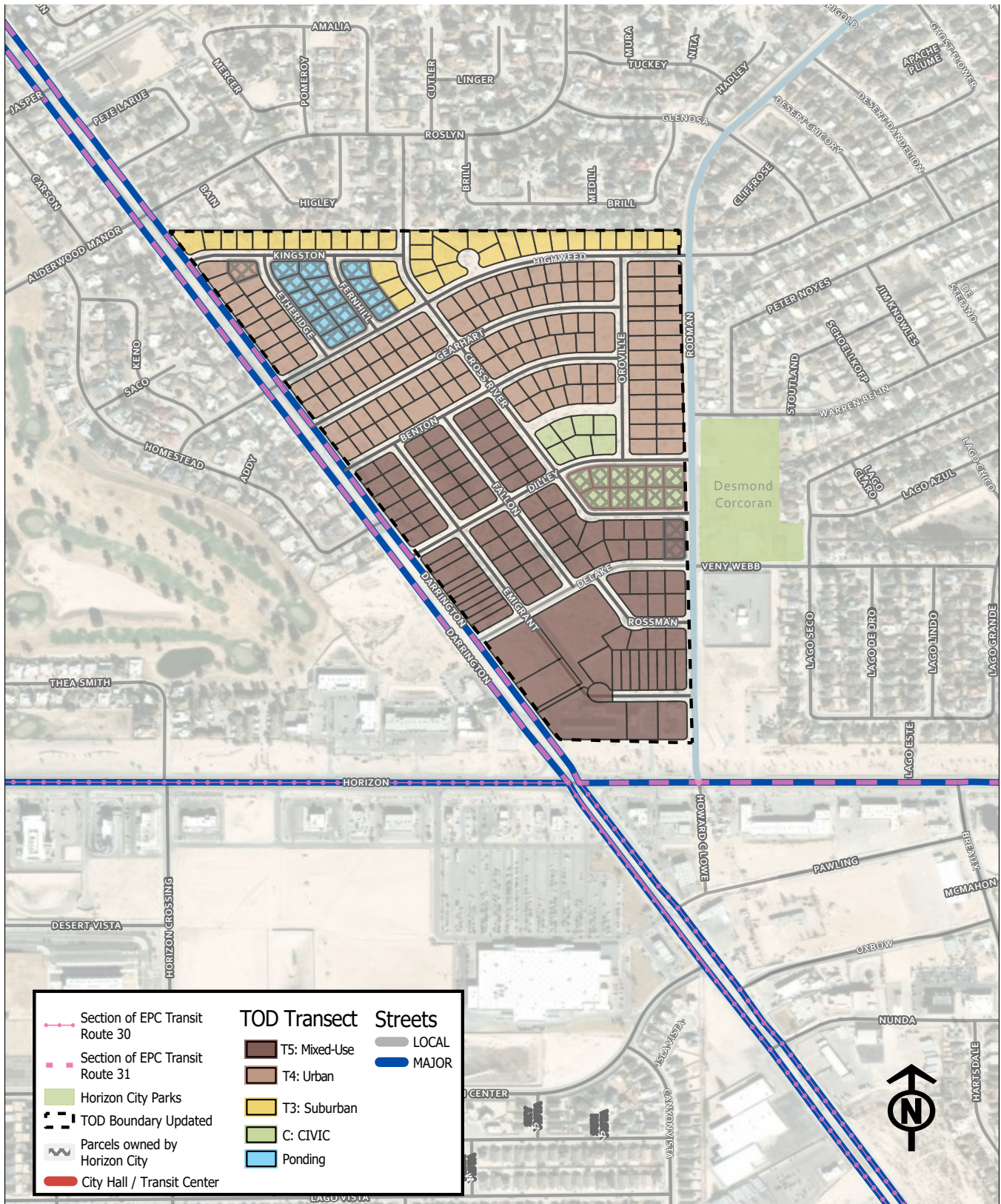



## Sec. 2.3 Permitted Uses

Sec. 2.3.A. Only those land uses that are listed in Permitted Uses Table 2-2 are the allowed land uses in the Horizon City TOD. As a general consideration, land uses not listed in the table are prohibited unless the applicant applies for a Warrant in accordance with Section 8.4.

Table 2-2: Permitted Uses

The allowable uses in each Transect Zone are as set forth in the Permitted Uses Table herein.

RESIDENTIAL TYPES	T3	T4	T5	C
MIXED USE BUILDING/BLOCK			■	
APARTMENT BUILDING		■	■	
MANSION APARTMENT		■		
LIVE/WORK UNIT			■	
TOWNHOUSE		■	■	
DUPLEX HOUSE	■	■		
COURTYARD HOUSE		■	■	
SIDEYARD HOUSE	■	■	■	
COTTAGE	■	■		
DETACHED, SINGLE FAMILY HOME	■			
ACCESSORY DWELLING UNIT	■			
RESIDENTIAL CONVERTIBLE TO RETAIL		□	■	

### LODGING

HOTEL (NO ROOM LIMIT)			■	
INN (UP TO 12 ROOMS)		□	■	
BED & BREAKFAST (UP TO 5 ROOMS)	□	□	■	
HOSTEL			□	
SCHOOL DORMITORY		■	■	

### OFFICE

OFFICE (GENERAL OR PROFESSIONAL)		□	■	
CO-WORKING SPACE		□	■	
LIVE-WORK UNIT			■	
HOME OCCUPATION	■	■	■	
AGRICULTURAL/ANIMAL/ VETERINARIAN FACILITY			□	
MEDICAL/DENTAL OFFICE		□	■	

### COMMERCIAL

NEIGHBORHOOD RETAIL (E.G., BOU- TIQUE, SMALL GROCERY)		■	■	
GENERAL RETAIL (E.G., DEPARTMENT STORE, SPECIALTY SHOPS)		□	■	
DISPLAY GALLERY			■	
RESTAURANT			■	■
KIOSK			■	■
PUSH CART			□	
FOOD TRUCK		□	□	□
LIQUOR SELLING ESTABLISHMENT			□	
MOVIE THEATER			■	

■ = By Right  
□ = By Warrant

**Table 2-2: Permitted Uses (Continued)**

The allowable uses in each Transect Zone are as set forth in the Permitted Uses Table herein.

COMMERCIAL (CONTINUED)	T3	T4	T5	C
OPEN-MARKET BUILDING (FARM MARKETS)	■	□	■	
BAR/TAVERN		□	■	
COFFEE SHOP		■	■	
FOOD HALL			■	
WINE-LIQUOR STORE		□	■	
MAKER SPACE (SMALL-SCALE MANUFACTURING)		□	■	
ARTISAN WORKSHOP (E.G., POTTERY, WOODWORKING)			■	
GYM/FITNESS STUDIO			■	

ENTERTAINMENT AND RECREATION	T3	T4	T5	C
MOVIE THEATER		■	■	
INDOOR RECREATION FACILITY (BOWLING ALLEY, ARCADE)			■	
EVENT VENUE (INDOOR/OUTDOOR)			■	■

CIVIC AND INSTITUTIONAL	T3	T4	T5	C
BUS SHELTER	■	■	■	■
COMMUNITY GARDEN	■	■	■	■
FOUNTAIN OR PUBLIC ART		■	■	■
LIBRARY				■
MUSEUM			□	■
AMPHITHEATER/OUTDOOR AUDITORIUM				■
PLAYGROUND				■
SURFACE PARKING LOT		■	■	■
RELIGIOUS ASSEMBLY	■	■	■	■
GOVERNMENT BUILDING & USE			□	■
COMMUNITY CENTER		□	■	
RELIGIOUS ASSEMBLY (CHURCH, MOSQUE, TEMPLE)	■	■	■	■
POST OFFICE		■	■	

CIVIL SUPPORT	T3	T4	T5	C
FIRE STATION			□	■
POLICE STATION			□	■
MEDICAL CLINIC			■	

EDUCATION	T3	T4	T5	C
COLLEGE				■
HIGH SCHOOL				■
TRADE SCHOOL				■
MIDDLE SCHOOL				■
ELEMENTARY SCHOOL				■
ADULT DAY CARE CENTER	■	■	■	■
CHILD DAY CARE CENTER	■	■	■	■

INDUSTRIAL	T3	T4	T5	C
ELECTRIC SUBSTATION	□	□	□	■
WIRELESS TRANSMITTER				■

TEMPORARY OR MOBILE	T3	T4	T5	C
POP-UP RETAIL/EVENT SPACE		□	■	■
FOOD TRUCKS		■	■	■



T5

## Sec. 2.4 T5 Mixed Use Center

### Sec. 2.4.A. Overview

This Transect Zone is found in the mixed-use commercial areas of the Horizon City TOD Urban Neighborhoods and may be found in other neighborhoods as well. Priority is placed on optimizing the physical characteristics of the built environment for increased walkability and a vibrant center with buildings located close to the sidewalk, plentiful shade for pedestrians, and parking lots screened from public view. This transect created a Main Street for the surrounding community.

### Sec. 2.4.B. Form

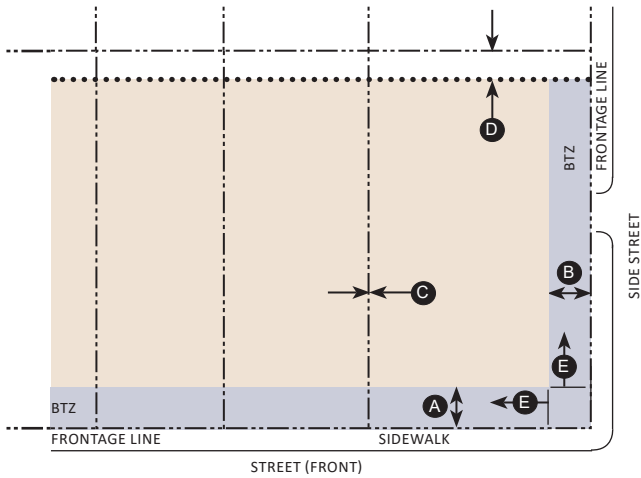

KEY	
--- FRONTAGE/PROPERTY LINE	..... SETBACK LINE
■ BUILD-TO-ZONE (BTZ)	■ POTENTIAL BUILDING AREA (IN ADDITION TO BTZ)

#### A. BUILDING PLACEMENT

SETBACKS		
FRONT BUILD-TO-ZONE	0' MIN., 10'MAX.	Ⓐ
SIDE STREET BUILD-TO-ZONE	0' MIN., 10'MAX.	Ⓑ
INTERIOR SIDE PROPERTY LINE SETBACK	0' MIN.	Ⓒ
REAR SETBACK	5' MIN.	Ⓓ
FRONTAGE BUILDOUT		
BUILDING FAÇADE WITHIN BUILD-TO-ZONE		
FRONT STREET FRONTAGE	75% MIN.	
SIDE STREET FRONTAGE	30% MIN.	
STREET FAÇADES MUST BE BUILT TO THE BTZ FOR THE FIRST 30' ON A CORNER. Ⓔ		

#### B. LOT AND BLOCK STANDARDS

LOT WIDTH	35' MIN., 330' MAX.
LOT DEPTH	30' MIN., 310' MAX.
LOT COVERAGE	80% MAX.
ALLEYS ARE REQUIRED IN T5 ZONES.	

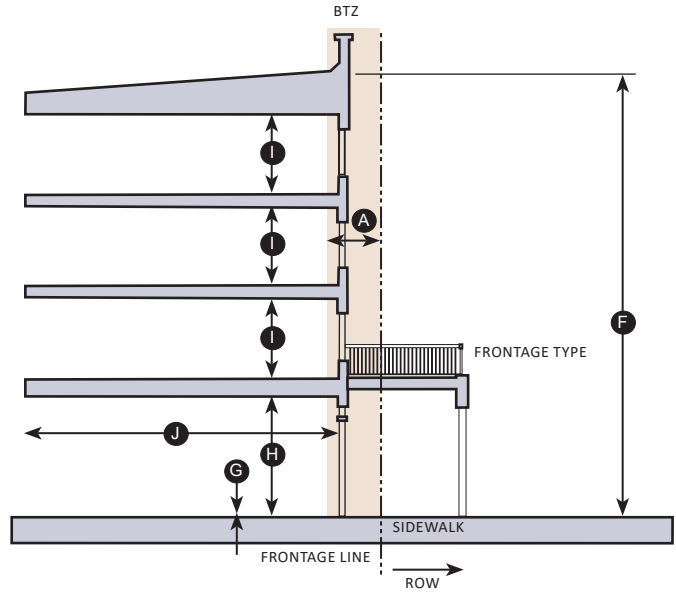

KEY	
--- FRONTAGE LINE	■ BUILDING
■ BUILD-TO-ZONE (BTZ)	

#### C. BUILDING FORM

HEIGHT		
BUILDING	4 STORIES MAX.	Ⓕ
GROUND FLOOR ELEV. ABOVE SIDEWALK	COMM. 6" MAX., RES. 24" MIN.	Ⓖ
GROUND FLOOR OFFICE / RETAIL CEILING	14' MIN. CLEAR	Ⓗ
CEILING HEIGHT	9' MIN. CLEAR	Ⓖ

#### FOOTPRINT

DEPTH, GROUND FLOOR COMMERCIAL SPACE:	30' MIN.	Ⓙ
---------------------------------------	----------	---

#### D. ALLOWED FRONTAGE TYPES

SHOPFRONT	GALLERY
FORECOURT	STOOP

\*SEE GENERAL STANDARDS FOR FRONTAGE DETAILS.



T5

Sec. 2.4.C. Parking & Encroachments

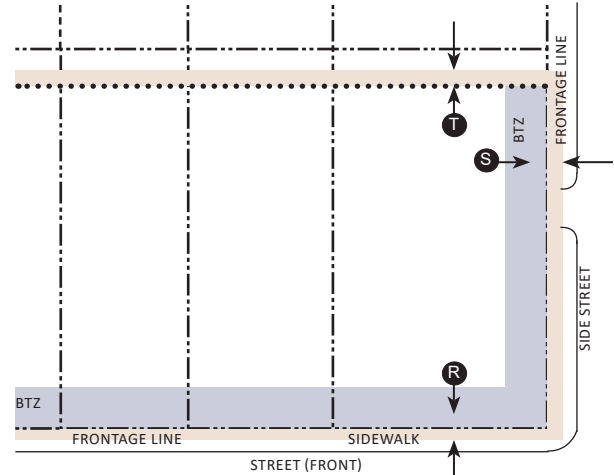
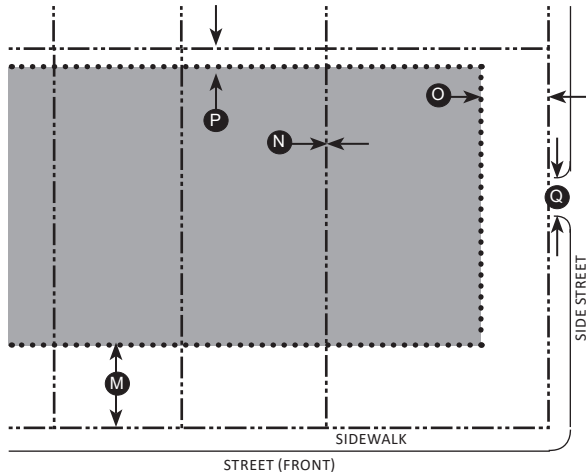

KEY

- FRONTAGE/PROPERTY LINE
- ..... SETBACK LINE
- █ PARKING AREA

KEY

- FRONTAGE/PROPERTY LINE
- ..... SETBACK LINE
- █ BUILD-TO-ZONE (BTZ)
- █ ENCROACHMENT AREA

**E. PARKING**

PARKING LOCATION (DISTANCE FROM PROPERTY LINE)

FRONT SETBACK	30' MIN.	(M)
SIDE SETBACK (MID-BLOCK)	0' MIN.	(N)
SIDE SETBACK (CORNER)	20' MIN.	(O)
REAR SETBACK	5' MIN.	(P)

DISTRICT SPECIFIC PARKING REQUIREMENTS

PARKING SHALL BE PROVIDED AS ESTABLISHED IN SECTION 5.2

PARKING SHALL BE LOCATED BEHIND THE FRONT FAÇADE OF BUILDINGS AND ACCESSED FROM ALLEYS OR SIDE STREETS WHENEVER POSSIBLE.

STREETSCREENS, GARDEN WALLS, FENCES, OR HEDGES ARE REQUIRED ALONG ALL UN-BUILT STREET RIGHT-OF-WAYS TO SHIELD VIEWS TO PARKING.

STREETSCREENS, GARDEN WALLS, FENCES, OR HEDGES HAVE A MAXIMUM HEIGHT OF 4' ALONG THE ALL FRONTAGES.

PARKING CURB CUT WIDTH	26' MAX.	(Q)
------------------------	----------	-----

**F. ALLOWED ENCROACHMENTS**

BALCONIES, BAY WINDOWS, AWNINGS, GALLERIES, STOOPS, AND OTHER FRONTAGE ELEMENTS

FRONT	12' MAX.	(R)
SIDE STREET	8' MAX.	(S)
REAR	4' MAX.	(T)

NOTE: FRONTAGE ELEMENTS SHALL ENCROACH FORWARD OF THE BUILD-TO-ZONE AND/OR INTO THE RIGHT-OF-WAY, BARRING ANY ADDITIONAL RESTRICTIONS BY THE PUBLIC ENTITY THAT HAS CONTROL OVER THE PUBLIC RIGHT-OF-WAY. A 6 FOOT MINIMUM SIDEWALK CLEAR ZONE MUST BE MAINTAINED.

**G. MISCELLANEOUS**

ALL BUILDINGS MUST HAVE A PRINCIPAL ENTRANCE ALONG THE FRONT FAÇADE.

LOADING DOCKS, OVERHEAD DOORS, AND OTHER SERVICE ENTRIES SHALL NOT BE LOCATED ON FAÇADES FACING STREETS OR ACROSS FROM, OR ADJACENT TO, CIVIC BUILDING FRONTAGES OR CIVIC OPEN SPACES, AND SHOULD INSTEAD BE LOCATED IN REAR SERVICE AREAS.

T4

## Sec. 2.5 T4 Urban

### Sec. 2.5.A. Overview

This Transect Zone provides a mix of uses and residential types in a pedestrian-oriented urban form. Buildings are typically attached with Front Façades located close to the sidewalk. This Transect Zone is appropriate at the center of Neighborhoods.

### Sec. 2.5.B. Form

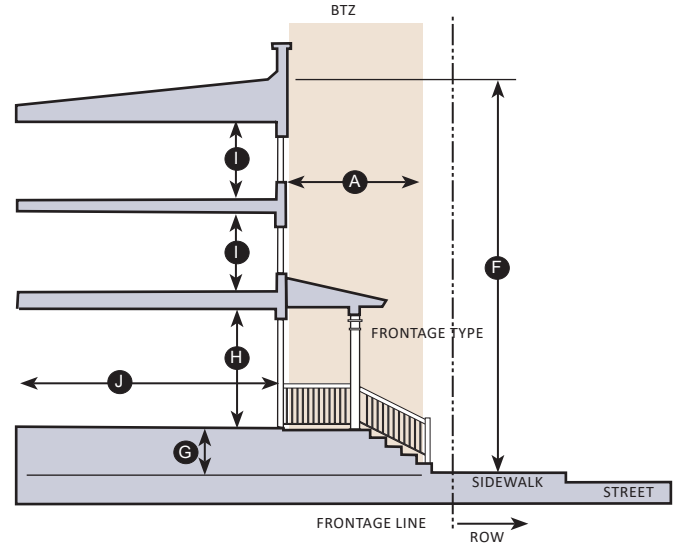
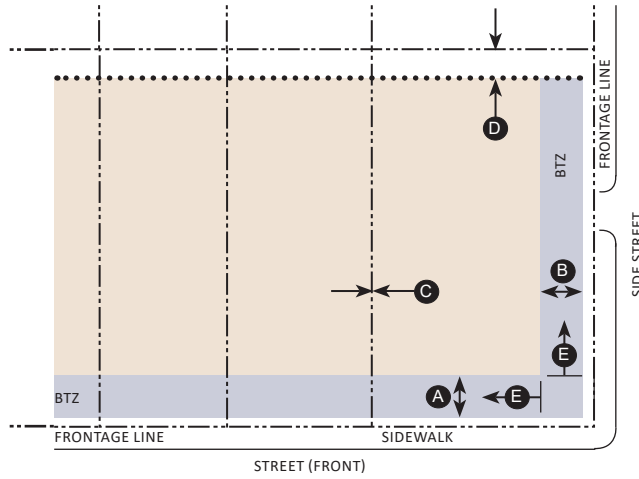

**KEY**

- FRONTAGE/PROPERTY LINE
- SETBACK LINE
- BUILD-TO-ZONE (BTZ)
- POTENTIAL BUILDING AREA (IN ADDITION TO BTZ)

**KEY**

- FRONTAGE LINE
- BUILDING
- BUILD-TO-ZONE (BTZ)

### A. BUILDING PLACEMENT

SETBACKS		
FRONT BUILD-TO-ZONE	6' MIN., 18'MAX.	A
SIDE STREET BUILD-TO-ZONE	6' MIN., 18'MAX.	B
INTERIOR SIDE PROPERTY LINE SETBACK	0' MIN.	C
REAR SETBACK	5' MIN.	D

FRONTAGE BUILDOUT		
BUILDING FAÇADE WITHIN BUILD-TO-ZONE		
FRONT STREET FRONTAGE	60% MIN.	
SIDE STREET FRONTAGE	30% MIN.	
STREET FAÇADES MUST BE BUILT TO THE BTZ FOR THE FIRST 30' ON A CORNER. <span style="float: right;">E</span>		

### B. LOT AND BLOCK STANDARDS

LOT WIDTH	70' MIN., 100' MAX.
LOT DEPTH	100' MIN., 130' MAX.
LOT COVERAGE	70% MAX.

ALLEYS ARE REQUIRED AT THE REAR OF ALL T4 LOTS.

### C. BUILDING FORM

HEIGHT		
MAIN BUILDING	3 STORIES MAX.	F
GROUND FLOOR ELEV. ABOVE SIDEWALK	COMM. 6" MAX., RES. 24" MIN.	G
GROUND FLOOR OFFICE / RETAIL CEILING	12' MIN. CLEAR	H
CEILING HEIGHT	9' MIN. CLEAR	I

FOOTPRINT		
DEPTH, GROUND FLOOR COMMERCIAL SPACE:	30' MIN.	J

### D. ALLOWED FRONTAGE TYPES\*

SHOPFRONT	GALLERY
FORECOURT	STOOP
PORCH	

T4

Sec. 2.5.C. Parking & Encroachments

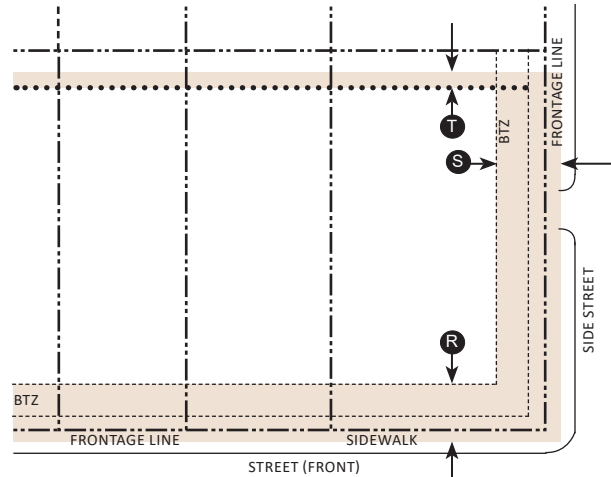
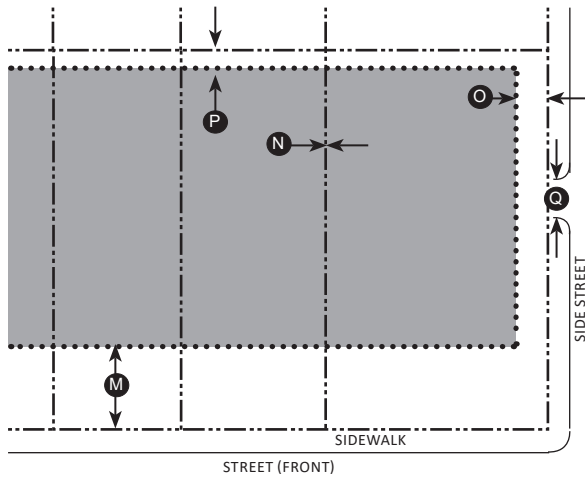

KEY

- FRONTAGE/PROPERTY LINE
- ..... SETBACK LINE
- PARKING AREA

KEY

- FRONTAGE/PROPERTY LINE
- ..... SETBACK LINE
- BUILD-TO-ZONE (BTZ)
- ENCROACHMENT AREA

**E. PARKING**

PARKING LOCATION (DISTANCE FROM PROPERTY LINE)

FRONT SETBACK	30' MIN.	M
SIDE SETBACK (MID-BLOCK)	0' MIN.	N
SIDE SETBACK (CORNER)	20' MIN.	O
REAR SETBACK	5' MIN.	P

DISTRICT SPECIFIC PARKING REQUIREMENTS

PARKING SHALL BE PROVIDED AS ESTABLISHED IN SECTION 5.2

PARKING SHALL BE LOCATED BEHIND THE FRONT FAÇADE OF BUILDINGS AND ACCESSED FROM ALLEYS OR SIDE STREETS WHENEVER POSSIBLE.

STREETSCREENS, GARDEN WALLS, FENCES, OR HEDGES ARE REQUIRED ALONG ALL UN-BUILT STREET RIGHT-OF-WAYS TO SHIELD VIEWS TO PARKING.

STREETSCREENS, GARDEN WALLS, FENCES, OR HEDGES HAVE A MAXIMUM HEIGHT OF 4' ALONG THE PRIMARY FRONTAGE AND UP TO THE PRIMARY STRUCTURE. THEY SHALL BE UP TO 6' ALONG ALL OTHER FRONTAGES.

GARAGE DOORS VISIBLE FROM PUBLIC VIEW (INCLUDING STREETS AND CIVIC SPACES) SHALL BE SINGLE WIDTH ONLY AND BE NO WIDER THAN 12'.

PARKING CURB CUT WIDTH	20' MAX.	Q
------------------------	----------	---

**F. ALLOWED ENCROACHMENTS**

BALCONIES, BAY WINDOWS, AWNINGS, GALLERIES, PORCHES, STOOPS, AND OTHER FRONTAGE ELEMENTS

FRONT	12' MAX.	R
SIDE STREET	8' MAX.	S
REAR	4' MAX.	T

NOTE: FRONTAGE ELEMENTS SHALL ENCROACH FORWARD OF THE BUILD-TO-ZONE AND/OR INTO THE RIGHT-OF-WAY, BARRING ANY ADDITIONAL RESTRICTIONS BY THE PUBLIC ENTITY THAT HAS CONTROL OVER THE PUBLIC RIGHT-OF-WAY. A 6 FOOT MINIMUM SIDEWALK CLEAR ZONE MUST BE MAINTAINED.

**G. MISCELLANEOUS**

ALL BUILDINGS MUST HAVE A PRINCIPAL ENTRANCE ALONG THE FRONT FAÇADE.

LOADING DOCKS, OVERHEAD DOORS, AND OTHER SERVICE ENTRIES SHALL NOT BE LOCATED ON FAÇADES FACING STREETS OR ACROSS FROM, OR ADJACENT TO, CIVIC BUILDING FRONTAGES OR CIVIC OPEN SPACES, AND SHOULD INSTEAD BE LOCATED IN REAR SERVICE AREAS.



T3

## Sec. 2.6 T3 Sub-Urban

### Sec. 2.6.A. Overview

This Transect Zone is predominately residential. Buildings are primarily detached with a few attached building types in this zone. The built environment in this area is intended to retain key features of walkability with front porches within conversation distance of the sidewalk.

### Sec. 2.6.B. Form

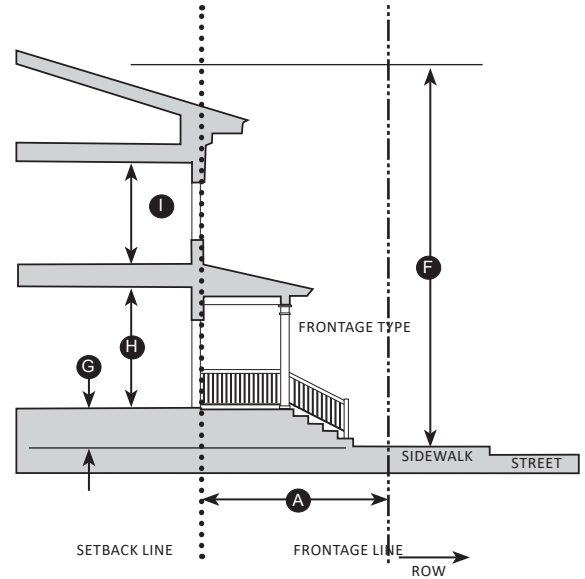
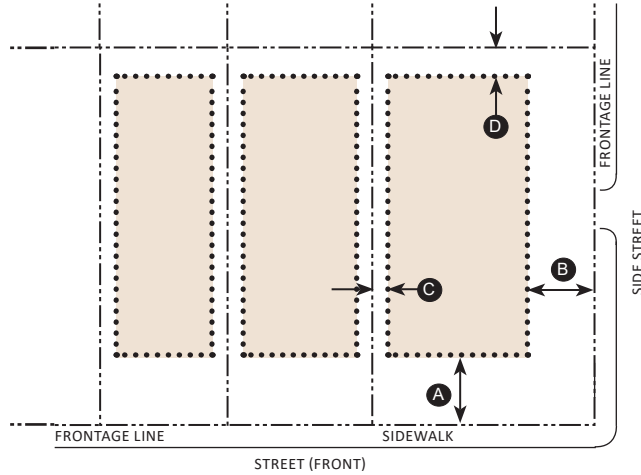

**KEY**

- FRONTAGE/PROPERTY LINE      ..... SETBACK LINE
- POTENTIAL BUILDING AREA

**KEY**

- FRONTAGE LINE      ..... SETBACK LINE
- BUILDING

### A. BUILDING PLACEMENT

SETBACKS		
FRONT BUILD-TO-ZONE	12' MIN.	(A)
SIDE BUILD-TO-ZONE (CORNER)	12' MIN.	(B)
SIDE SETBACK (MID-BLOCK)	5' MIN.	(C)
REAR SETBACK	10' MIN. / 7' MIN. AT ALLEY	(D)

FRONTAGE BUILDOUT	
BUILDING FAÇADE ALONG:	
FRONT STREET FRONTAGE	40% MIN.
SIDE STREET FRONTAGE	30% MIN.

### B. LOT AND BLOCK STANDARDS

MINIMUM LOT WIDTH	30' MIN.
LOT DEPTH	100' MIN., 160' MAX
LOT COVERAGE	60% MAX.

### C. BUILDING FORM

HEIGHT		
MAIN BUILDING	2.5 STORIES MAX.	(F)
GROUND FLOOR ELEV. ABOVE SIDEWALK	RES. 24" MIN.	(G)
GROUND FLOOR CEILING HEIGHT	9' MIN. CLEAR	(H)
CEILING HEIGHT	9' MIN. CLEAR	(I)

### D. ALLOWED FRONTAGE TYPES

COMMON YARD	PORCH
STOOP	

\*SEE GENERAL STANDARDS FOR FRONTAGE DETAILS.

T3

Sec. 2.6.C. Parking & Encroachments

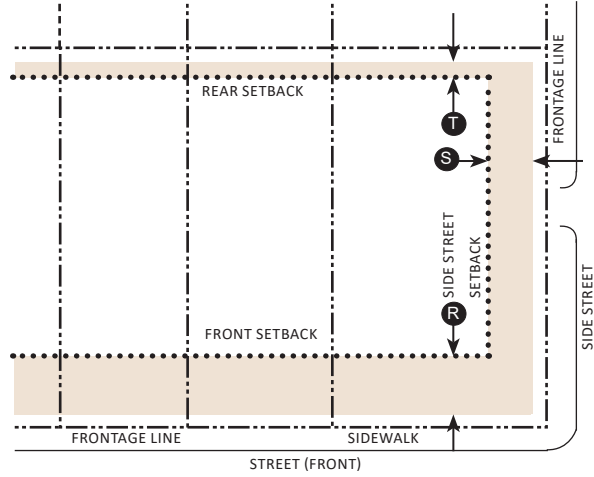
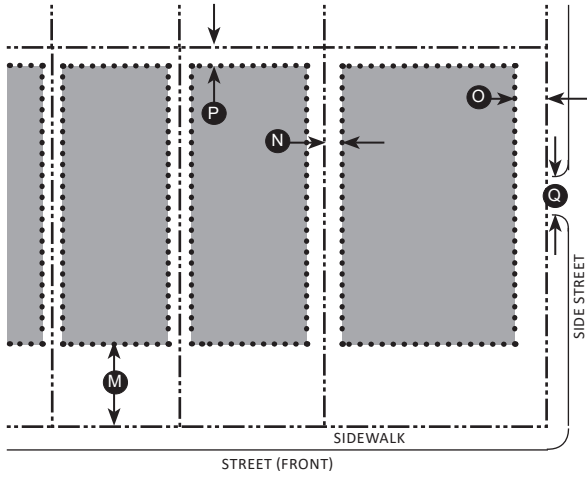

KEY

- FRONTAGE/PROPERTY LINE
- ..... SETBACK LINE
- PARKING AREA

**E. PARKING**

PARKING LOCATION (DISTANCE FROM PROPERTY LINE)

FRONT SETBACK	30' MIN.	(M)
SIDE SETBACK (MID-BLOCK)	8' MIN.	(N)
SIDE SETBACK (CORNER)	20' MIN.	(O)
REAR SETBACK	5' MIN.	(P)

DISTRICT SPECIFIC PARKING REQUIREMENTS

PARKING SHALL BE PROVIDED AS ESTABLISHED IN SECTION 5.2

PARKING SHALL BE LOCATED BEHIND THE FRONT FAÇADE OF BUILDINGS AND ACCESSED FROM ALLEYS OR SIDE STREETS WHENEVER POSSIBLE.

STREETSCREENS, GARDEN WALLS, FENCES, OR HEDGES ARE REQUIRED ALONG ALL UN-BUILT STREET RIGHT-OF-WAYS TO SHIELD VIEWS TO PARKING.

STREETSCREENS, GARDEN WALLS, FENCES, OR HEDGES HAVE A MAXIMUM HEIGHT OF 4' ALONG THE PRIMARY FRONTAGE AND UP TO THE PRIMARY STRUCTURE. THEY SHALL BE UP TO 6' ALONG ALL OTHER FRONTAGES.

GARAGE DOORS VISIBLE FROM PUBLIC VIEW (INCLUDING STREETS AND CIVIC SPACES) SHALL BE SINGLE WIDTH ONLY AND BE NO WIDER THAN 12'.

SHARED DRIVEWAYS BETWEEN ADJACENT LOTS IS ENCOURAGED TO REDUCE CURB CUTS.

~~CURB CUTS ON FRONT LOT LINE ARE NOT PERMITTED IF AN ALLEY IS PRESENT.~~

PARKING CURB CUT WIDTH (ONLY WHEN NO ALLEY IS PRESENT)	24' MAX. (12' MAX. FOR SINGLE-FAMILY)	(Q)
--	---------------------------------------	-----

KEY

- FRONTAGE/PROPERTY LINE
- ..... SETBACK LINE
- ENCROACHMENT AREA

**F. ALLOWED ENCROACHMENTS**

BALCONIES, BAY WINDOWS, AWNINGS, PORCHES, STOOPS, AND OTHER FRONTAGE ELEMENTS

FRONT	12' MAX.	(R)
SIDE STREET	8' MAX.	(S)
REAR	4' MAX.	(T)

NOTE: FRONTAGE ELEMENTS SHALL ENCROACH FORWARD OF THE SETBACK LINE, BUT SHALL NOT ENCROACH INTO THE RIGHT-OF-WAY.

**G. MISCELLANEOUS**

ALL BUILDINGS MUST HAVE A PRINCIPAL ENTRANCE ALONG THE FRONT FAÇADE.

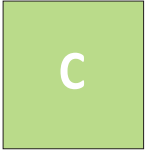

## Sec. 2.7 C Civic

### Sec. 2.7.A. Overview

Civic spaces are those areas that serve a public function or are dedicated to preserving and enhancing the public well-being. These areas shall contain passive or active civic uses dedicated to arts, culture, recreation, government, and transit. Reflecting the diverse nature of this Transect Zone, it is divided into two categories: Civic Open Spaces and Civic Buildings. It is difficult to determine beforehand the multiplicity of potential uses that may occupy these Civic spaces over time. Therefore, greater design flexibility shall be given to these sites with key development standards and guidelines, and buildings are to be subject to a greater degree of design review on a case-by-case basis.

### Sec. 2.7.B. Civic Open Spaces



Civic Open Space in the form of parks, greens, squares, plazas, playgrounds, pavilions, or recreational fields shall be located in each neighborhood at a minimum area greater than or equal to 5 percent of all land assigned a Transect Zone within the neighborhood.

#### (b) Guidelines



Heightened attention shall be paid to the quality of landscape design and function according to the following principles:

1. All designated Civic Open Spaces shall be accessible to the public.
2. The landscape design shall support and express environmental, cultural, and historical attributes.
3. The landscape design shall promote connection with nature, social interaction and mental restoration.
4. Views of natural features shall be preserved or maximized.
5. The landscape design shall promote connection to surrounding neighborhood resources, amenities and services, and provide for optimum accessibility, safety and way-finding.
6. Stormwater management improvements shall be integrated with the final landscape design as aesthetically and visually pleasing design elements.
7. Whenever appropriate, landscape design shall promote sustainability awareness and education through interpretive signs, demonstrations and other forms of interpretation.

The appropriate arrangements for Civic Open Spaces are described below and are permissible within proximity of the Transect Zones indicated in Table 2-3 Appropriate Arrangements for Civic Open Spaces.

#### (c) Civic Open Space Types

##### Square

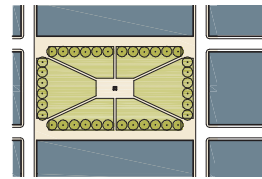

AVAILABLE FOR UNSTRUCTURED RECREATION AND PUBLIC GATHERINGS. A SQUARE IS SPATIALLY DEFINED BY BUILDING FRONTAGES. ITS LANDSCAPE SHALL CONSIST OF PATHS, LAWNS AND TREES, FORMALLY DISPOSED. SQUARES SHALL BE DENSELY SHADED AND PROVIDE SEATING. TREES AND SHRUBS SHALL BE OF SUFFICIENT QUANTITY AND LOCATED AS TO DEFINE A SPECIFIC GEOMETRY OF OPEN SPACE AND SHALL PROMOTE SECURITY BY ALLOWING VISIBILITY THROUGH ALL AREAS.

##### Plaza

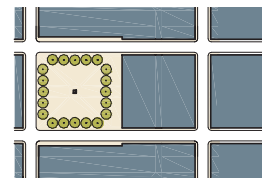

AVAILABLE FOR PUBLIC GATHERINGS AND OUTDOOR MARKETS. A PLAZA SHALL BE SPATIALLY DEFINED BY BUILDING FRONTAGES. ITS LANDSCAPE SHALL CONSIST PRIMARILY OF PAVEMENT. PLAZAS SHOULD USE PERVIOUS PAVERS, WHERE FEASIBLE. TREES ARE OPTIONAL.

##### Playground

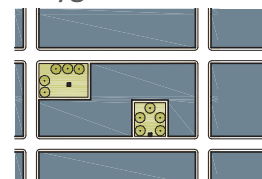

DESIGNED AND EQUIPPED FOR THE RECREATION OF CHILDREN. A PLAYGROUND SHOULD BE FENCED AND MAY INCLUDE AN OPEN SHELTER. PLAYGROUNDS SHALL BE INTERSPERSED WITHIN RESIDENTIAL AREAS AND MAY BE PLACED WITHIN A BLOCK. PLAYGROUNDS SHALL BE INCLUDED WITHIN PARKS, GREENS, AND SQUARES.

TABLE 2-3: APPROPRIATE ARRANGEMENTS FOR CIVIC OPEN SPACES				
CIVIC OPEN SPACE TYPE	TYPICAL SIZE	TRANSECT ZONE		
		T3	T4 T5	C
SQUARE	1,000 SF TO 2 ACRES		■	■
PLAZA	1,000 SF TO 4 ACRES		■	■
PLAYGROUND	1,000 SF TO 1 ACRE	■	■	■

**Sec. 2.7.C. Civic Building Standards**

(a) General

1. Civic Buildings shall include, but are not limited to, municipal buildings, religious facilities, libraries, schools, daycare centers, recreation facilities, and places of assembly.
2. The design and construction of Civic Buildings shall reflect the importance of these buildings within the community and with their function as landmarks in mind.

(b) Building Placement

Civic Buildings shall be sited in locations of particular geometric importance, such as anchoring a major Civic Open Space or terminating a street vista. Flexibility in building placement allows Civic Buildings to be distinguished from surrounding residential and commercial buildings and to be a prominent landmark in the community.

3. The scale of Civic Buildings should typically be larger than surrounding buildings in order to be more prominent and visible across greater distances.
4. Floor-to-floor heights and architectural details should be proportionately larger than those of private buildings that exist or are anticipated within adjacent blocks.
5. Prominent roof forms and additive elements such as cupolas can visually extend the height of the building. See Sec. 4.5. General Building Standards for more information.

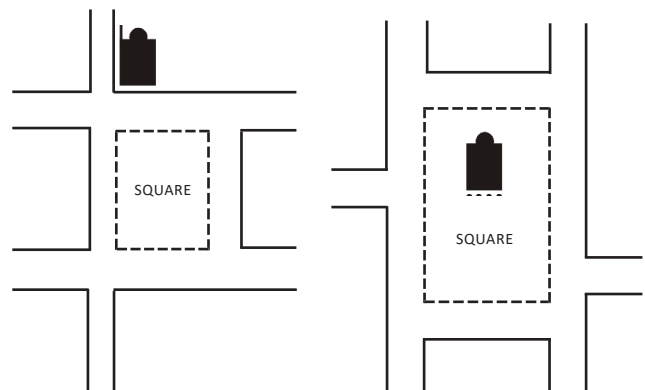
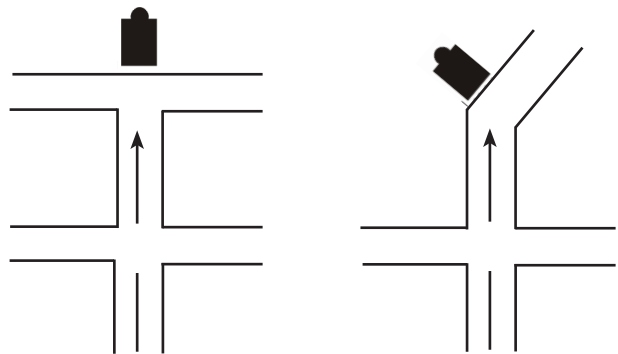

C

Sec. 2.7.D. Form

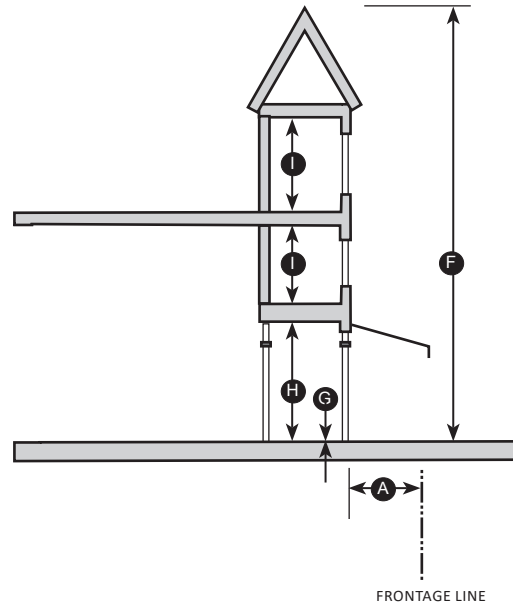
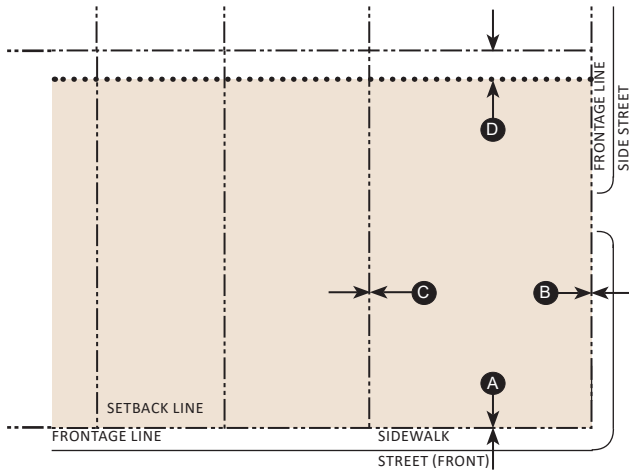

KEY

- FRONTAGE/PROPERTY LINE
- ..... SETBACK LINE
- POTENTIAL BUILDING AREA

KEY

- FRONTAGE LINE
- BUILDING
- BUILD-TO-ZONE (BTZ)

**A. BUILDING PLACEMENT**

SETBACKS		
FRONT SETBACK	0' MIN.	A
SIDE STREET SETBACK	0' MIN.	B
INTERIOR SIDE PROPERTY LINE SETBACK	0' MIN.	C
REAR SETBACK	5' MIN.	D

**FRONTAGE BUILDOUT**

BUILDING FAÇADE ALONG:	
FRONT STREET FRONTAGE	40% MIN. 30% MIN.
SIDE STREET FRONTAGE	

**B. LOT AND BLOCK STANDARDS**

LOT WIDTH	N/A
LOT DEPTH	N/A
LOT COVERAGE	100% MAX.

**C. BUILDING FORM**

HEIGHT		
MAIN BUILDING	3 STORIES MAX.	F
GROUND FLOOR ELEV. ABOVE SIDEWALK	N/A	G
GROUND FLOOR CEILING HEIGHT	12' MIN. CLEAR	H
CEILING HEIGHT	9' MIN. CLEAR	I

C

Sec. 2.7.E. Parking & Encroachments

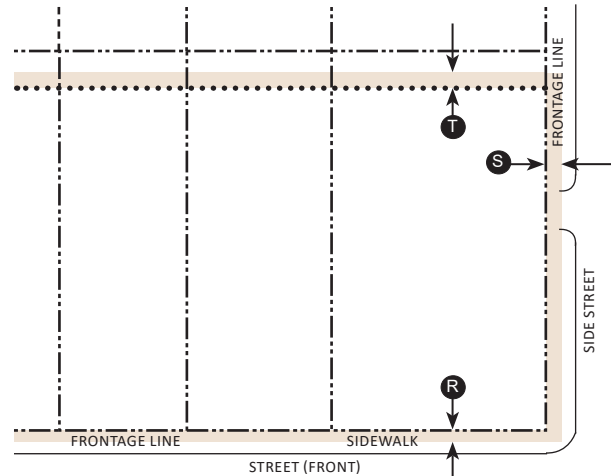
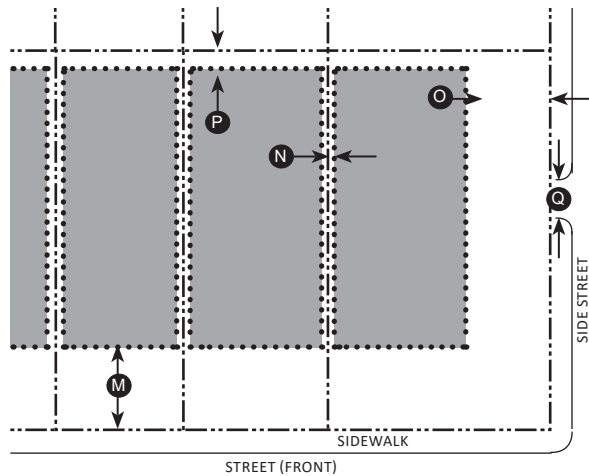

KEY

- FRONTAGE/PROPERTY LINE
- ..... SETBACK LINE
- █ PARKING AREA

KEY

- FRONTAGE/PROPERTY LINE
- ..... SETBACK LINE
- █ ENCROACHMENT AREA

**D. PARKING**

PARKING LOCATION (DISTANCE FROM PROPERTY LINE)

FRONT SETBACK	30' MIN.	(M)
SIDE SETBACK (MID-BLOCK)	5' MIN.	(N)
SIDE SETBACK (CORNER)	30' MIN.	(O)
REAR SETBACK	5' MIN.	(P)

DISTRICT SPECIFIC PARKING REQUIREMENTS

PARKING SHALL BE PROVIDED AS ESTABLISHED IN SECTION 5.2

PARKING SHALL BE LOCATED BEHIND THE FRONT FAÇADE OF BUILDINGS AND ACCESSED FROM ALLEYS OR SIDE STREETS WHENEVER POSSIBLE.

STREETSCREENS, GARDEN WALLS, FENCES, OR HEDGES ARE REQUIRED ALONG ALL UN-BUILT STREET RIGHT-OF-WAYS TO SHIELD VIEWS TO PARKING.

WHEN A CIVIC BUILDING IS LOCATED WITHIN A CIVIC SPACE COMPLETELY SURROUNDED BY STREETS, THEN PARKING SHALL BE ACCOMMODATED ON-STREET OR WITHIN MID-BLOCK LOCATIONS WITHIN 1/4 MILE OF THE CIVIC BUILDING'S FRONT DOOR.

PARKING CURB CUT WIDTH	20' MAX.	(Q)
------------------------	----------	-----

**E. ALLOWED ENCROACHMENTS**

BALCONIES, BAY WINDOWS, AWNINGS, AND OTHER FRONTAGE ELEMENTS

FRONT	12' MAX.	(R)
SIDE STREET	8' MAX.	(S)
REAR	4' MAX.	(T)

NOTE: FRONTAGE ELEMENTS SHALL ENCROACH FORWARD OF THE BUILD-TO-ZONE AND/OR INTO THE RIGHT-OF-WAY, BARRING ANY ADDITIONAL RESTRICTIONS BY THE PUBLIC ENTITY THAT HAS CONTROL OVER THE PUBLIC RIGHT-OF-WAY. A 6 FOOT MINIMUM SIDEWALK CLEAR ZONE MUST BE MAINTAINED.

**F. MISCELLANEOUS**

ALL BUILDINGS MUST HAVE A PRINCIPAL ENTRANCE ALONG THE FRONT FAÇADE.





# DIVISION 3: STANDARDS FOR LOTS & BUILDINGS

## Sec. 3.1 Purpose

Sec. 3.1.A. This Division establishes standards for lots and individual buildings within the Horizon City TOD. Topics including Accessory Units, Building Standards, Façades, Frontage Types, and Site Standards.

## Sec. 3.2 Lot Standards

### Sec. 3.2.A. Front and Backs

Buildings and lots have fronts, sides, and backs and how these relate to one another forms neighborhood character.

1. Front Façades, the main presentation faces of buildings or Lots containing the Principal Entrance, should face the Public Realm.
2. The backs of buildings and lots, which are the private or service side, should face mid-block areas and be screened from view. Backs of buildings or Lots shall not abut the Frontage Line.
3. Sides of buildings and Lots shall face either the Frontage Line or be concealed mid-block.
4. Thoroughfares, with the exception of Alleys, should be faced with the fronts or sides of buildings and lots.
5. Alleys and mid-block parking areas should be faced with the backs or sides of buildings and Lots.
6. The backs of buildings and Lots shall not be across from, or adjacent to, a Civic Open Space.
7. The backs of buildings and Lots shall not face Civic Building Frontages.

Sec. 3.2.B. The table below outlines the range of relationships between the fronts, sides, and backs of buildings and Lots.

## Sec. 3.3 Accessory Dwelling Units

Sec. 3.3.A. One Principal Building and one Accessory Dwelling Unit may be built by right on each single-family Lot as permitted by Table 2-2.

FRONTS FACING FRONTS	IDEAL
FRONTS FACING SIDES	ACCEPTABLE
FRONTS FACING BACKS	PROHIBITED
SIDES FACING BACKS	ACCEPTABLE
BACKS FACING BACKS	IDEAL
SIDES FACING SIDES	IDEAL

TABLE 3-1: FACING SIDES

8. Accessory Dwelling Units are allowed an additional 10% of the lot coverage to calculate maximum square footage.
9. Each single-family Lot may accommodate one Accessory Dwelling Unit in the T3 Transect Zone.
10. Accessory Dwelling Units shall be limited to 2 Stories, including ground floor parking.
11. Accessory Dwelling Units are not computed towards overall density or unit calculations.

## Sec. 3.4 General Building Standards

Buildings shall comply with the following:

### Sec. 3.4.A. Heights

General building height information is provided below. Refer to the Transect Standards for setback and height information specific to each Transect Zone.

1. A Story is that part of a building contained between any finished floor and the floor or roof next above. Habitable attics (space within the roof structure) are permitted and are not considered Stories for the purpose of determining Building Height.
2. Stories shall not exceed 9 feet in height from finished floor to finished ceiling, except for a first floor commercial or residential function, which shall be a minimum of 12 feet and shall be a maximum of 14 feet. Mezzanines extending beyond 33% of the floor area shall be counted as an additional Story.
3. A story is measured as a half story if:
  - a. (See Figure 3-1) For sloped roofs having a pitch between 4:12 and 12:12, if dormers are present on no more than 50% of the building length along each building elevation. Where dormers exceed 50% of any building length, it is considered a full story, or;
  - b. For flat roofs having a pitch less than 2:12, the total finished area of the half story is no more than 50% of the total finished floor area of the story immediately below and the half story is setback a minimum of 5' from the building edge on edges that face a street lot line or a common lot line abutting a protected district.
4. Building Height shall be measured as the vertical distance between (1) the lowest permissible elevation above the existing grade which complies with finished floor elevation requirements as established by flood maps, the Health Department, or building code, along the front of a building and (2) either the highest point of the coping of a flat roof, the deck line of a mansard roof, or the mean

height level between eaves and ridge for gable, or hip roofs.

landmarks. They are commonly placed to terminate vistas.

1. Small Footprint Towers/Cupolas with a footprint



FIGURE 3-1: BUILDING STORY

5. Roof structures including chimneys, parapet walls not over four feet high, tanks and supports, elevator machinery or shafts, penthouses used solely to enclose stairways and air conditioning equipment, provided that such structures do not exceed 10% of the roof structure measured on a horizontal plane, are not used for human occupancy, and provided that the use of such structure does not exceed the district height requirements by more than 8 feet.

**Sec. 3.4.B. Small Footprint Towers / Cupolas**

These features, as well as steeples, spires and belfries on Places of Worship, are designed to extend above the roofline. and are generally intended to be visual

smaller than 30 feet by 30 feet may extend above the established Transect Zone Building Height.

**Sec. 3.4.C. Principal Entrances**

The Principal Entrance of every Principal Building must be located along the Primary Façade and directly face a Street or Civic Open Space. Additional building entrances are permitted.

**Sec. 3.4.D. Entry / Exit Doors**

Public entry and exit doors which swing outward shall be recessed into the façade a minimum of three feet where the sidewalk abuts the building.

Sec. 3.5 Façades

**Sec. 3.5.A. Wide Façades**

Building façades longer than 50 feet shall be varied with at least one change of architectural expression. These changes in expression may be a vertical element running from the ground plane to the roof, a change in fenestration, color, or texture, or a break in building façade plane or roof line. These changes may be subtle or significant, but should soften the visual effect of very wide buildings, especially those directly across the street from narrower buildings. Strive for an appearance of authenticity when subdividing a large façade into multiple

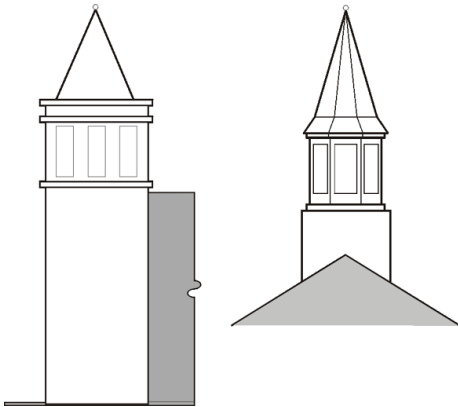

FIGURE 3-2: SMALL FOOTPRINT TOWER AND CUPOLA

smaller façades resembling distinct buildings.

**Sec. 3.5.B. Façade Transparency**

All building Façades which face onto a Street or Civic Open Space shall meet the minimum transparency requirements outlined herein. The percentage of transparency per Story shall be calculated within the area between finished floor and finished ceiling and shall be a total percentage of doors and windows along that portion of the façade.

1. Buildings with Shopfront
  - (a) Minimum building façade transparency for ground Story: 70 percent and should allow a view of at least five 5 feet of interior space.
  - (b) Minimum building façade transparency for upper Stories: 30 percent.
2. Buildings without a Shopfront
  - (a) Minimum building façade transparency for ground Story: 30 percent.
  - (b) Minimum building façade transparency for upper Stories: 20 percent.

**Sec. 3.5.C. Shopfronts**

1. The top of all shopfront window sills shall be between 1 and 3 feet above the adjacent sidewalk.
2. Shopfront windows shall extend up from the sill at least 8 feet above the adjacent sidewalk.
3. Shopfronts shall have a Cornice or Expression Line between the first and second story.
4. Shopfront windows shall not be made opaque by

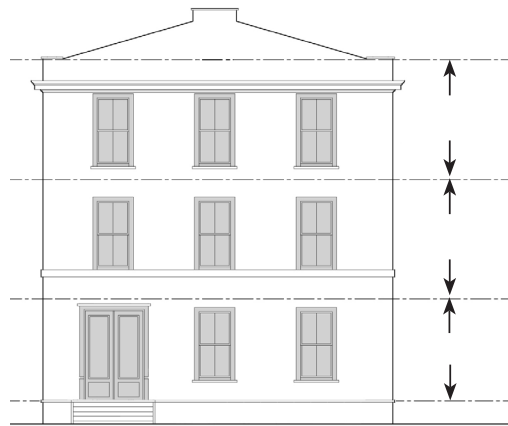

FIGURE 3-4: FAÇADE TRANSPARENCY REQUIREMENTS FOR BUILDINGS WITHOUT SHOPFRONT.

5. window treatments.
6. Shopfront windows shall use only ultra-clear high performance glass. Reflective, frosted, tinted, or textured glass is prohibited on shopfronts.
7. Doors or entrances for public access shall be provided at intervals no greater than 50 feet, unless otherwise approved. The intent is to maximize street activity, to provide pedestrians with frequent opportunities to enter buildings, and to minimize any expanses of inactive wall space.
8. Shopfront doors shall contain at least 60 percent transparent glass. Solid doors are prohibited.
9. The minimum depth of Habitable Space required behind each shopfront on the Primary Façade is provided in the Transect Zone Standards for each Transect Zone. This ensures that the area behind shopfronts is sufficient enough to be an actively used retail space.

**Sec. 3.5.D. Encroachments**

When structural or architectural elements, such as Balconies, Bay Windows, Awnings, etc., or Frontage Elements are to extend over or into public sidewalks or Right-of-Way, the property owner shall be required to enter into a right-of-way agreement establishing the property owner’s responsibility for repairing any damage that may result from public maintenance or improvements. Requirements and standards for Encroachments are provided in the Transect Zone Standards for each Transect Zone.



FIGURE 3-3 FAÇADE TRANSPARENCY REQUIREMENTS FOR BUILDINGS WITH SHOPFRONT.

### Sec. 3.6 Frontage Types

Sec. 3.6.A. Building frontages shall conform with the basic Frontage Types described in this section.

1. The illustrations and photographs provided are for illustrative purposes.



FIGURE 3-5: ANATOMY OF A SHOPFRONT.

1. Awning or Canopy

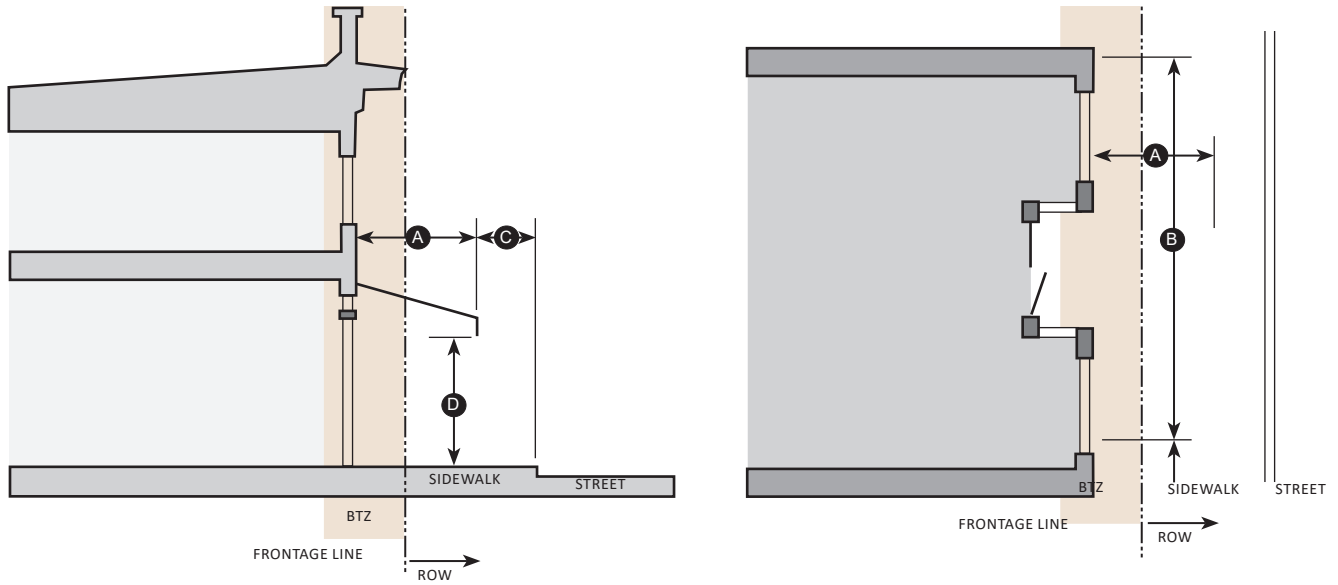

KEY

- FRONTAGE/PROPERTY LINE
- BTZ BUILD-TO-ZONE (BTZ)

A. DESCRIPTION

WHEN A BUILDING HAS A SHOPFRONT AND THE FRONT FAÇADE OF THE BUILDING IS AT OR NEAR THE FRONTAGE LINE IT SHALL INCLUDE A CANOPY OR AWNING ELEMENT THAT OVERLAPS THE SIDEWALK ALONG THE MAJORITY OF THE FRONTAGE. THE CANOPY IS A STRUCTURAL CANTILEVERED SHED ROOF AND THE AWNING IS CANVAS OR SIMILAR MATERIAL AND IS OFTEN RETRACTABLE.

B. SIZE

DEPTH	4' MIN.	(A)
WIDTH, CUMULATIVE	70% OF FAÇADE WIDTH MIN.	(B)
SETBACK FROM CURB	2' MIN.	(C)
HEIGHT, CLEAR	8' MIN.	(D)

C. MISCELLANEOUS

DOORS SHALL BE RECESSED AS LONG AS FRONT FAÇADE IS AT BTZ.

OPEN ENDED AWNINGS ARE ENCOURAGED.

ROUNDED AND HOOPED AWNINGS ARE DISCOURAGED.



A SHOPFRONT WITH A RECESSED DOORWAY.



A SHOPFRONT WITH A CHAMFERED CORNER ENTRY.

2. Gallery

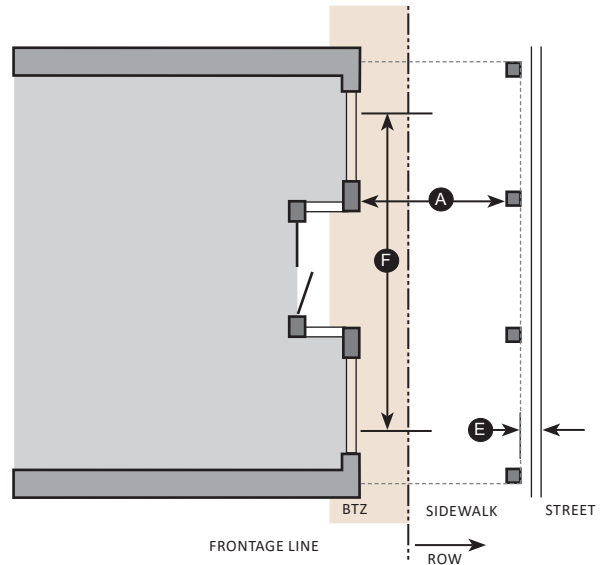
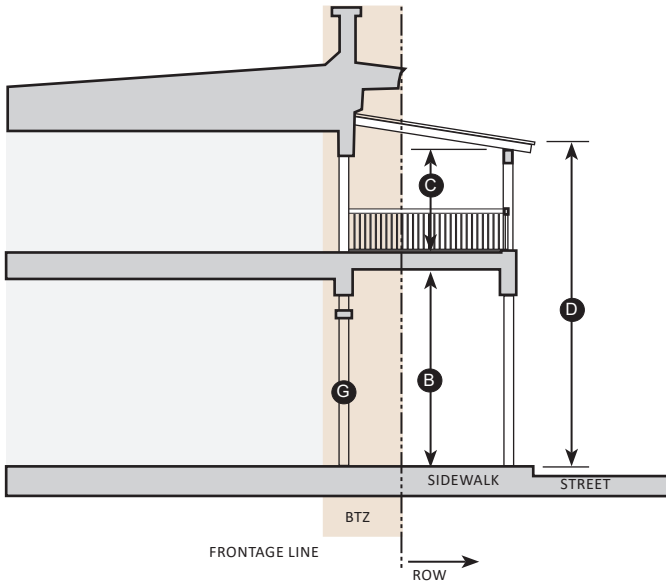

- KEY
- FRONTAGE/PROPERTY LINE
  - BTZ BUILD-TO-ZONE (BTZ)

**A. DESCRIPTION**

THE FRONT FAÇADE OF THE BUILDING IS AT THE BUILD-TO-ZONE AND THE GALLERY ELEMENT OVERLAPS THE SIDEWALK, ELIMINATING THE NEED FOR AN AWNING OR CANOPY. THIS FRONTAGE TYPE IS INTENDED FOR BUILDINGS WITH GROUND-FLOOR COMMERCIAL OR RETAIL USES AND SHALL BE ONE OR TWO STORIES IN HEIGHT.

**B. SIZE**

DEPTH, CLEAR	8' MIN.	<b>A</b>
GROUND FLOOR HEIGHT, CLEAR	11' MIN.	<b>B</b>
UPPER FLOOR HEIGHT, CLEAR	9' MIN.	<b>C</b>
HEIGHT	2 STORIES MAX.	<b>D</b>
SETBACK FROM CURB	2' MIN.	<b>E</b>
WIDTH	75% OF FAÇADE WIDTH MIN.	<b>F</b>

**C. MISCELLANEOUS**

GALLERIES MUST ALSO FOLLOW ALL THE RULES OF THE SHOPFRONT FRONTAGE TYPE. **G**



A GALLERY WITH SLENDER METAL COLUMNS.



A WOOD FRAMED GALLERY.



A MASONRY GALLERY WITH HABITABLE SPACE ON THE SECOND FLOOR.



### 3. Forecourt

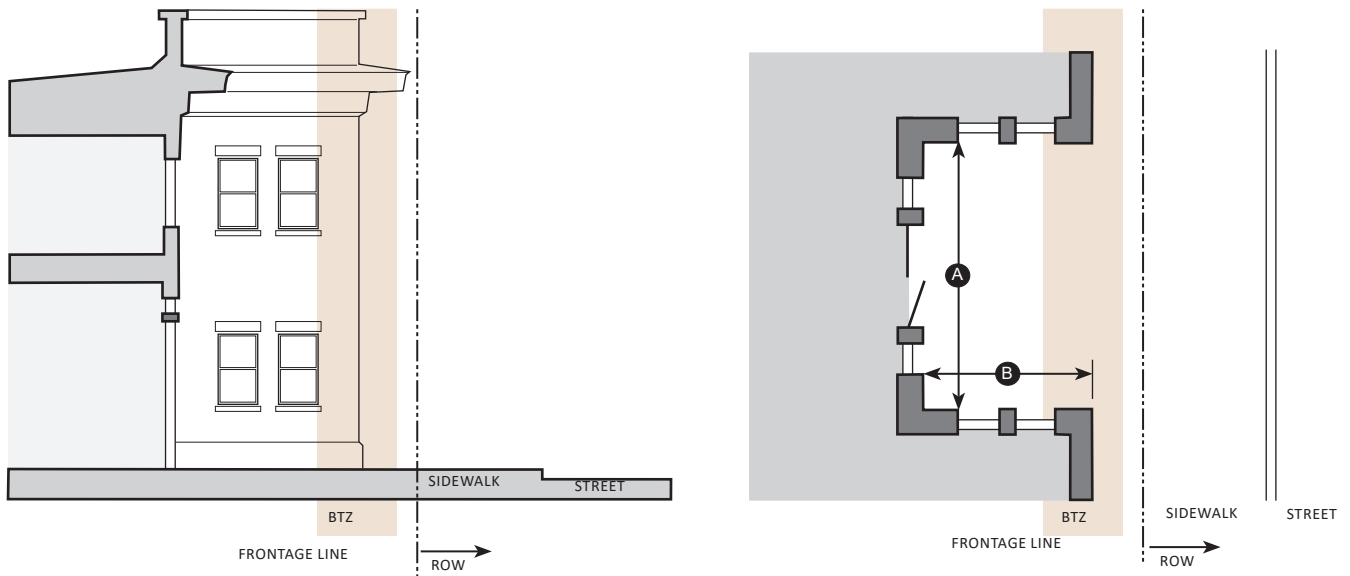

KEY

- FRONTAGE/PROPERTY LINE
- BTZ BUILD-TO-ZONE (BTZ)

#### A. DESCRIPTION

THE PRIMARY PORTION OF THE BUILDING'S FRONT FAÇADE IS AT THE BUILD-TO-ZONE WHILE A SMALL PERCENTAGE IS SET BACK, CREATING A COURTYARD SPACE. THIS SPACE CAN BE USED AS AN APARTMENT OR OFFICE ENTRY COURT, GARDEN SPACE, OR FOR OUTDOOR SEATING OR DINING.

#### B. SIZE

WIDTH, CLEAR	12' MIN.	A
DEPTH, CLEAR	12' MIN.	B

#### C. MISCELLANEOUS

FORECOURTS ARE ESPECIALLY USEFUL ALONG LARGER, MORE AUTO-DOMINANT THOROUGHFARES IN ORDER TO PROVIDE WELL-SHAPED, INTIMATELY SIZED PUBLIC OUTDOOR SPACES.



AN ELEVATED FORECOURT.



AN ELEVATED FORECOURT FORMING A DINING TERRACE.

### 4. Stoop

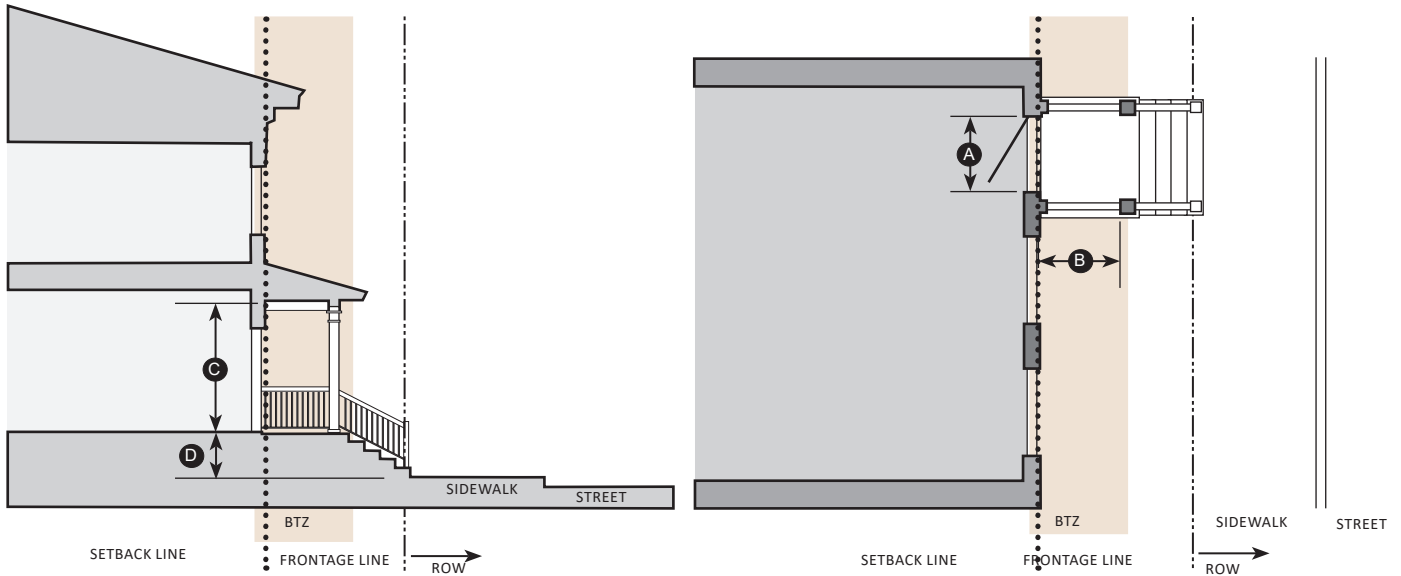

**KEY**  
 --- FRONTAGE/PROPERTY LINE      ..... SETBACK LINE  
 BUILD-TO-ZONE (BTZ)

#### A. DESCRIPTION

THE FRONT FAÇADE OF THE BUILDING IS AT THE BUILD-TO-ZONE OR SETBACK LINE AND THE ELEVATED STOOP PROJECTS FORWARD. THE STOOP IS USED TO ACCESS A FIRST FLOOR THAT IS ELEVATED ABOVE THE SIDEWALK TO ENSURE PRIVACY WITHIN THE BUILDING. STAIRS FROM THE STOOP SHALL DESCEND FORWARD OR TO THE SIDE. STOOPS SHALL EXTEND FORWARD OF THE BUILD-TO-ZONE OR SETBACK LINE AND, IF PERMITTED BY THE TRANSECT ZONE STANDARDS, INTO THE RIGHT-OF-WAY; A 6' MINIMUM CLEAR ZONE FOR PEDESTRIANS SHALL BE MAINTAINED ON THE SIDEWALK.

#### B. SIZE

WIDTH, CLEAR	5' MIN., 8' MAX.	<b>A</b>
DEPTH, CLEAR	5' MIN., 8' MAX.	<b>B</b>
HEIGHT, CLEAR	8' MIN.	<b>C</b>
HEIGHT	1 STORY MAX.	
FINISH LEVEL ABOVE SIDEWALK	24" MIN.	<b>D</b>

#### C. MISCELLANEOUS

STAIRS SHALL BE PERPENDICULAR OR PARALLEL TO THE BUILDING FAÇADE.



UNROOFED STOOPS



COVERED STOOPS

5. Porch

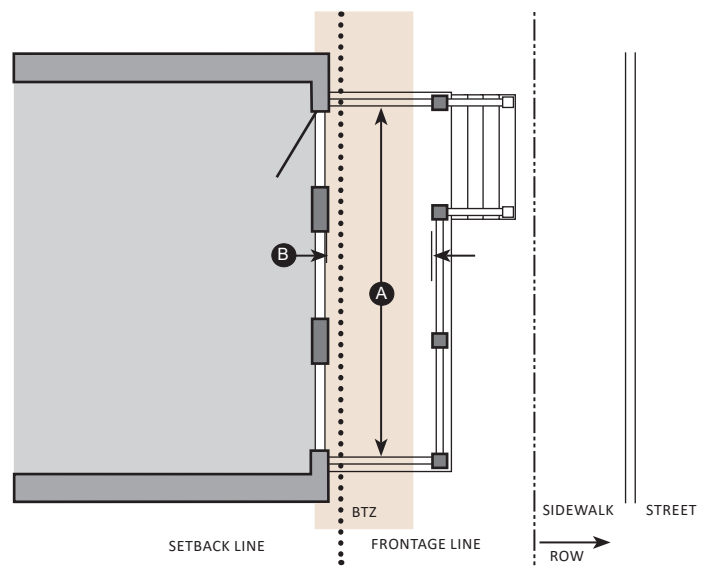
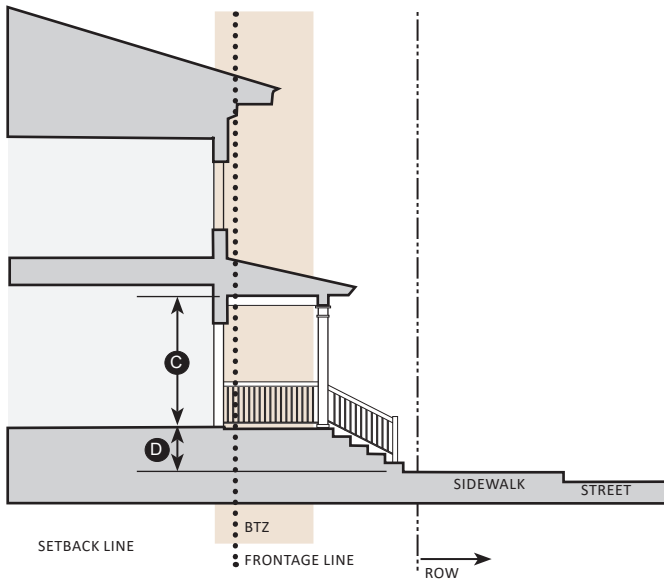

KEY

- FRONTAGE/PROPERTY LINE      ..... SETBACK LINE
- BUILD-TO-ZONE (BTZ)

**A. DESCRIPTION**

THE FRONT FAÇADE OF THE BUILDING IS AT THE BUILD-TO-ZONE OR SETBACK LINE AND THE PORCH PROJECTS FORWARD. THE PORCH IS USED TO ACCESS A FIRST FLOOR THAT IS ELEVATED ABOVE THE SIDEWALK TO ENSURE PRIVACY WITHIN THE BUILDING. A PORCH IS LARGE ENOUGH TO FUNCTION AS AN OUTDOOR LIVING SPACE. STAIRS FROM THE PORCH SHALL DESCEND FORWARD OR TO THE SIDE. PORCHES SHALL EXTEND FORWARD OF THE BUILD-TO-ZONE OR SETBACK LINE. STAIRS FROM THE PORCH SHALL EXTEND INTO THE RIGHT-OF-WAY IF PERMITTED BY THE TRANSECT ZONE STANDARDS; A 6' MINIMUM CLEAR ZONE FOR PEDESTRIANS SHALL BE MAINTAINED ON THE SIDEWALK.

**B. SIZE**

WIDTH, CLEAR	10' MIN.	(A)
DEPTH, CLEAR	8' MIN.	(B)
HEIGHT, CLEAR	8' MIN.	(C)
HEIGHT	2 STORIES MAX.	
FINISH LEVEL ABOVE SIDEWALK	24" MIN.	(D)



A 2-STORY PORCH ON AN APARTMENT BUILDING.



A WRAPAROUND PORCH LOCATED CLOSE TO THE SIDEWALK.



**6. Common Yard**

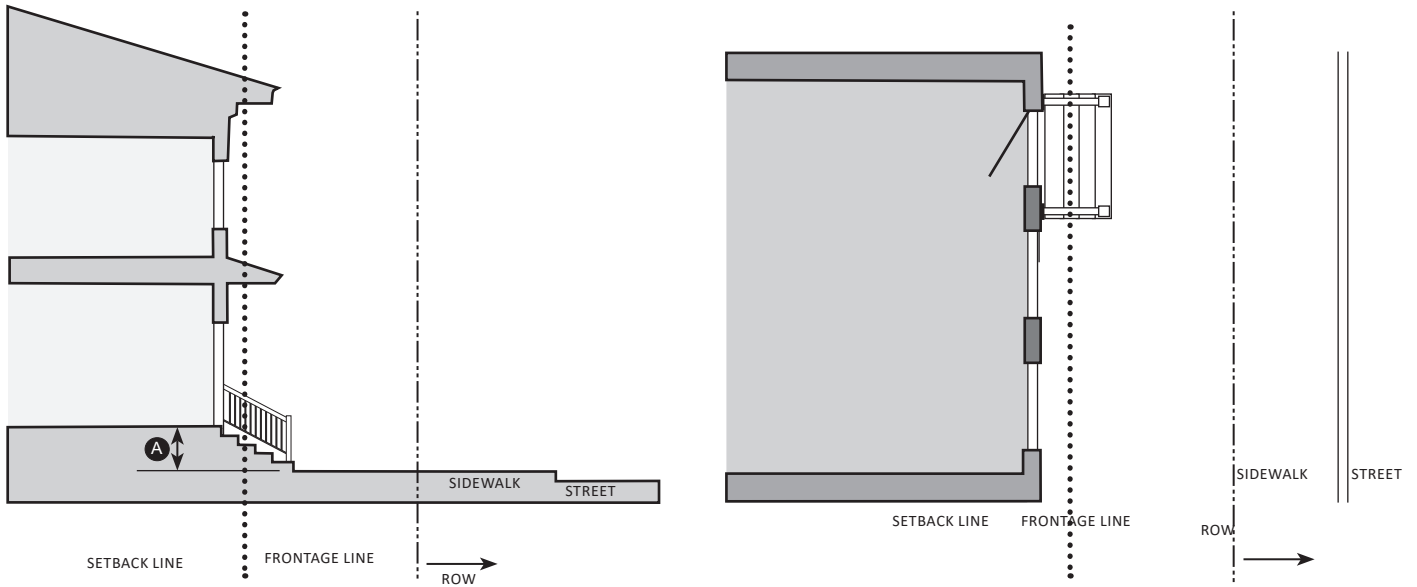

- KEY**
- FRONTAGE/PROPERTY LINE
  - ..... SETBACK LINE

**A. DESCRIPTION**

THE FRONT FAÇADE IS SET BACK SUBSTANTIALLY FROM THE FRONTAGE LINE WITH A PLANTED FRONTAGE. THE FRONT YARD CREATED REMAINS UNFENCED AND IS VISUALLY CONTINUOUS WITH ADJACENT YARDS, SUPPORTING A COMMON LANDSCAPE.

**B. SIZE**

FINISH LEVEL ABOVE SIDEWALK      24" MIN.      **A**



*PATHWAYS ACROSS THE COMMON YARDS CONNECT THE PRIMARY ENTRANCES TO THE SIDEWALK.*



*THE CONTIGUOUS OPEN SPACES PROVIDED BY THE COMMON YARD FRONTAGE CREATE A MORE PASTORAL SETTING.*

## Sec. 3.7 Site Standards

### Sec. 3.7.A. *Service Areas & Loading Docks*

Trash and recycling dumpsters or similar collection areas shall be located in the rear or to the side of buildings and screened from view from adjacent public Right-of-Ways, properties, and pedestrian walkways (not including Alleys).

### Sec. 3.7.B. *Mechanical Equipment*

For the purposes of these standards, mechanical equipment includes any heating, ventilation, and air conditioning (HVAC) or electrical machinery as well as air compressors, hoods, mechanical pumps, exterior water heaters, water softeners, utility and telephone company transformers, meter boxes, garbage cans, storage tanks, generators, ~~electric vehicle (EV) chargers,~~ geothermal wells, and similar elements.

1. If mechanical equipment is located at-grade, and is visible from an adjacent street or sidewalk, it shall be screened by a fence or Streetscreen.
2. All mechanical equipment or penthouse screening placed on a roof shall be set back from the roof line by a distance at least equivalent to the height of the screening in order to minimize visibility from surrounding streets.

### Sec. 3.7.C. *Privacy Fences*

A maximum of 6' in height is allowed in residential properties along the sides and rear yard property lines. Fences shall not be placed in the front yard or closer to the street than the façade line.



# DIVISION 4: THOROUGHFARE STANDARDS

## Purpose

The purpose of the Thoroughfare Standards is to provide regulations in creating an interconnected network of streets that can accommodate all modes of travel, including vehicular, pedestrian, and bicycle. The function of streets within the Horizon City TOD is to handle multimodal forms of traffic by providing a memorable experience by persons using the street network. The streets will work together with the trails network to provide multiple options for moving throughout the neighborhood and around Horizon City. The function of each street will guide the design in concert with its context. The context is determined by the character of its Transect Zone.

Typical street sections illustrating the key characteristics of each proposed new or improved street are provided in Sec. 4.11. The conditions illustrated in the typical street sections may be interrupted for intersections, bump-outs, central greens, or other traffic calming devices depending on the context details of the final neighborhood design.

## Street Hierarchy

On each parcel that has multiple street frontages (e.g., corner lots), the street hierarchy will determine the highest priority (Primary) street frontage, where the Front Build-to-Zone or Setback shall apply. Along the lower priority frontages, the Side (Secondary) Build-to -Zones or Setbacks shall apply. If both street frontages have the same priority, the Front Build-to-Zone or Setback shall apply along both corridors. The designated street hierarchy is as follows:

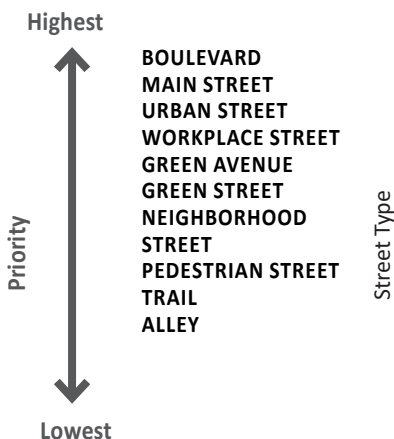

FIGURE 4-1: STREET HIERARCHY

## General Standards

The precise location and alignment of new streets may be adjusted to allow flexibility in the design of the site plan;

however, the intended purpose and network connectivity of each new street shall not be compromised. Proposed improvements to existing streets shall be permitted through The Town of Horizon City.

### Sec. 4.0.A. Street Design

The design of new streets and modifications to existing streets shall adhere to the following requirements:

1. Some dimensional flexibility is permitted for street types to account for varying Right-of-Way widths, however, they shall be designed to have all the basic functional characteristics including roadway width, on-street parking/Curbside Flex Zones, sidewalks, trails, street trees, and landscaped areas shown for their type, and be appropriately sized for the Transect Zones in which they are located.
2. New street types (with new sections) shall be permitted with approval by the City.
3. Each Neighborhood shall demonstrate appropriate provision for street connectivity and integration with adjoining neighborhoods. Connections to future development is required. When a Site Plan, consisting of one or more neighborhoods, is submitted for approval, the street network contained in those neighborhoods should connect to stub-outs of adjacent neighborhoods or other rights-of-way that form the edge of the neighborhood(s).
4. All non-pedestrian only Streets shall accommodate two-way traffic with the exception of streets adjacent to squares and plazas and Alleys, which may have 1 travel lane with one-way traffic.
5. All Streets shall connect to other Streets, no dead ends or cul-de-sacs shall be permitted.
6. Curbside Flex Zones replace the traditional on-street parking lanes with zones for a variety of uses, depending on the adjacent Transect Zone, on the following Street Types: Urban Streets, Workplace Streets, and Main Street. The zones can vary along the length of the curb and/or throughout the time of day or year. Flex zones may include: parking, transit stops, rideshare passenger pick-up/drop-off, delivery, vendors, and shared-mobility stations.
7. Where possible, there should be parking lanes/ Curbside Flex Zones on one or both sides of a Street, depending on need.
8. On-street parking lanes/ Curbside Flex Zones shall not be closer than 25 feet to intersections measured from the curb line.
9. All sidewalks and paths shall be unobstructed by

utility poles, fire hydrants, benches, street signs, or any other temporary or permanent structures.

10. Paving specifications shall adhere to the Town of Horizon City's requirements.

**Sec. 4.0.B. Curb Radius**

Several walkability benefits can be gained by decreasing the radius of curbs at intersections. These benefits include the following: decreased crossing distances for pedestrians, greater visibility of pedestrians by motorists, and traffic calming, enhancing safety for pedestrians. Corner curb radius designs fall into two distinct categories: corners with and without on-street parking.

1. Corners with on-street parking shall have curb radii of 15 feet maximum. The effective turning radius is larger than the curb radius when parking is present. Thus, the effective turning radius can be 30 plus feet when the curb radius is 15 feet.
2. Corners without on-street parking require the curb radii to be similar to the turning radii, with the curb radius between 20 feet and 30 feet maximum.
3. Curb radii may be smaller, 9 feet to 15 feet, for Alleys.

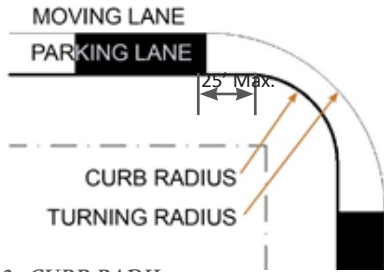

FIGURE 4-2: CURB RADII

**Sec. 4.0.C. Intersection Design / Size**

While intersection design shall accommodate larger vehicles, the safety of pedestrians and bicyclists shall be the highest priority.

1. The majority of intersecting streets shall meet at approximately a 90-degree angle. Angles of intersection less than 60 degrees should be avoided.
2. Offset intersections in close proximity to one another (220' for Urban Street Types, 150' for other Street Types) are prohibited.
3. The use of auxiliary turn lanes at intersections for traffic movement shall be carefully weighed against the impact to pedestrian and cyclist movement at the intersection, and the use of such lanes shall not be determined by traffic analysis alone. The final decision on whether an auxiliary turn lane is required shall be made by the City Engineer with agreement from the

4. Pedestrian and bike crossing infrastructure shall be provided across all intersection approaches, including high visibility crosswalks, sidewalk ramps, and detectable warnings.
5. To the extent possible, pedestrian exposure to vehicles and crossing distances shall be reduced through the use of refuge islands, bump outs, and pedestrian signals.

**4.0.D. Alleys**

~~A continuous network of Alleys is desirable to serve as the primary means of vehicular ingress to individual lots. Such networks are mandatory in the T5 and T4 Transect Zones.~~

1. ~~Alley entrances should align so as to provide ease of ingress for service vehicles.~~
2. ~~Alley entrances shall not face Civic Open Spaces or Civic Buildings.~~
3. ~~Alleys should meet streets with a mountable gutter pan, allowing the sidewalk to continue uninterrupted across the Alley pavement. The use of curb cuts, ramps, and marked crosswalks should be avoided for Alleys.~~

**Street Lighting**

**Sec. 4.0.E. General Street Lighting Standards**

1. All street lighting shall comply with the standards established in Sec. 5.4 Lighting Standards.
2. A combination of pedestrian-scaled street light fixtures and intersection street light fixtures may be required to ensure a well-lit street and to establish a unifying element along the street. Pedestrian-scaled fixtures shall be used on all streets, except Alleys. Intersection-scaled lighting may be used in addition to pedestrian-scaled lights where necessary.
3. Street lights shall be aligned with street tree placement (generally between 2.5 feet and 4 feet from the back of the curb). Placement of fixtures shall be coordinated with the organization of sidewalks, landscaping, street trees, building entries, curb cuts, signage, etc.
4. The height of light fixtures shall be kept low (generally not taller than 15 feet) to promote a pedestrian scale to the Public Realm and to minimize light spill to adjoining properties. Light fixtures shall be closely spaced (generally not more than fifty (50) feet on center) in T4 and T5 Zones and eighty (80) feet in the T3 Zone to provide appropriate levels of illumination.
5. Light poles may include armature that allows for the hanging of banners or other amenities (e.g., hanging flower baskets, artwork, etc.).

6. All street lighting fixtures shall be full cutoff.

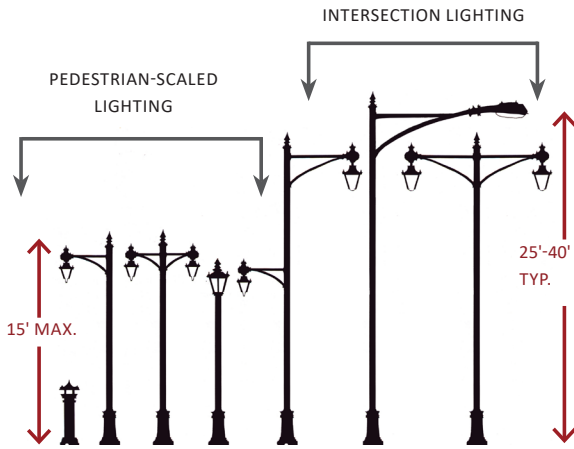

FIGURE 4-3: STREET LIGHTING

**Sec. 4.0.F. Lighting Types And Configurations**

1. The configuration of street lighting fixtures shall be appropriately chosen for the Transect Zone within which they are located as outlined in the table below. Flexibility shall be permitted to vary from strict compliance with this table to achieve logical uniformity of fixtures within a given thoroughfare segment or Public Realm.
2. The City shall set a lighting pole and fixture standard for use throughout the Horizon City TOD prior to the approval of the first Site Plan for aesthetic conformity and maintenance inventory.

**Street Trees**

1. All street trees shall comply with the General Landscape Standards in Division 6.
2. Street trees shall consist of shade trees with a minimum 3-inch caliper at time of planting. Other accent plants and trees are permitted in addition to the required street trees.
3. Street trees shall be provided in a manner and at a spacing as defined by the Street Type standards.
4. Street trees shall be planted in vegetated Planting Strips or Tree Wells with grates according to Street Types.
5. Properly designed tree box filters to accept stormwater runoff are necessary for stormwater quantity and quality mitigation, and shall count towards the street tree requirement as long as adequate maintenance access is provided and the street tree planted meets the requirements of this standard. See the National Association of Transportation Officials (NACTO) *Urban Street Stormwater Guide* and the *Light Imprint Handbook* for more information.

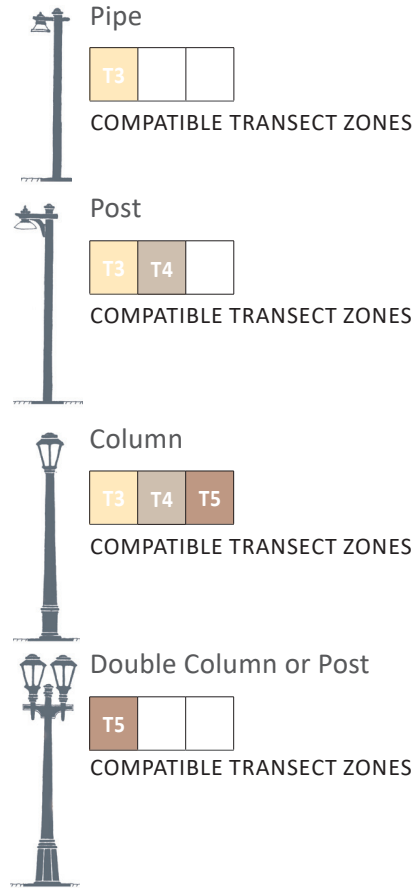

FIGURE 4-4: STREET LIGHTING

**Transit Shelters**

Transit shelters should be of the same style, materials, and color as the typical other transit shelter used throughout Horizon City. Shelters should be scaled appropriately for the level of ridership anticipated at a particular stop.

**Sidewalks and Pavement**

A continuous system of sidewalks should be provided along both sides of all streets within Horizon City. All sidewalks should be separated from the travel way of the street by a planting zone of 5'-0" to 8'-0" in width, with trees planted at intervals of 30 to 40 feet. Sidewalk dimensions and configurations on Horizon City's hierarchical roadway system are illustrated in the Street Plan section. The use of light-colored concrete is required on streets to help mitigate heat island effect.

**Site Furniture**

Site furnishings have the potential to impact and enhance user experience and comfort. Developers should provide furnishings complementary to site design in convenient and appropriate locations as approved by the City. Seating, trash receptacles, transit shelters, and other furnishings are all significant elements that contribute to the character and amenity of the public environment, including the streets

and parks within the Horizon City community. There may be opportunities for site furnishings to be considered as public art installations. Benches, trash and recycling receptacles will be incorporated along sidewalks and at transit stops for greater pedestrian comfort and convenience. Site Furnishings should be coordinated with and approved by the City.

## Thoroughfare Construction Standards

Construction shall adhere to the Town of Horizon City's standard details for road & site construction and public facilities.

## Street Network

### Sec. 4.0.G. *Protected Bike Lanes and Shared Use Paths*

A network of protected bike lanes and shared use paths shall be incorporated in development along designated bike network, if present, in the City's bike master plan.



# Street Types

## Sec. 4.0.H. Urban Street Sections

Urban street types are intended for T4 and T5 zones to allow more on-street parking for commercial and offices. The Main Street types are for areas with more ground floor retail and restaurants requiring wider sidewalks.

### 1. Main Street - Dilley & Delake

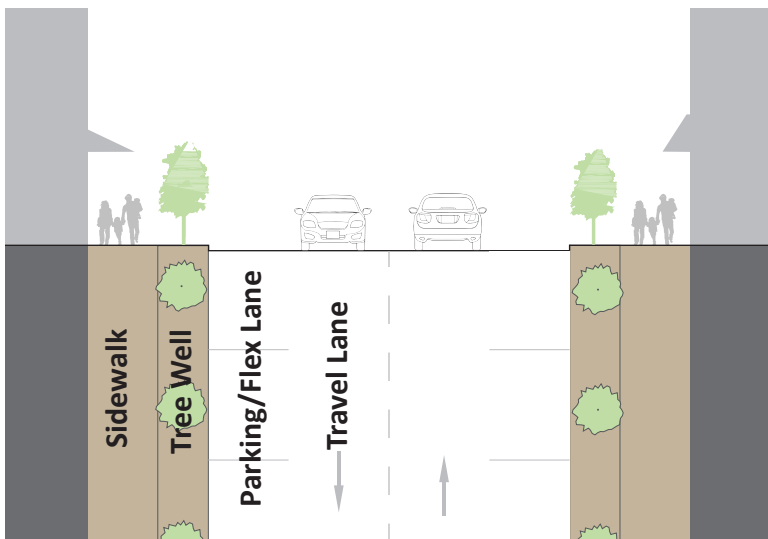

TYPE	MAIN STREET
TRANSECT	T5, T4
TRAVEL LANES	TWO LANES - 10 FEET WIDE
PARKING LANES/ CURBSIDE FLEX ZONE	TWO SIDES @ 8 FEET MARKED
BIKE FACILITY	NONE
R.O.W. WIDTH	60 FEET
PAVEMENT WIDTH	36 FEET
VEHICULAR DESIGN SPEED	20 MPH
SIDEWALK WIDTH	12 FEET
ROAD EDGE TREATMENT	CURB
PLANTER WIDTH	5 FOOT X 5 FOOT TREE WELLS
PLANTING	SHADE TREES @ 30' O.C. AVG

### 2. Curbless Main Street - Dilley and Delake

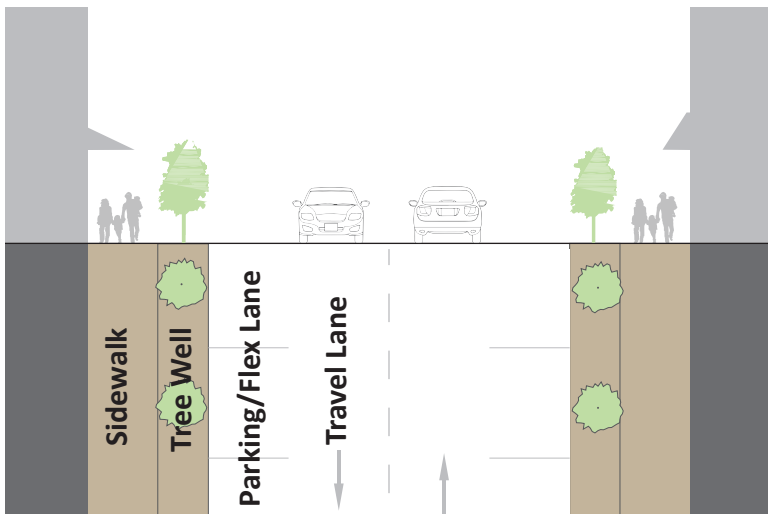

TYPE	CURBLESS MAIN STREET
TRANSECT	T5, T4
TRAVEL LANES	TWO LANES - 10 FEET WIDE
PARKING LANES/ CURBSIDE FLEX ZONE	TWO SIDES @ 8 FEET MARKED
BIKE FACILITY	NONE
R.O.W. WIDTH	60 FEET
PAVEMENT WIDTH	36 FEET
VEHICULAR DESIGN SPEED	20 MPH
SIDEWALK WIDTH	12 FEET
ROAD EDGE TREATMENT	CURBLESS
PLANTER WIDTH	5 FOOT X 5 FOOT TREE WELLS
PLANTING	SHADE TREES @ 30' O.C. AVG



3. Urban Street

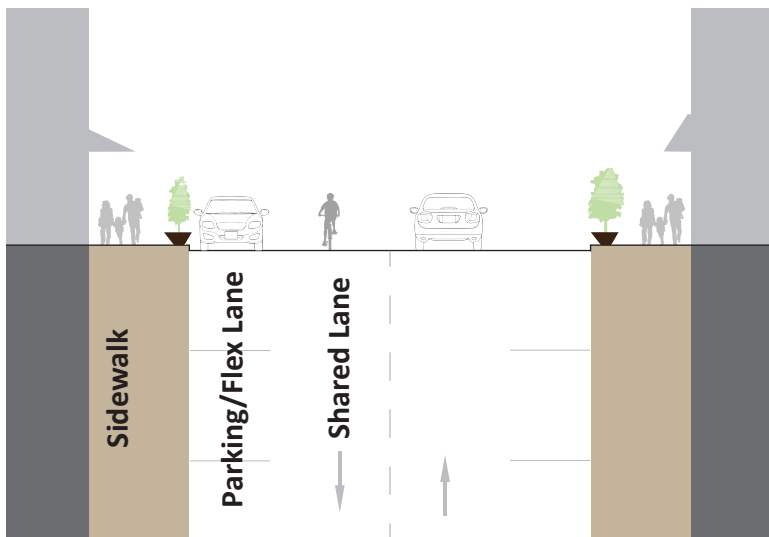

The Urban Street designation applies to streets:

- Benton,
- Fallon,
- Emmigrant, and
- Rossman

TYPE	URBAN STREET
TRANSECT	T5, T4
TRAVEL LANES	TWO LANES - 11 FEET WIDE
PARKING LANES/ CURBSIDE FLEX ZONE	TWO SIDES @ 8 FEET MARKED
BIKE FACILITY	SHARROW
R.O.W. WIDTH	60 FEET
PAVEMENT WIDTH	38 FEET
VEHICULAR DESIGN SPEED	20 MPH
SIDEWALK WIDTH	11 FEET
ROAD EDGE TREATMENT	CURB
PLANTERS	PLANTERS OR TREE WELL OF 5' X 5'
PLANTING	SHADE TREES @ 30' O.C. AVG

**Sec. 4.0.I. Neighborhood Street Sections**

Neighborhood street types are narrower to slow auto traffic in T3 and T4 zones which need less on-street parking. A variety of narrow streets can be applied to allow for different levels of enclosure from building walls and tree canopies, providing more shade and a more pleasant walk.

The Neighborhood Street designation applies to streets:

- Cross River,
- Kingston,
- Etheridge,
- Fernhill,
- Highweed,
- Oroville, and
- Gearhart

**1. General Street**

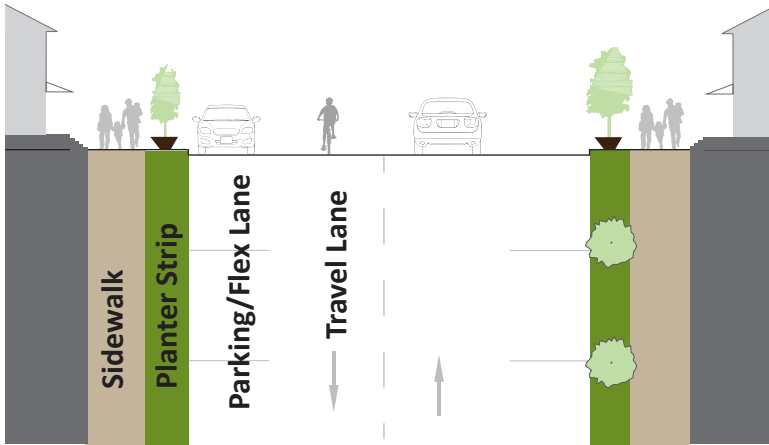

TYPE	GENERAL STREET
TRANSECT	T4, T3
TRAVEL LANES	TWO LANES - 10 FEET WIDE
PARKING LANES	TWO SIDES @ 8 FEET
BIKE FACILITY	IN THE DRIVE LANE
R.O.W. WIDTH	60 FEET
PAVEMENT WIDTH	36 FEET
VEHICULAR DESIGN SPEED	20 MPH
SIDEWALK WIDTH	7 FEET
ROAD EDGE TREATMENT	CURB OR SWALE
PLANTER WIDTH	5 FOOT PLANTER STRIPS
PLANTING	SHADE TREES @ 30' O.C. AVG

**2. Yield Street**

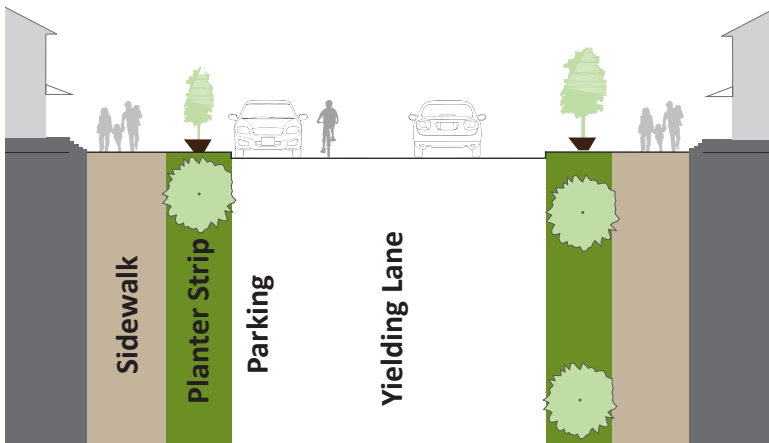

TYPE	YIELD STREET
TRANSECT	T4, T3
TRAVEL LANES	SHARED 24 FEET PAVED - TWO-WAY TRAFFIC
PARKING LANES	ONE SIDE UNMARKED
BIKE FACILITY	SHARED LANE
R.O.W. WIDTH	46 FEET MINIMUM
PAVEMENT WIDTH	24 FEET
VEHICULAR DESIGN SPEED	20 MPH
SIDEWALK WIDTH	6 FEET
ROAD EDGE TREATMENT	CURB OR SWALE
PLANTER WIDTH	5 FOOT PLANTER STRIPS
PLANTING	SHADE TREES @ 30' O.C. AVG

3. ~~Narrow Street~~

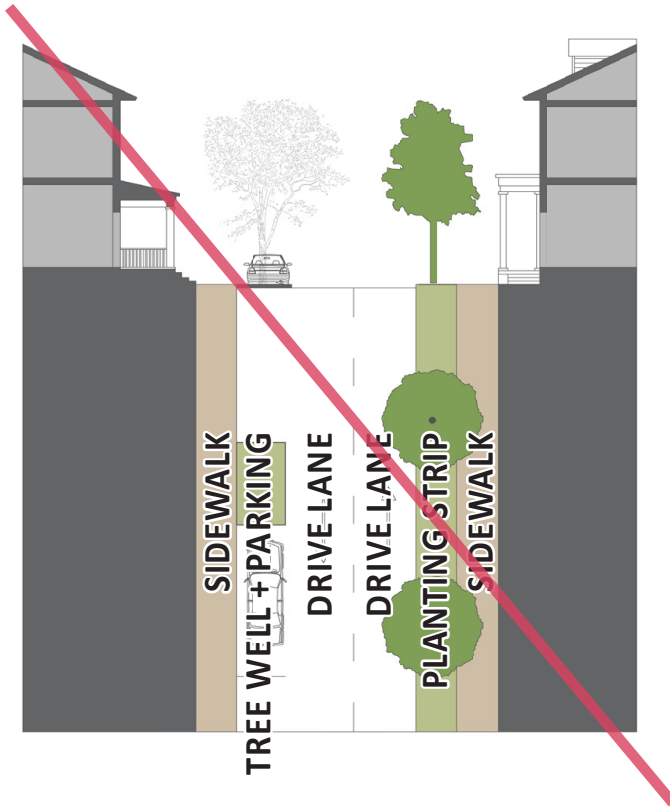

TYPE	NARROW STREET
TRANSECT	T4, T3
TRAVEL LANES	TWO LANES - 9 FEET WIDE
PARKING LANES	ONE SIDE @ 8 FEET
BIKE FACILITY	IN THE DRIVE LANE
R.O.W. WIDTH	42 FEET MINIMUM
PAVEMENT WIDTH	26 FEET
VEHICULAR DESIGN SPEED	20 MPH
SIDEWALK WIDTH	6 FEET
ROAD EDGE TREATMENT	CURB OR SWALE
PLANTER WIDTH	5 FOOT PLANTER STRIPS ONE SIDE TREE WELL IN PARKING LANE ONE SIDE
PLANTING	SHADE TREES @ 30' O.C. AVG

**Sec. 4.0.J. Green Street Sections**

The Green Avenue streets provide premium bike facilities and are the main facilities to create the primary bike network throughout the Horizon City community.

**1. Central Green Avenue**

The Green Avenue  type acts as a major people-mover with separate ~~vs~~ shared-use path in the center of the street for pedestrians and cyclists.

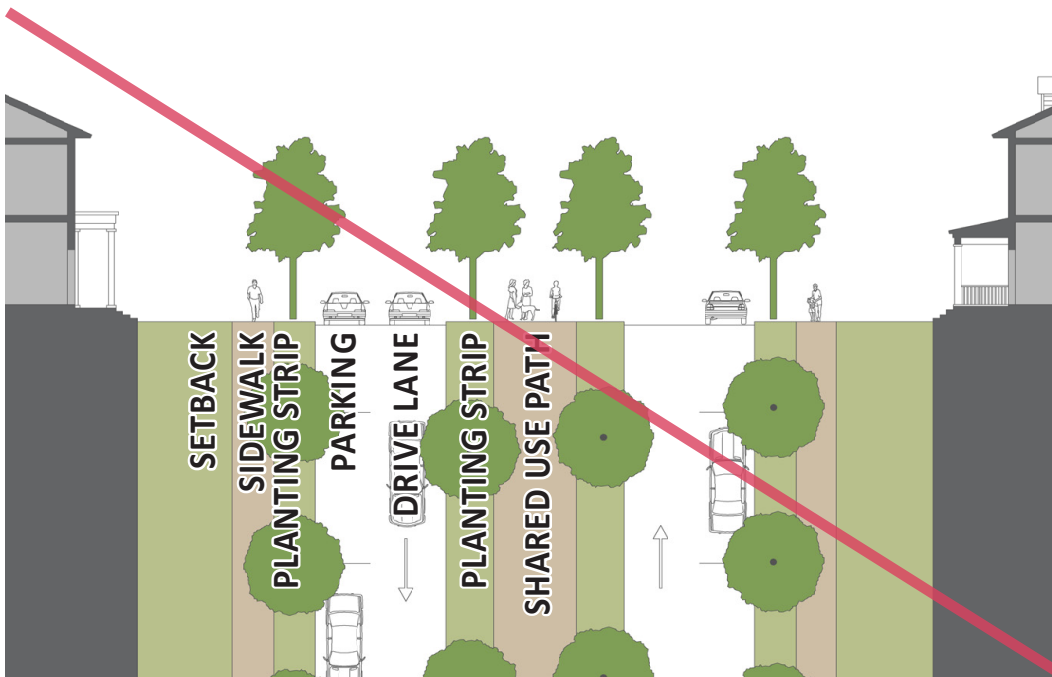

TYPE	GREEN AVENUE
TRANSECT	T4, T3
TRAVEL LANES	TWO LANES @ 12 FEET WIDE
PARKING LANES	EACH SIDE @ 8 FEET
BIKE FACILITY	CENTRAL SHARED USE PATH @ 10-12 FEET
R.O.W. WIDTH	80 FEET MINIMUM
PAVEMENT WIDTH	20 FEET & 20 FEET
VEHICULAR DESIGN SPEED	25 MPH
SIDEWALK WIDTH	6 FEET
ROAD EDGE TREATMENT	CURB OR SWALE
PLANTER WIDTH	6 FOOT PLANTER STRIPS CENTRAL MEDIAN
PLANTING	SHADE TREES @ 30' O.C. AVG

**2. Bikeway in Urban Environment**

The bikeway with cycle track allows for faster moving bike traffic separate from both pedestrians and auto traffic. The cycle track can vary according to land use or desired street width.

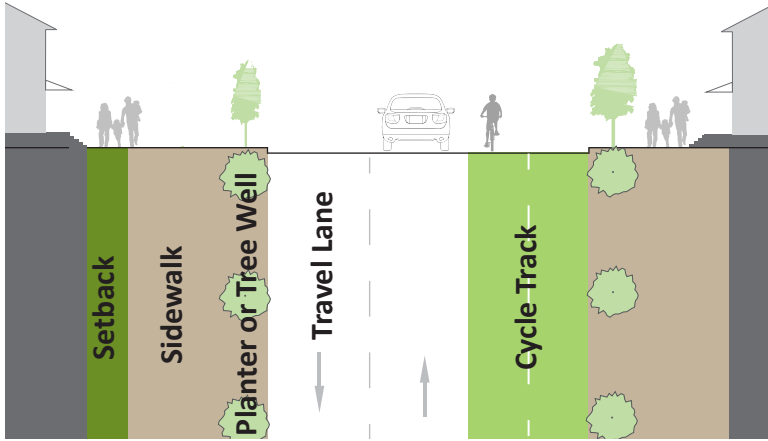

TYPE	BIKEWAY WITH CYCLE TRACK
TRANSECT	T5, T4
TRAVEL LANES	TWO LANES - 10 FEET WIDE
PARKING LANES	NONE
BIKE FACILITY	TWO-WAY CYCLE TRACK - 12 FEET MINIMUM
R.O.W. WIDTH	60 FEET MINIMUM
PAVEMENT WIDTH	20 FEET
VEHICULAR DESIGN SPEED	25 MPH
SIDEWALK WIDTH	14 FEET
ROAD EDGE TREATMENT	CURB
PLANTER WIDTH	PLANTER OR TREE WELL
PLANTING	SHADE TREES @ 30' O.C. AVG

**3. Two-way Bikeway in Urban Environment**

The two-way bikeway also allows for faster moving bike traffic separate from both pedestrians and auto traffic. The two-way bikeway can vary according to land use or desired street width.

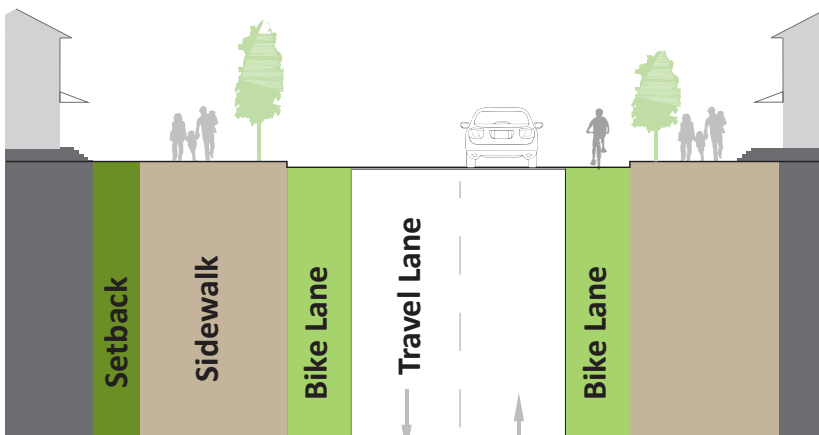

TYPE	TWO-WAY BIKEWAY
TRANSECT	T5
TRAVEL LANES	TWO LANES - 10 FEET WIDE
PARKING LANES	NONE
BIKE FACILITY	PROTECTED BIKE LANE EACH SIDE - 6 FEET
R.O.W. WIDTH	32' FEET MINIMUM
PAVEMENT WIDTH	20 FEET
VEHICULAR DESIGN SPEED	20 MPH
SIDEWALK WIDTH	14 FEET
ROAD EDGE TREATMENT	CURB
PLANTER WIDTH	NONE ; TREE WELL
PLANTING	SHADE TREES @ 30' O.C. AVG

Sec. 4.0.K. **Street Sections**

Trail streets have a wider shared-use path on one side in place of a sidewalk, allowing a larger flow of shared pedestrian and bike traffic.

**1. Trail Street**

Trail streets are the General Street with a wider shared-use path replacing one of the sidewalks.

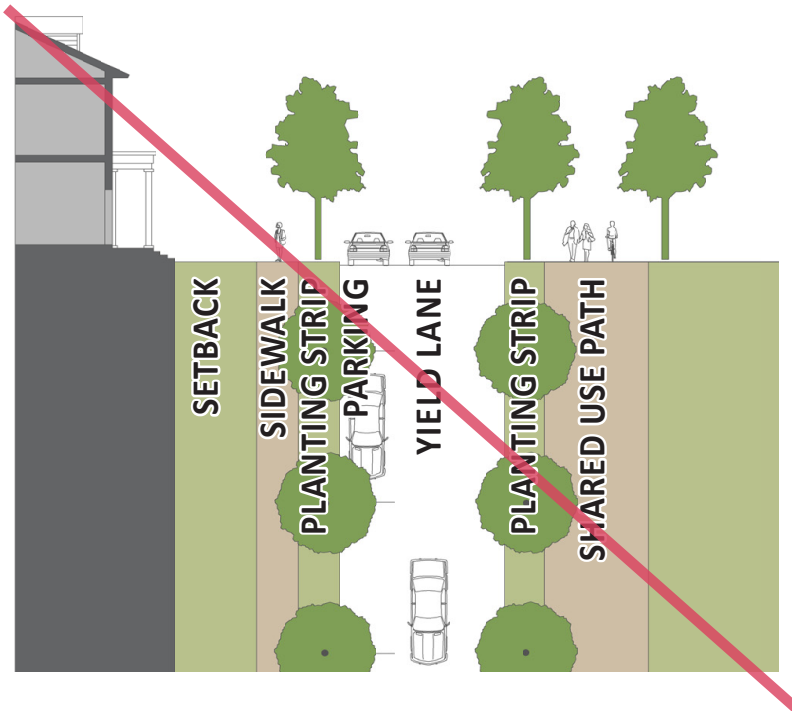

TYPE	TRAIL STREET
TRANSECT	T5, T4, T3
TRAVEL LANES	SHARED 24 FEET PAVED - TWO-WAY TRAFFIC
PARKING LANES	ONE SIDE UNMARKED
BIKE FACILITY	SHARED USE PATH - 12 FEET MIN.
R.O.W. WIDTH	52 FEET MIN.
PAVEMENT WIDTH	24 FEET
VEHICULAR DESIGN SPEED	20 MPH
SIDEWALK WIDTH	6 FEET ONE SIDE
ROAD EDGE TREATMENT	CURB OR SWALE
PLANTER WIDTH	5 FOOT PLANTER STRIPS
PLANTING	SHADE TREES @ 30' O.C. AVG



**Sec. 4.0.L. Pedestrian Street Sections**

Pedestrian streets are intended primarily for pedestrian use only, with occasional use by cyclists.

**1. Urban Pedestrian Street**

The urban pedestrian street can be used in the retail areas of T5 zones to allow people to flow seamlessly between shops and restaurants without interacting with auto traffic.

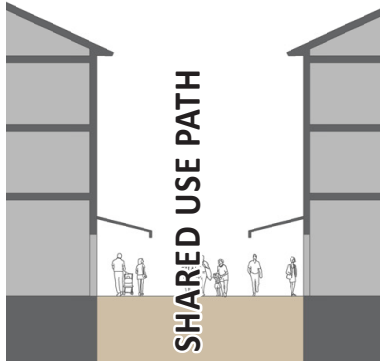

TYPE	URBAN PEDESTRIAN STREET
TRANSECT	T5, T4
BIKE FACILITY	SHARED
R.O.W. WIDTH	30 FEET MINIMUM
SIDEWALK WIDTH	20 FEET SHARED PATH
PLANTER WIDTH	OCCASIONAL PLANTINGS IN TREE WELLS

**2. Neighborhood Pedestrian Street**

The neighborhood pedestrian street is intended as mid-block crossing between houses to allow pedestrians a short cut to parks or other destinations.

**1. Green Pedestrian Street**

The Green Pedestrian Street is a variation on the Neighborhood type with a center green space that



TYPE	NEIGHBORHOOD PEDESTRIAN STREET
TRANSECT	T5, T4, T3
BIKE FACILITY	SHARED
R.O.W. WIDTH	20 FEET MINIMUM
SIDEWALK WIDTH	10 FEET MINIMUM SHARED PATH
PLANTER WIDTH	5 FEET PLANTING STRIPS

can vary in width from a small planting strip to a pocket park.

**2. Pedestrian Bridge**

The pedestrian bridge is intended as mid-block canal crossing to shorten walking distance and provide more pedestrian access across the Grand Canals.



TYPE	NEIGHBORHOOD PEDESTRIAN STREET
TRANSECT	T4, T3
BIKE FACILITY	SHARED
R.O.W. WIDTH	40 FEET MINIMUM
SIDEWALK WIDTH	6 FEET MINIMUM EACH SIDE
	30 FEET MINIMUM GREEN SPACE

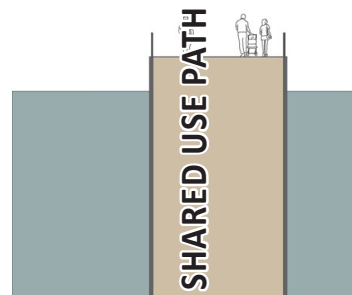

TYPE	PEDESTRIAN BRIDGE
TRANSECT	T5, T4, T3
BIKE FACILITY	SHARED
R.O.W. WIDTH	12 FEET MINIMUM
SIDEWALK WIDTH	12 FEET MINIMUM
PLANTER WIDTH	N/A

**Sec. 4.0.M. Alley Sections**

Alleys are located mid-block and allow access to mid-block parking areas, trash, collection, utilities, and rear loading zones.

**1. Commercial Alley**

A commercial alley is located in T5 providing enough room for delivery trucks and temporary loading and unloading while allowing vehicles to move around them. Alleys provide rear access to shared parking, parking garages, or loading docks at the back of mixed-use developments in the downtown and main street districts.

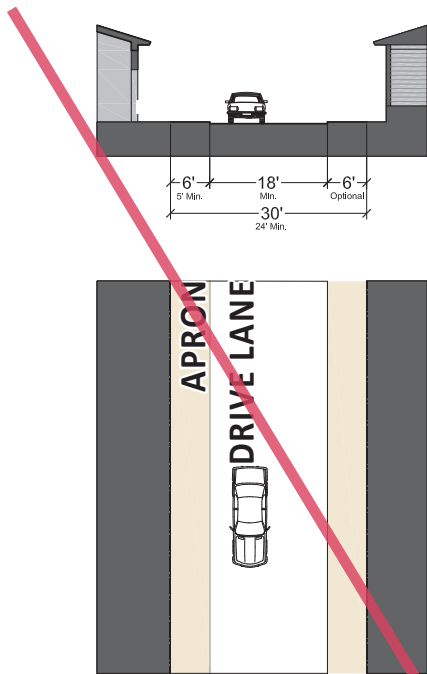

**2. Residential Alley**

A residential alley has a single yield lane with room for cars backing out of garages. This street type allows rear-loaded housing to reduce curb cuts in front and reduce opportunities for auto-pedestrian collisions, creating a safer sidewalk. Alleys allow narrow lot homes to face the street and be within conversation distance of the sidewalk instead of being dominated by vehicles and garage doors.

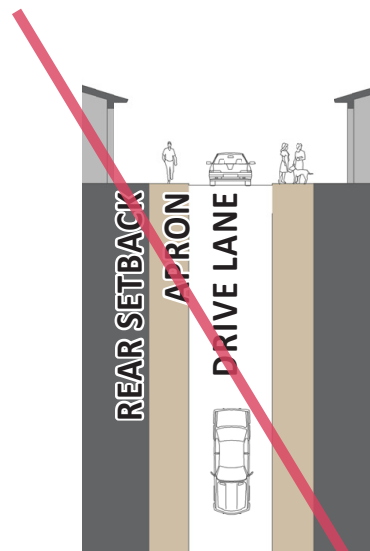

TYPE	ALLEY - NON-RESIDENTIAL
TRANSECT	T5
TRAFFIC LANES	TWO-WAY TRAFFIC - 12 FEET LANES
PARKING LANES	N/A
BIKE FACILITY	NONE
R.O.W. WIDTH	24 FEET
PAVEMENT WIDTH	24 FEET
VEHICULAR DESIGN SPEED	5 MPH
SIDEWALK WIDTH	NONE
ROAD EDGE TREATMENT	VARIES
PLANTER WIDTH	N/A
PLANTING	N/A

TYPE	ALLEY - RESIDENTIAL
TRANSECT	T5, T4, T3
TRAFFIC LANES	YIELD LANE - 12 - 14 FEET
PARKING LANES	N/A
BIKE FACILITY	NONE
R.O.W. WIDTH	20 FEET MIN.
PAVEMENT WIDTH	12 TO 18 FEET
VEHICULAR DESIGN SPEED	5 MPH
SIDEWALK WIDTH	NONE
ROAD EDGE TREATMENT	VARIES
PLANTER WIDTH	N/A
PLANTING	N/A

# DIVISION 5: SITE DEVELOPMENT STANDARDS

## Sec. 5.1 Purpose

These general standards apply to all Transect Zones, unless otherwise noted, specifying standards that impact walkability and the quality of the Public Realm as well as parking requirements and the design of signage, lighting, landscaping, and utilities.

## Sec. 5.2 Parking Standards

The intent of the parking standards is to encourage a balance between pedestrian-oriented development and necessary vehicle storage. The goal is to construct neither more nor less parking than is needed.

### Sec. 5.2.A. Parking Requirements

1. Parking shall be provided for each use based upon the minimum and maximum requirements outlined by use in Table 5-1: Automobile Parking Requirement Chart. Required parking quantities for a parcel shall be modified by Warrant.

USE	NUMBER OF PARKING SPACES			
	T3 <sup>2</sup>	T4 <sup>2</sup>	T5 <sup>1</sup>	C <sup>2</sup>
RESIDENTIAL	2 / UNIT	1 / UNIT	2 / UNIT	---
LODGING	1 / GUEST ROOM			
OFFICE	2 / 1,000 SQ. FT.			
RETAIL	3 / 1,000 SQ. FT.			
CIVIC	TBD BY WARRANT			
EDUCATION	1 PER 12 STUDENTS			
OTHER: GENERAL	TBD BY WARRANT			
OTHER: INDUSTRIAL	1 PER EMPLOYEE ON LARGEST SHIFT			

<sup>1</sup>MAXIMUM NUMBER OF SPACES PERMITTED

<sup>2</sup>MINIMUM NUMBER OF SPACES REQUIRED

2. Parking shall be located on the same lot as the use it serves. Required parking can also be located on-street or in a common parking lot, provided the space is within 1/4 mile of the building's Principal Entrance.
3. Parking shall be located behind the Principal Façade of buildings to the maximum extent possible. Parking lots shall be masked from the frontage by a liner building, streetscreens, garden walls, fences, or hedges are required along all rights-of-way without buildings to shield views to parking.
4. Shared and Reduced Parking is encouraged in all Transect Zones for more efficient parking

solutions. The amount of parking required is calculated by adding the total number of spaces required by each separate function in the Parking Requirement Chart and dividing by the appropriate factor from the Sharing Factor matrix. See Table 5-2. For example, the residential function requires ten spaces while the office function requires twelve spaces. Independently they would require twenty-two spaces, but when divided by the sharing factor of 1.4, they would require only sixteen spaces. When multiple functions share parking, the lowest sharing factor shall apply.

FUNCTION	WITH	FUNCTION
RESIDENTIAL		RESIDENTIAL
LODGING		LODGING
OFFICE		OFFICE
RETAIL		RETAIL

5. Bicycle parking shall be provided in all Transect Zones per Table 5-3: Bicycle Parking Requirement Chart and subject to the two subsections below:
  - (a) Anchors: All spaces provided shall include a metal anchor sufficient to secure the bicycle frame when used in conjunction with a user-supplied lock.
  - (b) Location: Bicycle parking shall be located in a secure area covered from weather and shall be located as close to a building entrance as the closest on-site automobile parking space.

USE	MIN. NUMBER OF SPACES
RESIDENTIAL (BUILDINGS WITH 4 OR MORE UNITS)	2 SPACES OR 1 SPACE FOR EVERY 5 UNITS, WHICHEVER IS GREATER
NON-RESIDENTIAL	2 SPACES OR 1 SPACE FOR EVERY 2,500 SQ. FT., WHICHEVER IS GREATER

### Sec. 5.2.B. Parking Access

~~Alleys, where proposed, shall be the primary source of access to off-street parking. Parking along Alleys shall be perpendicular, diagonal, or parallel. Alleys shall be incorporated into parking lots as standard drive aisles. Access between parking lots across property lines is also encouraged.~~

1. Corner lots that have both rear and side access shall access parking through the rear. If no rear access exists, access to on-lot parking shall be provided from the side street.
2. If no Alley or side street exists, then efforts should be made to demonstrate an attempt to gain access across neighboring properties.
3. When access to rear parking must be accessed directly from the Primary Frontage, driveways shall be located along the sides of the property lines and designed such that pedestrians crossing on sidewalks always have the right of way.
4. Circular drives are prohibited except for Civic Buildings.

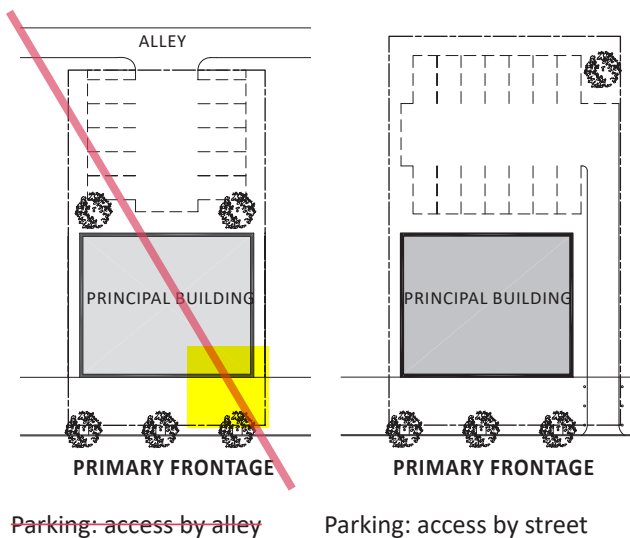

FIGURE 5-1: PARKING ACCESS

### Sec. 5.2.C. Off-street Surface Parking

1. Minimum setbacks for off-street surface parking from all property lines are provided in the Transect Zone Standards.

### Sec. 5.2.D. Garden Walls, Fences, and Hedges

Garden walls, fences, or hedges shall be located along Frontage Lines and other Lot Lines, or parallel with the Façades of buildings. When located along Frontage Lines, garden walls, fences, and hedges are called Streetscreens. Streetscreens shall mask a parking lot from the Thoroughfare, provide privacy to a side yard, and/or strengthen the spatial definition of the Public Realm.

1. Streetscreens shall be a minimum of 3 feet tall in all Transect Zones. Maximum heights shall be:
  - (a) T3 & T4: 4 feet along Primary Frontage and up to the BTZ, 6 feet along other Frontages
  - (b) T5: 4 feet along all Frontages
2. All Streetscreens over 4 feet high should be a minimum of 25% permeable or articulated.

3. Streetscreens shall be non-permeable by warrant.
4. Streetscreens shall have openings no larger than necessary to allow automobile and pedestrian access.
5. Streetscreens shall not be permitted in the Right-of-Way.
6. If a hedge is used, plants must be evergreen.

## Sec. 5.3 Signage Standards

### Sec. 5.3.A. Wayfinding Signs

1. Signs in the Public Realm shall enhance the character of the Public Realm, provide orientation to pedestrians and motorists, and help to give identity to the street. Signs should be designed and scaled for use by the pedestrian.
2. Signage should be coordinated with other streetscape furniture (e.g., light posts) to reduce visual clutter in the Public Realm.
3. Wayfinding signage, which identifies key civic areas or public destinations, shall be consistent in theme and placement as determined by the City.
4. Architectural features and gateways announcing arrival to the entire community or individual neighborhoods shall have identification signs of no more than 36 square feet, the theme and placement of which is determined by the City.
5. Freestanding pole signs are prohibited. All freestanding signage must be monument-style or integrated into streetscape furniture and architectural elements.

### Sec. 5.3.B. Commercial Signs

1. In the T5 and T4 Zones, free standing signs, ground signs, and monument signs are not permitted. All signs in these zones shall be attached to the façade. Signs shall be flat against the façade, or mounted projecting or hanging from the façade.
2. Signs shall be externally lit from the front with a full-spectrum source. Back lighting is permitted as an exception only for individual letters or numbers (panelized back lighting is prohibited). Signage within the shopfront may be neon lit.
3. Maximum gross area of signs on a given façade shall not exceed ten percent of the façade area. Signage painted on a building façade or mounted on the roof may exceed this limit, with approval by the City.
4. Signs attached to the façade shall maintain a minimum clear height above sidewalks of eight feet.
5. Projecting signs shall not extend within two feet of the curb line, and shall not be placed closer than

16 inches apart.

6. Maximum area of any single sign mounted perpendicular to a given façade shall not exceed nine square feet in the T5 Zone and shall not exceed six square feet in T4, and T3 Transect Zones.
7. A single external Sign Band shall be applied to the façade of each building, provided that such sign not exceed three feet in height by any length. Letter height shall not exceed 24 inches.

#### **Sec. 5.3.C. *Banner Signs***

1. The use of banner signs shall be limited to the promotion of public events and activities, or to identify a district.
2. Banner signs shall be mounted on light poles or other street furniture designed specifically for such a purpose.
3. Banner Signs shall not be illuminated.
4. Temporary banner signs not exceeding three (3) feet in height and thirty (30) feet in length shall be hung over the public right-of-way pursuant to Chapter 4, Sec 4.4 Street Lighting.

#### **Sec. 5.3.D. *Temporary Sidewalk Signs***

1. Temporary sidewalk signs such as A-frame sandwich boards are permitted on public sidewalks immediately adjacent to a business for the purpose of advertising food or products sold within with the approval of the City.
2. The placement of signs on the sidewalk must maintain a clear sidewalk path of a minimum dimension of five feet.
3. The dimensions of the sign shall be no greater than two and a half feet wide and five feet high.
4. Temporary sidewalk signs shall not be illuminated.
5. Temporary sidewalk signs shall be approved by the City.

## **Sec. 5.4 Lighting Standards**

Adequate and quality lighting of the sidewalk and street area is essential to creating a safe and inviting streetscape.

#### **Sec. 5.4.A. *General Lighting Standards***

1. Lighting fixtures shall be appropriately chosen for the Horizon City TOD. There shall be consistency in creating a unifying scheme of illumination that is appropriate to the scale of the street and the level of evening activity.
2. Lamp styles should not be mixed along any one particular block of a street.
3. Light fixtures shall be downcast or low cut-off fixtures to prevent glare and light pollution.

4. In order to conserve energy and reduce long-term costs, energy-efficient lamps shall be used for all Public Realm lighting.

#### **Sec. 5.4.B. *Light Levels***

1. Lighting standards protect against glare, preserve the night sky, and reduce unnecessary energy use from over lighting. Rural zones tend to be darker, while higher levels of outdoor lighting may be more suitable in mixed use urban zones.
2. It is the intent of this TOD to follow Dark Sky provisions as established by the International Dark-Sky Association (IDA). All outdoor lighting within the Public Realm should be IDA-Approved fixtures.
3. The standards in Table 5-4 maintain the desired general ambient light levels across the Transect. Light levels in the Civic Transect Zone shall be consistent with the intent of this TOD and not contribute to excessive light pollution, as determined by the OTA.

#### **Sec. 5.4.C. *Street Lighting***

See Division 4: Thoroughfare Standards

#### **Sec. 5.4.D. *Parking Lot Lighting***

1. All fixtures shall be full cutoff, downward facing.
2. Light fixtures located within the interior area of a parking lot shall not exceed 30 feet in height. Light fixtures located along the perimeter edge of a parking area within 50 feet of a property line shall not exceed 15 feet.

#### **Sec. 5.4.E. *Pedestrian Walkway Lighting***

1. Light fixtures located along pedestrian walkways adjacent to parking lots shall not exceed 15 feet in height.
2. Light fixtures located along internal pedestrian walkways or paths not adjacent to a parking area shall not exceed 10 feet in height.

#### **Sec. 5.4.F. *Building and Security Lighting***

1. All exterior building or security lighting must be full cutoff, shielded, and/or angled downward to focus the light only on the intended doorway or walkway as necessary.
2. Security lighting is encouraged to be provided with regular pedestrian light fixtures where visible from the street or Public Realm to match others used on site.
3. Building mounted architectural “accent lights” are encouraged to emphasize architectural character and signage.
4. Business owners are encouraged to assist with



### Examples of Permitted Commercial Signage



Wayfinding Sign



Blade/Projecting Sign



Hanging Sign



Awning Sign



Wall Sign



Painted Wall Sign

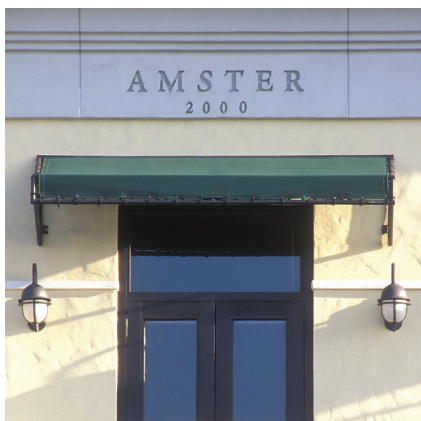

Cornice Sign



Banner Signs



Sidewalk Sign

\*Note: These examples are not inclusive of all permitted commercial signage types and designs, but are for illustrative purposes only to demonstrate the intent of the commercial signage standards.



lighting the sidewalk and to accent their business location by leaving display window and interior lighting on at night. Lighting shall be designed in such a way as to prevent the direct view of the light source to neighboring residential areas.

5. Edges of Civic Open Spaces, especially Plazas and Squares, should be lit along the Right-of-Ways to define and identify the space.
6. Focal points such as sculptures, fountains, and towers, especially those visible to pedestrians and vehicles, shall be illuminated to call attention to the element and to provide a form of wayfinding.

## Sec. 5.5 Environmental

### Sec. 5.5.A. General Provisions

The preservation and conservation of natural areas and native habitats in and around the Horizon City TOD is important. Conservation areas shall provide recreational activities. Native vegetation shall be retained in conservation areas except for limited clearing required for supporting infrastructure. These areas shall be maintained free of invasive exotic plant species.

**TABLE 5-4:  
LIGHT LEVELS**

	T3: EDGE	T4: URBAN	T5: MU CENTER
AMBIENT LIGHT LEVELS	VERY LOW	LOW	MEDIUM
<b>STANDARDS</b>			
MAXIMUM LIGHTING STANDARDS	MINIMAL LIGHTING, ALL FULL CUTOFF	FULL CUTOFF LIGHTING	FULL CUTOFF LIGHTING, SOME LOW WATTAGE, NON-FULL CUTOFF LIGHTING
NO LIGHTING LEVEL MEASURED AT THE BUILDING FRONTAGE LINE SHALL EXCEED:	1.0 FC	1.0 FC	2.0 FC
REQUIRED SHIELDING	FULLY SHIELDED LUMINAIRE WITH NO UPLIGHT OR BETTER	SHIELDED LUMINAIRE OR BETTER	PARTIALLY SHIELDED LUMINAIRE OR BETTER

# DIVISION 6: LANDSCAPE STANDARDS

## I. GENERAL CONDITIONS

### Sec. 6.1 Title

This chapter shall be known as the Landscape Ordinance for the Horizon City TOD.

### Sec. 6.2 Purpose

1. The purpose of this chapter is to set forth the minimum requirements for landscape and irrigation for property development within the limits of the Horizon TOD. The regulations herein are designed to enhance the quality of life, increase property values and aesthetics of the TOD, while helping to improve air purification, reduce stormwater run-off, noise reduction and heat abatement, while conserving energy, water and other natural resources. In addition, landscape design shall enhance the quality and character of the Public Realm by coordinating public and private space, providing spatial definition to the Public Realm, screening undesirable places/sounds/odors, and increasing health and safety, as well as complementing the architectural design of the mixed-use development.
2. In addition, landscape designers and property owners are encouraged to design and place landscape materials in a good, economically viable and environmentally sensitive manner so as to improve the aesthetics of development, construction and the quality of life for all citizens. This chapter encourages the use of quantifiable, generally recognized, scientific standards and methods as well as local and state regulations and manufacturer's recommendations in evaluating all designs.
3. This chapter is also designed to prevent soil erosion, reduce the hazards of flooding, enhance the absorption of carbon dioxide and supply of oxygen, reduce the negative effects of noise, glare and dust, promote the pleasant appearance and character of the development, provide shade to cool superheated urban areas and thus reduce water consumption in cooling units, as well as other energy consumption related to environmental cooling and facilitate the safe movement of traffic in vehicular use areas.
4. This chapter is also designed to promote water conservation and water efficiency by requiring the planting of water-thrifty, drought tolerant plants. To assist in ensuring adequate supplies of water exist for Horizon's future, it is important that water conservation be promoted in landscape watering policies. Water conservation should be promoted through techniques such as the proper design of landscaped areas and plant selection, education of the public and the proper design and use of irrigation of systems.

### Sec. 6.3 Application

1. Except as provided herein, all the requirements in these guidelines shall apply to development within the Horizon TOD area.

### Sec. 6.4 Interpretation

2. The provisions of this chapter shall be interpreted and applied, as the minimum requirements for landscape and irrigation in the TOD and shall control over all other landscape requirements in any other ordinance in the Horizon City Code.
3. It is not intended that this chapter shall interfere with, abrogate or annul any restrictive covenants or other agreements between individual parties. When there is a conflict between the requirements of this chapter and any restrictive covenant, agreements or other requirements imposed on the property, the more stringent requirement shall apply.
4. The provisions of this chapter shall be subordinate to the provisions of the Horizon City Code pertaining to traffic and pedestrian traffic.

### Sec. 6.5 Landscape Plans Required

1. Projects that are subject to the requirements of this chapter, shall require submission of separate plans for landscape and irrigation.
  - a. Landscape plans shall be designed by a landscape architect who holds a certificate of registration issued pursuant to Texas State Occupations Code Chapter 1052 and stamped with a licensed landscape architect's seal.
2. Landscape plan. The landscape plan shall include the following information:
  - a. Each plan shall be at a minimum scale of 1" equals 40', preferably 1" equals 20'. No architectural scaling shall be allowed.
  - b. Date, scale, north arrow, project title and project address; and landscape architect with their address and phone number
  - c. Name, address and telephone number of the property owner(s) representative
  - d. Botanical name and common name, plant tag showing plant type, legend reference, size, height, quantity and location of proposed landscape materials to be used
  - e. Landscape calculations, total square footage of the landscapable area provided broken down by area within the parcel, parkway and medians, parking provided, vehicular loading area, minimum required quantity of landscape materials, provided quantity of landscape materials

- f. Landscape master plan with phasing plan for multi-phase developments
- g. Location of existing and proposed structures, signs, street trees, buffer trees, parking lot trees, plant material, swales, berms and fire hydrants existing at the time of plan submission
- h. Show all curb cut ingress and egress
- i. Show a five-foot clearance at maturity for all landscape material adjacent to any utility box, hydrant, meter or access point

## II. PLANT REQUIREMENTS

### Sec. 6.6 General

1. Unlike landscape ordinances used for traditional zoning which call for a certain percentage of a parcel to be landscape area, requirements for form based code developments are dictated by building and parking lot setback requirements, and thus no percentage of property requirement is needed.
2. Approved plants. 75% of all plants to be used to satisfy these requirements shall be selected from the approved plant list included shown in Appendix B in these guidelines, with the exception of street and buffer trees, which must all be selected from the list. No artificial plant material shall be used to satisfy the requirements of this chapter.
3. All plant material shall be healthy and vigorous at the time of planting.
4. At least 50% of the plants installed shall be plant material of low water, drought-tolerant variety.
5. Trees in pedestrian areas shall be planted and maintained, with the mature branching structure having a minimum of 7' clearance from ground level within 3' from the trunk.
6. Trees shall be planted in beds with a minimum area of 36 square feet of surface area with no interior dimension less than 4' measured at 90 degrees to the interior edges.
7. At least 25% of trees required to be planted within the parcel shall be evergreen.
8. Landscaping shall be design to remain functional and attractive during all seasons through a thoughtful selection of plant varieties.
9. In order to promote sustainable landscape practices, plant varieties shall be selected for resistance to drought, moisture, salt, urban conditions, or insects and other pests depending on the location of landscaping and the specific stressors anticipated for different areas of the site, as well as for their intended function and context. Plants shall be selected so that landscaping can be maintained with minimal care and the need for watering, pesticides, or fertilizers can be minimized or

- eliminated. Native species are encouraged.
- 10. Plant material shall be installed to ensure that at maturity there is a 5' clearance adjacent to any utility box, fire hydrant, FDC connection, utility meter or access point.
- 11. Trees may not be planted in areas with less than 20' between structures
- 12. Tree wells shall be as deep as the root ball and at least twice as wide as the root ball, with the bottom of the tree well being convex. A minimum of 3" of mulch should be placed on the top of the root ball after being placed in the well.
- 13. The use of turf shall be minimized and shall not be planted in strips less than 5 feet wide. Lawn seed mixes shall be drought resistant. To achieve a high level of drought tolerance, the use of Hybrid Bermuda is encouraged.
- 14. Turf grass is specifically prohibited in parkways and medians.
- 15. In Transect Zones T2 and T3, native plant perennial landscapes should replace turf grasses where possible and be very diverse. They should be placed lower than walkways, not mounded up.
- 16. Ground treatment of landscaped areas throughout the parcel, parkway and medians shall include decomposed granite, or other permeable surfacing, not to include raw soil.
- 17. Design of landscape should maximize use of green infrastructure stormwater Best Management Practices (BMPs) such as pervious paving, bioretention systems, rain gardens, bioswales, and stormwater planters to slow and treat stormwater runoff while providing multiple additional community benefits. The OTA will approve landscaping in private front yards, civic spaces, etc.

### Sec. 6.7 Street Trees

1. Street trees shall consist of shade trees with a minimum of 3" caliper at time of planting.
2. Street trees shall be provided in a manner and at spacing as defined by the Street Type standards outlined in the Thoroughfare Standards.
3. Street trees shall be planted in the parkway and median in vegetated Planting Strips or Tree Wells with grates according to Street Types outlined in the Thoroughfare Standards.
4. For street trees located in the parkway, one street tree shall be provided for every thirty linear feet of all street frontage (with the exception of streets classified as Workplace Streets as mentioned in the Thoroughfare Standards) including any easements, but not including driveways. A minimum of one street tree shall be installed if the property has less than 30' of frontage. Street trees shall be placed in the parkway

of the street, unless the planning official requires different locations of trees based on a uniquely shaped lot.

5. For street trees located in medians, one street tree shall be provided for every 30 linear feet of median length, not including portions of median that are narrower than 5' measured from back of curb to back of curb. A minimum of one street trees shall be planted in medians that are less than 30' in length.
6. Street trees shall be selected from the approved tree and plant list contained in these guidelines.
7. The spacing for all street trees shall be at 30' or less, with the exception of Workplace Streets, which shall have street trees spaced 40' on center.
8. Adequate vertical clearance below the branches must be maintained for pedestrians, cars and bicyclists. The minimum height to the lowest branch overhanging a sidewalk shall be 7' and the lowest height overhanging a street shall be 14'.
9. Street trees shall not be required in the following situations:
  - a. Where awnings or canopies come closer than 10' from the back of the curb.
  - b. Where Galleries come closer than 20' from the back of the curb.
1. Street trees shall be aligned with light poles, where possible.
2. On sites where evenly-spaced street trees is not possible due to a uniquely shaped lot, random clustering of street trees may be acceptable, provided that the number of trees planted equals or the number that would be required if the trees were evenly-spaced. Such arrangement must be approved by the planning official.

## Sec. 6.8 Buffer Trees

Buffer trees to be located within the first 10' of the property shall be required for all new construction projects except the following:

1. Along frontage with dedicated City streets where the building or any second level balcony is set back from the property line 20' or less, and where;
2. Any awnings are set back from the property line 10' or less from the property line
3. Buffer trees shall not be required where Galleries are present.

The number of buffer trees is to be calculated as follows:

- a. One buffer tree shall be provided per every thirty linear feet of all street frontage, including

any easements, but not including driveways. A minimum of one buffer tree shall be installed if the property has less than 30' of frontage.

## Sec. 6.9 Parking Lot Trees & Landscape Area

The landscaping requirements in this section are intended to provide a set of standards toward reducing the visual impacts of large areas of pavement, improving the overall environment of parking areas by providing areas for shade and heat reduction, and enhancing the overall aesthetic appeal of parking areas.

1. Any construction of new off-street parking within the parcel is required to install one tree per ten parking spaces, or portion thereof, whether they are required parking spaces or not.
2. Any expansion of an existing parking lot is required to install one tree per ten new spaces, whether they are required parking spaces or not.
3. If the number of parking spaces provided within the parcel exceeds the maximum number of allowable spaces as indicated in the Site Development Standards, one parking lot tree for every five spaces over the maximum, or portin thereof, shall be provided. This applies to both new parking lots and parking lot expansions.
4. Parking lot trees must be placed within the property and not the parkway and placed in such as way so that all parking areas can reasonably be expected to receive 30% tree canopy coverage at tree maturity. The expected canopy radius of each selected tree shall be noted in the required site plan materials.
5. Parking lot trees may be placed within the parking area or vehicular use area with due consideration for vehicle movement and maneuvering or directly adjacent to the vehicular use area.
6. No parking space shall be more than 100' from a tree.
7. Parking lot trees shall be located with respect to the location of parking lot light fixtures in such a manner as to not impede the distribution of light throughout the parking lot, unless the lighting is placed in the canopy of the trees.
8. Parking lot trees must be placed in planting areas 36 square feet minimum with no dimension less than 4'.
9. Developments with proposed parking areas of 6 spaces or more shall provide a minimum of 10% of landscape area within the area designated for parking inclusive of any landscape borders surrounding the parking lot.
10. The ends of parking aisles in surface lots that are more than 15 spaces in length shall incorporate landscape islands at either end of the row. Each island shall

include at least one tree. Where the length of a parking aisle exceeds 25 spaces, additional landscape islands shall be installed at regular intervals. This interval shall not be more than every 13 spaces. The width of the landscape islands perpendicular to adjacent spaces shall be no less than 6'.

11. Surface parking lot entrances shall be landscaped with a combination of trees, shrubs, walls, and other landscape features. No trees, shrubs, fences, walls, or other landscape feature shall be planted in a manner to obstruct sight lines of motorists.

## Sec. 6.10 Project Trees

1. For all landscape area provided within the parcel, which is calculated as lot area minus Lot Coverage as defined in the General Provisions, project trees shall be installed as follows:
  - a. For every 1,000 square feet, or portion thereof, of landscape area provided within the parcel, one project tree having a minimum caliper size of 2" and a minimum height of 10' shall be installed
  - b. Palms may be installed on the property but will only count as three 5-gallon plants and may only be substituted for up to 50% of the required five gallon plants. See following section for shrub requirements.
  - c. Required project trees must be located within the property and not within the parkway.

## Sec. 6.11 Project Trees & Project Shrubs

1. For all landscape area provided within the parcel, which is calculated as lot area minus Lot Coverage as defined in the General Provisions, as well as in the Planting Strips in the parkways and medians, as outlined in the Thoroughfare Standards, shrubs shall be installed as follows:
  - a. For every 1,000 square feet, or portion thereof, of landscape area provided, a minimum of 45 plants of 5-gallon size, which are a minimum of 12" in height shall be provided.
  - b. Allowable substitutions are as follows;
    - (1) Ten 1-gallon shrubs may be substituted for one 5-gallon shrub for up to 50% of the required 5-gallon shrubs.
    - (2) Five 5-gallon shrubs may be substituted for one project tree for up to 50% of the required project trees.

(3) One project tree may be substituted for five 5-gallon plants.

(4) Two 1" caliper trees 8' tall may be substituted for one 2' caliper tree 10' tall for up to 50% of the required project trees.

(5) Street, buffer and parking lot trees may not be substituted

- c. Required shrubs must be located proportionally within the parcel, parkway and median based on the size of the parcel, parkway and median.
2. Plant coverage option. The following plant coverage option may be utilized in lieu of the project tree and project shrub requirements previously mentioned
  - a. Shrubs shall be provided on all landscape area provided and will cover at least 75% of the area.
  - b. Plant material used in the coverage calculation shall be shrubs or ground cover from the required approved tree and plant list contained in these guidelines. The required coverage shall be 50% achieved within two years of the date of planting and 70% at maturity. In no instance shall the number of plants provided fall below 40% of the total required under Section 2.3 A.1.
  - c. In addition to the required plant material, two project trees having a caliper size of 2" and a minimum height of 10' shall be required for every 1,000 square feet, or portion thereof. For project trees, two 1" caliper trees at a height of 8' may be substituted for a 2" caliper project tree. Project trees shall not be used in the calculation of the coverage area.
  - d. A required weather-based smart controller shall be required in order to utilize the plant coverage option.
3. Shrubs shall be a minimum size of a 5-gallon container and a minimum plant height of 12" (except for dwarf and low-growing species).
4. At least 30% of all required shrubs shall be evergreen.

## Sec. 6.12 Landscape Screen

1. Where the northern edge of the TOD abuts the property line of adjacent residential properties, a 15' wide landscape buffer area shall be provided within each developed parcel to include evergreen trees planted 15' on center for the entire length. The trees shall grow to 40' minimum at maturity. This requirement shall override other setback requirements.

## Sec. 6.13 Ground Treatment

1. Organic / inorganic ground covering / permeable paving.



- a. Inorganic coverings such as gravel, river rock, shells and similar materials may be used as a landscape groundcover within parcels.
- b. Organic ground covering such as organic mulch, pecan shells, wood chips or bark may be used as a landscape ground covering within parcels.
- c. Non-porous materials shall not be installed under organic or inorganic ground covering.
- d. Within the public right of way, landscape rock, Desert Tan color, shall be used.
- e. Any weed barrier materials used must allow the percolation of standing water within 72 hours.
- f. When using rock 2" or larger, smaller rock shall be mixed in to fill in gaps between larger rock and hide the weed-barrier fabric from view, when weed-barrier is used.
- g. Boulders, Desert Tan color, shall be provided in the Planting Strips in the public ROW. Boulders shall be a mix of 1', 2' and 3', with the mix of sizes providing a more natural appearance.

## Sec. 6.14 Irrigation

For all required plant material, an underground automatic irrigation system shall be provided in compliance with the requirements of this chapter and in compliance with the requirements of 30 Texas Administrative Code, Chapter 344, §§ 344.72—344.77, and as may be amended. When irrigation systems are provided, sustainable systems, such as low volume heads, drip irrigation, and other water efficiency methods are encouraged. Connect to "purple" pipe system separated from DCW if purple pipe is present

## Sec. 6.15 Stormwater Management

### Sec. 6.1.A. General Standards

1. The objectives of the stormwater management standards are to reduce water quality impacts at receiving waters, enhance community character in support of compact development, and promote public health, safety, and welfare. The stormwater management standards include the following goals:
  - (a) Manage rainfall as close to where it falls as possible, approximating the natural pre-development hydrology (water quality and water quantity) by using natural, decentralized stormwater management practices that do not impede or negatively alter the historic flow of stormwater runoff.
  - (b) Establish watershed sensitive planning and design criteria at the neighborhood scale of development to support shared flood

control solutions.

- (c) Encourage incorporation of Light Imprint Best Management Practices (BMPs) at the block, street, and site scales of development, appropriate to land use context and site conditions.
2. A Stormwater Management System shall be developed to manage stormwater in each Neighborhood as a whole.
  3. Stormwater management shall be implemented within a Final Site Plan.
  4. Stormwater standards for individual Lots within the neighborhood can assist in meeting the standards of the neighborhood as a whole.
  5. All stormwater shall be managed in accordance with any applicable land development code.

### Sec. 6.1.B. Light Imprint Storm Drainage Methods

1. Appendix A provides recommended stormwater management methods as outlined in the *Light Imprint Handbook*. These methods shall be utilized as the elements of the neighborhood stormwater strategy and the Final Site Plan detailed stormwater management plan. At least one of these methods shall be applied at the neighborhood, corridor, and Lot levels to implement the neighborhood stormwater strategy. Refer to the *Light Imprint Handbook* for comprehensive descriptions of each method and its application.
2. The Light Imprint stormwater management methods appropriate for use within the Civic Transect Zone shall be determined by the OTA on a site-by-site basis based on the use and character of each site.

### Sec. 6.1.C. Design Criteria

1. Properly designed Pervious Paving shall be permitted and is encouraged to reduce stormwater runoff volume. Pervious Paving approaches may be technically infeasible where underlying soils are contaminated or other site constraints exist.
2. Green roofs shall be permitted for all building types.
3. Roof drains shall not outfall onto impervious pedestrian use areas and should instead be directed to underground storm drainage systems or a vegetated stormwater management system.
4. Irrigation systems are encouraged to first make use of all available surface stormwater runoff or other retained or detained stormwater as a water supply.
5. Bioretention systems, rain gardens, bioswales, tree filters, and other vegetated stormwater management systems are encouraged for treatment



of stormwater runoff from streets, parking lots, plazas, and other impervious surfaces. These vegetated stormwater management systems can include impermeable liners with underdrains to provide water quality treatment where infiltration is not technically feasible due to site contamination concerns.

6. Trees should be planted below the grade of the sidewalk and the street. Structural cells should be used for trees planted in tree wells, or in plazas or other paved areas, to ensure sufficient root space for healthy tree growth and to increase the stormwater management potential of the trees.
7. Special Detention Areas such as parking lots, rooftops (“blue roofs”), parks, plazas, and fields are areas primarily designated for other uses but that may be used for temporary infiltration and/or peak rate mitigation during storm events if the requirements herein are satisfied. Special Detention Areas shall be designed sensitive to land use context and public use requirements and the following conditions:
  - (a) Temporary storage areas must be located so that ponding will not significantly disrupt typical traffic (pedestrian/bicycle/vehicle) flow, and areas should be adequately sloped towards outlets to ensure complete drainage after storm events.
  - (b) Special Detention Areas shall be clearly identified as such and their use shall be restricted during and after storms.
  - (c) Emergency overflows shall be incorporated and designed to prevent excessive depths from occurring during extreme storm events or if the primary flow control structure/structures are clogged. In most cases, ponding depth shall not exceed 12 inches.
  - (d) Rooftop storage must consider structural support, HVAC requirements, waterproofing, emergency overflows, and all other building design considerations.
  - (e) Landscape or turf Special Detention Areas used for high-intensity public uses (community parks, athletic fields, greens, etc.) shall be located in areas of well-draining soils to guarantee public use is not compromised by excessively wet ground between rain events.

## Sec. 6.16 Environmental

### Sec. 6.1.A. General Provisions

The preservation and conservation of natural areas and native habitats in and around the Horizon City TOD is important. Conservation areas may provide recreational activities. Native vegetation shall be retained in conservation areas except for limited clearing required for trails, boardwalks, agricultural fencing, supporting infrastructure and existing agricultural uses. These areas shall be maintained free of invasive exotic plant species.

## Sec. 6.17 Installation

Landscape and irrigation systems shall be installed in accordance with the approved plan.

8. Minor modifications may be made to the landscape design (plant materials and irrigation system), by the landscape architect or designer, so long as the changes comply with the minimum standards applicable to this chapter.
9. Minor modifications shall be allowed within the landscape area as long as those changes do not affect the plant size or required quantity and that the irrigation changes do not affect the hydraulic integrity of the system.
10. Landscape installation shall be in substantial conformance with the approved plans. Significant alterations in the design or installation without appropriate plan amendment approval is subject to withholding of final inspection approval.
11. Installation shall be completed prior to the building final inspection.
12. An individual with a state irrigator, irrigation technician, master plumber, or journeyman plumber license shall be on the project site during all irrigation installation work to review and inspect all progress and aspects of the installation.

## Sec. 6.18 Maintenance

1. Landscaping and irrigation shall be regularly and properly maintained to ensure healthy and vigorous plant material. The property owner is responsible for regular weeding, mowing of grass, irrigating, fertilizing, pest prevention, pruning and other maintenance of all plantings as needed. Trees may not be trimmed beyond national nursery standards for any reason.
2. Landscaping which dies shall be replaced by the owner with another living plant that is comparable to the existing plant or plant materials specified in the approved landscape plan as expeditiously as possible, but in any event no later than 60 days after notification

from the City representative. The City representative may extend this time period up to an additional 30 days due to weather or due to events outside of the control of the property owner.

3. Maintenance and trimming of street trees and replacement of dead trees are the responsibility of the owner of the lot adjacent to or on which the trees are located. Street trees shall be maintained alive and healthy by the property owner of the lot adjacent the parkway or on which the tree is located.

## IV. ADMINISTRATION

### Sec. 6.19 Enforcement

1. Revocation of permit. Permits may be revoked in accordance with the provisions in the Horizon City Code.
2. Citations. Employees authorized by the City, to include but not be limited to the city development director and building official and their designees, and the code enforcement division, are authorized to enforce the provisions of this chapter and shall have the power to issue misdemeanor citations to any persons violating the provisions of this chapter.

### Sec. 6.20 Appeals

When the City does not approve a landscape or irrigation plan, or the installation of these improvements, the owner or duly authorized representative may appeal in writing that decision. Where the unique characteristics of a particular lot are such that the landscape requirements cannot be met, the planning director or designee may waive up fifteen percent of the parking requirement below the minimum so that the minimum landscape requirement can be met or alternatively the missing landscape percentage can be waived. In cases where the property owner disagrees with the determination of the planning director or other designee of the city manager, the decision may be appealed in writing.

### Sec. 6.21 Violations & Penalty

1. Civil and criminal penalties. The City shall have the power to administer and enforce the provisions of this chapter as may be required by governing law. Any person, firm, corporation or agent who shall violate a provision of this chapter, or fails to comply therewith, or with any of the requirements thereof, or who shall have erected, constructed, altered, repaired, installed, demolished or moved any landscaping or irrigation system, in violation of a detailed statement or drawing

submitted and permitted under this chapter, is subject to suit for injunctive relief as well as prosecution for criminal violations. Any violation of a provision in this chapter is declared to be a nuisance.

2. Criminal prosecution. Any person violating any provision of this chapter shall, upon conviction, be fined a sum not exceeding two thousand dollars. Each day that a provision of this chapter is violated shall constitute a separate offense.
3. Civil remedies. Nothing in this chapter shall be construed as a waiver of the City's right to bring a civil action to enforce the provisions of this chapter and to seek remedies as allowed by law, including, but not limited to the following:
  - a. Injunctive relief to prevent specific conduct that violates the ordinance or to require specific conduct that is necessary for compliance with the ordinance; and
  - b. A civil penalty up to five hundred dollars a day when it is shown that the defendant was actually notified of the provisions of the ordinance and after receiving notice committed acts in violation of the ordinance or failed to take action necessary for compliance with the ordinance; and
  - c. Other available relief.

### Sec. 6.22 Severability

If any section, subsection, sentence, clause or phrase of this chapter is for any reason held to be unconstitutional, such decision shall not affect the validity of the remaining portions of this chapter.

### Sec. 6.23 Rules

The following rules of construction shall apply:

- a. The singular number includes the plural and the plural the singular, unless the context clearly indicates the contrary.
- b. Words used in the present tense include the past and future tenses, and the future the present.
- c. The word 'shall' is always mandatory. The word 'may' is permissive.
- d. Words and terms not defined herein shall be interpreted in accord with Webster's Third New International Dictionary, Copyright 1986.

### Sec. 6.24 Definitions

The following terms as used in this chapter shall be defined as follows:

1. 'Approved irrigator' means a Texas licensed irrigator.
2. 'Approved plant list' means the list of plants and shrubs included in these guidelines.
3. 'Automatic controller' means a mechanical, electrical or hybrid solid state timing device,

- capable of operating valve stations by set days of the week and the length of time of water application.
4. 'Backflow prevention device' means a safety device used to prevent pollution or contamination of the potable water supply due to the reverse flow of water from the irrigation system.
  5. 'Berm, earthen' means an earthen mound designed to provide visual interest or screen undesirable views and decrease noise.
  6. 'Caliper' means the measurement of the thickness of a tree; the minimum diameter of a tree as measured six inches above the grade for trees under four inches in diameter and twelve inches above grade for trees four inches in diameter and larger. For multiple trunk trees, the diameter shall be based on the caliper of the largest trunk plus half the caliper of the next three largest trunks.
  7. 'Deciduous' means a plant that sheds its foliage annually.
  8. 'Development' means all developments for parcels within the Horizon TOD area.
  9. 'Director' means the city manager or designee.
  10. 'Evergreen' means a plant with foliage that persists and remains green year round.
  11. 'Finish grade' means the ground elevation in its final and finished state before any landscape is installed.
  12. 'Frontage' means the property line where a parcel of land, lot, or site abuts a public right-of-way.
  13. 'Frontage landscape buffer area' means the ten foot wide area from the public right-of-way line into the property, along the frontage street.
  14. 'Grass'. See 'turf or turf grass.'
  15. 'Gross building area' means the total enclosed area of a building exterior dimensions, excluding covered walkways or exterior fire escapes.
  16. "Ground covering" means organic or inorganic material such as mulches and/or gravel used as ground covering.
  17. 'Ground cover organic' means low growing plant material, other than turf grasses, installed in such a manner as to provide continuous cover of the ground surface.
  18. 'Hardscape' means the use of solid non-organic materials such as rock or stone, concrete, asphalt, brick, or other similar type material.
  19. 'Impervious soil' means soil which is extremely dense (cementitious sedimentary soil) through which water will not readily penetrate adding to potential stormwater runoff and consists of a rainfall coefficient of at least .95.
  20. 'Impervious surfaces' means any surface such as roofing, solid surface plastic materials, solid surface oil-impregnated materials, concrete, asphalt, etc. through which water will not readily penetrate adding to potential stormwater runoff and consists of a rainfall coefficient of 1.0.
  21. 'Landscapable area' means that area of the lot that is required by this chapter to be landscaped, to include the frontage landscape buffer used to meet the landscape requirements specified in this chapter. It does not include the parkway or the parking lot trees.
  22. 'Landscaping' means the improvement of a section of ground by contouring the land and planting any combination of living plants, such as trees, shrubs, vines, groundcover or grass, natural features such as rock, stone, bark chips or shavings.
  23. 'Median' means the area within the public right-of-way, which separates two opposite directions of traffic.
  24. 'Mulch' means organic and/or inorganic material, which is placed, to prevent erosion, lower soil temperature and maintain soil moisture levels.
  25. 'Official' means the building official or his designee.
  26. 'Palm' means a long-lived plant of the family Palmae having a minimum eight feet unbranched clear trunk crowned by large pinnate or palmate leaves.
  27. 'Parking lot' for the purposes of this chapter, 'parking lot' means any paved or unpaved area, not including a street or alley right-of-way, containing one or more parking spaces for motor vehicles, designed in accordance with the requirements of the Horizon City Code, and intended as an accommodation for patrons, customers, and employees, either with or without a charge for such accommodation.
  28. 'Parking spaces' means those spaces for the parking of any vehicle excluding eighteen-wheel tractors and their trailers.
  29. 'Parkway' means that area of street right-of-way between the property line and the curb or, in the absence of a curb, between the property line and the nearest edge of the street paving.
  30. 'Permeable surfacing' means materials with a permeable base.
  31. 'Plant, native or well-adapted' means a commercially grown or legally harvested plant material hardy to the natural conditions of the region, which once established is capable of sustaining growth without supplemental watering.
  32. 'Plant material' means the required trees and other plants that are required to be installed.
  33. 'Pond' means a depression in the soil intended to retain and/or detain both stormwater and all excess irrigation water.

34. 'Project' means a specific development which is subject to the requirements as stated herein.
35. 'Shrub' means a woody plant, deciduous or evergreen, generally multi-stemmed with small branches near the ground, and smaller growing than a tree.
36. 'Street oriented building' means the placement of a building on a lot such that its principal orientation is toward the street and the principal entrance is from the sidewalk. Street oriented buildings prohibit parking in any space between the sidewalk and the building.
37. 'Stormwater' means a buildup of naturally occurring precipitation (water), which falls on any parcel of land (site or watershed) of any given size.
38. 'Structure' for the purposes of this chapter, 'structure' means that which is built or constructed, an edifice or building of any kind, with four walls and a roof that encloses the interior space from the outside elements, or other artificially built or constructed work.
39. 'Swale' means a landscape design using a depressed earthen channel of any depth or width designed to direct or move water to or from ponds, other swales, channels, arroyos or other drainage conveyance.
40. 'Texas Licensed Irrigator' means a person who sells, designs, offers consultations regarding, installs, maintains, alters, repairs, services or supervises the installation of an irrigation system, including the connection of such system to a private or public, raw or potable water supply system or any water supply, and who is required to be licensed under Title 30, Texas Administrative Code, Chapter 30.
41. 'Tree, buffer' means a deciduous or evergreen tree having a minimum of two inches caliper and ten feet in height which is planted with the frontage landscape buffer area of the property along the street frontage.
42. 'Tree, parking lot' means a deciduous or evergreen tree having a minimum of two inches caliper and ten feet in height, which is capable of obtaining a minimum canopy, spread of twenty feet at maturity. Branching structure shall be maintained at a minimum height of seven feet above the sidewalk area ground, three feet from the trunk; which is installed and located in a parking lot.
43. 'Tree, project' means a deciduous or evergreen tree having a minimum of two inches caliper and ten feet in height, which is capable of obtaining a minimum canopy spread of twenty feet at maturity that is required based on calculations determined by the provisions of this chapter. Branching structure shall be maintained at a minimum height of seven feet above the sidewalk area ground, three feet from the trunk.
44. 'Tree, street' means a deciduous or evergreen tree growing within the parkway or median of a street having a minimum of three inches caliper and twelve feet in height.
45. 'Tree grate' means a barrier with parallel or crossed bars blocking a passage but allows for tree trunk diameter growth.
46. 'Tree well' means the basin where the root ball of the tree is planted.
47. 'Turf or turf grass' means a surface layer of soil bound by grass and its roots into a thick mat that requires regular maintenance, mowing and watering.
48. 'Unit of plant material' means one project deciduous or evergreen tree having a minimum caliper size of two inches and a minimum height of ten feet and a minimum of forty-five plants of five-gallon size, which are a minimum of twelve inches in height.
49. 'Unmanned facility' means a structure which does not require a certificate of occupancy and is not occupied by any persons.
50. 'Vehicular loading area' means a paved area designed to accommodate the maneuvering, loading and unloading and parking of commercial vehicles having a length of less than twenty-seven feet.
51. 'Vehicular use area' means any area, excluding public rights-of-way, used for the purpose of driving, maneuvering, parking, storing or display of motor vehicles and other parking lot uses.
52. 'Visibility triangle' means the area formed by the intersecting property lines and a diagonal line joining the property lines at the points twenty feet from their intersection on the corner lot at the intersecting corner.
53. 'Water harvesting' means the process of intercepting irrigation or stormwater from a surface such as a roof, parking area or land surface and putting it to beneficial use thereby reducing runoff and making maximum use of irrigation and rain water.
54. 'Weed barrier' means a porous overlay material used beneath mulch materials to reduce the germination and growth of unwanted plant material while allowing the percolation of water.

## Appendix A

LIGHT IMPRINT STORM DRAINAGE	T3: SUB-URBAN	T4: URBAN	T5: MIXED USE CENTER	C: CIVIC
<b>PAVING</b>				
COMPACTED EARTH	■			
WOOD PLANKS	■			
PLASTIC MESH/GEOMAT	■	■		
CRUSHED STONE/SHELL	■	■		
CAST/PRESSED CONCRETE PAVER BLOCK	■	■	■	■
GRASSED CELLULAR PLASTIC	■	■	■	■
GRASSED CELLULAR CONCRETE	■	■	■	■
PERVIOUS ASPHALT	■	■	■	■
ASPHALT	■	■	■	■
CONCRETE	■	■	■	■
PERVIOUS CONCRETE	■	■	■	■
STAMPED ASPHALT	■	■	■	■
STAMPED CONCRETE	■	■	■	■
PEA GRAVEL		■	■	■
STONE/MASONRY PAVING BLOCKS		■	■	■
WOOD PAVING BLOCKS ON CONCRETE			■	■
ASPHALT PAVING BLOCKS			■	■
<b>CHANNELING</b>				
NATURAL CREEK				
TERRACING	■			
VEGETATIVE SWALE	■			
DRAINAGE DITCH	■			
STONE/RIP RAP CHANNELS	■	■		
VEGETATIVE/STONE SWALE	■	■	■	■
GRASSED CELLULAR PLASTIC	■	■	■	■
GRASSED CELLULAR CONCRETE	■	■	■	■
SOAKAWAY TRENCH	■	■	■	■
SLOPE AVENUE	■	■	■	■
FRENCH DRAIN	■	■	■	■
SHALLOW CHANNEL FOOTPATH/RAINWATER CONVEYOR	■	■	■	■
CONCRETE PIPE	■	■	■	■
GUTTER	■	■	■	■
PLANTING STRIP TRENCH	■	■	■	■
MASONRY TROUGH		■	■	■
CANAL		■	■	■

# DRAFT

LIGHT IMPRINT STORM DRAINAGE	T3: SUB-URBAN	T4: URBAN	T5: MIXED USE CENTER	C: CIVIC
SCULPTED WATERCOURSE, I.E. CASCADES			■	■
CONCRETE TROUGH			■	■
ARCHIMEDEAN SCREW			■	■
STORAGE				
IRRIGATION POND	■			
RETENTION BASIN WITH SLOPING BANK	■			
RETENTION BASIN WITH FENCE	■	■		
RETENTION HOLLOW	■	■		
DETENTION POND	■	■		
VEGETATIVE PURIFICATION BED	■	■	■	■
FLOWING PARK	■	■	■	■
RETENTION POND	■	■	■	■
LANDSCAPED TREE WELL		■	■	■
POOL/FOUNTAIN		■	■	■
UNDERGROUND VAULT/PIPE/CISTERN		■	■	■
GRATED TREE WELL			■	■
UNDERGROUND WAUL/PIPE/CICTERN-PLASTIC			■	■
PAVED BASIN			■	■
FILTRATION				
WETLAND/SWAMP				
FILTRATION PONDS				
SHALLOW MARSH	■			
SURFACE LANDSCAPE	■			
NATURAL VEGETATION	■	■	■	■
CONSTRUCTED WETLAND	■			
BIO-RETENTION SWALE	■	■		
PURIFICATION BIOTYPE	■	■	■	■
GREEN FINGER	■	■	■	■
ROOF GARDEN	■	■		
RAIN GARDEN	■	■		
DETENTION POND	■	■		
GRASSED CELLULAR PLASTIC	■	■		
GRASSED CELLULAR CONCRETE	■	■		
WATERSCAPES		■	■	■



## Appendix B

TOD APPROVED PLANT LIST				
SCIENTIFIC NAME	COMMON NAME	STREET / BUFFER TREE	PROJECT TREE	PARKING LOT TREE
<b>LARGE TREES (50' OR MORE)</b>				
CALOCEDRUS DECURRENS	INCENSE CEDAR SELECTIONS	NO	YES	NO
CARYA ILLINOENSIS	PECAN	NO	YES	NO
CEDRUS DEODARA	DEODAR CEDAR	NO	YES	NO
CUPRESSUS SEMPERVIRENS	ITALIAN CYPRESS	NO	NO	NO
FRAXINUS TEXENSIS	TEXAS ASH	NO	YES	YES
GYMNOCLADUS DIOICUS	KENTUCKY COFFEE TREE	NO	YES	NO
JUGLANS ARIZONICA	ARIZONA WALNUT	NO	YES	YES
MACLURA POMIFERA	OSAGE ORANGE	YES	YES	NO
PINUS ELДАРICA	AFGHAN, MONDEL PINE	YES	YES	YES
PINUS ENGLEMANIA	APACHE PINE	YES	YES	NO
PINUS HALEPENSIS	ALEPPO PINE	YES	YES	YES
PINUS PINEA	ITALIAN STONE PINE	YES	YES	YES
PINUS ROXBURGHII	CHIR PINE	YES	YES	YES
PLATANUS WRIGHTII	ARIZONA SYCAMORE	NO	YES	NO
POPULUS DELTOIDES	COTTONWOOD	NO	YES	NO
POPULUS FREMONTII	ARIZONA COTTONWOOD	NO	YES	NO
QUERCUS AGRIFOLIA	COASTAL OAK	YES	YES	YES
QUERCUS LOBATA	VALLEY OAK	YES	YES	YES
QUERCUS MACROCARPA	BUR OAK	NO	YES	YES
QUERCUS MUHLENBERGII	CHINQUAPIN OAK	YES	YES	YES
QUERCUS POLYMORPHA	MEXICAN WHITE OAK	YES	YES	YES
TAXODIUM MUCRONATUM	MONTEZUMA CYPRESS	NO	YES	YES
WASHINGTONIA FILIFERA	CALIFORNIA FAN PALM	NO	CLUSTERED ONLY	CLUSTERED ONLY
WASHINGTONIA ROBUSTA	MEXICAN FAN PALM	NO	CLUSTERED ONLY	CLUSTERED ONLY
<b>MEDIUM TREES (BETWEEN 30' AND 49')</b>				
ACACIA STENOPHYLLA	SHOESTRING ACACIA	NO	YES	YES

ACER GRANDIDENTATUM	BIGTOOTH MAPLE	NO	YES	NO
BRAHEA ARMATA	MEXICAN BLUE PALM	NO	CLUSTERED ONLY	NO
CEDRUS ATLANTICA	BLUE ATLAS CEDAR	NO	YES	NO
CELTIS LAEVIGATA VAR. LAEVIGATA	HACKBERRY OR SUGARBERRY	YES	YES	YES
CUPRESSUS ARIZONICA (C. GLABRA)	ARIZONA CYPRESS SELECTIONS	YES	YES	NO
CUPRESSOCYPARIS LEYLANDII	LEYLAND CYPRESS	YES	YES	NO
FRAXINUS ANGUSTIFOLIA (F. OXYCARPA)	RAYWOOD ASH	YES	YES	YES
FRAXINUS VELUTINA	ARIZONA OR VELVET ASH SELECTIONS	NO	YES	YES
GLEDITSIA TRIACANTHOS INERMIS	THORNLESS HONEYLOCUST SELECTIONS	NO	YES	NO
JUGLANS MICROCARPA	NOGALITO, LITTLE LEAF WALNUT	YES	YES	YES
JUNIPERUS SCOPULORUM	ROCKY MOUNTAIN JUNIPER SELECTIONS	YES	YES	NO
JUNIPERUS VIRGINIANA	EASTERN RED CEDAR SELECTIONS	YES	YES	NO
PHOENIX DACTYLIFERA	DATE PALM	NO	CLUSTERED ONLY	CLUSTERED ONLY
PINUS CEMBROIDES	MEXICAN PINYON PINE	YES	YES	NO
PISTACIA ATLANTICA	MT. ATLAS PISTACHE	YES	YES	YES
PISTACIA CHINENSIS	CHINESE PISTACHE SELECTIONS	YES	YES	YES
PROSOPIS GLANDULOSA VAR. GLANDULOSA	HONEY MESQUITE	YES	YES	YES
PRUNUS SEROTINA	SOUTHWESTERN CHOKE CHERRY	NO	YES	NO
QUERCUS ARIZONICA	ARIZONA WHITE OAK	YES	YES	YES
QUERCUS BUCKLEYI	TEXAS RED OAK, SPANISH OAK	YES	YES	YES
QUERCUS FUSIFORMIS	ESCARPMENT LIVE OAK	YES	YES	YES
QUERCUS GRAVESII	CHISOS RED OAK	YES	YES	YES
QUERCUS GRISEA	GRAY OAK	YES	YES	YES
QUERCUS LACEYI	LACEY OAK	YES	YES	YES
QUERCUS SUBER	CORK OAK	YES	YES	YES

# DRAFT

QUERCUS VIRGINIANA	SOUTHERN LIVE OAK	YES	YES	YES
ROBINIA X AMBIGUA	PINK/PURPLE LOCUST	YES	YES	NO
SALIX GOODINGII	GOODING WILLOW	NO	YES	NO
SAPINDUS SAPONARIA VAR. DRUMMONDII	WESTERN SOAPBERRY	YES	YES	YES
SOPHORA JAPONICA	JAPANESE PAGODA TREE	NO	YES	YES
ULMUS CRASSIFOLIA	CEDAR ELM	YES	YES	YES
ULMUS PARVIFLORA	LACEBARK ELM	YES	YES	YES
<b>SMALL TREES (LESS THAN 30')</b>				
ACACIA FARNESIANA (A. SMALLII)	SWEET ACACIA	YES	YES	NO
ACACIA GREGGII (A. WRIGHTII)	CATCLAW ACACIA	NO	YES	NO
ARBUTUS XALAPENSIS	TEXAS MADRONE	NO	NO	NO
BUMELIA LANUGINOSA	CHITTAMWOOD, GUM BUMELIA	YES	YES	NO
CELTIS LAEVIGATA VAR. RETICULATA	NETLEAF OR CANYON HACKBERRY	YES	YES	YES
CERCIS CANADENSIS VAR. MEXICANA	MEXICAN REDBUD	YES	YES	NO
CERCIS CANADENSIS VAR. TEXANA	TEXAS REDBUD	YES	YES	NO
CHAMAEROPS HUMILIS	MEDITERRANEAN FAN PALM	NO	CLUSTERED ONLY	CLUSTERED ONLY
CHILOPSIS LINEARIS	DESERT WILLOW	YES	YES	YES
CORDIA BOSSERII	MEXICAN OLIVE	YES	YES	NO
COTINUS COGGYGRIA	SMOKETREE	NO	YES	NO
DIOSPYROS TEXANA	TEXAS PERSIMMON	NO	YES	NO
FRAXINUS CUSPIDATA	FRAGRANT ASH	NO	YES	NO
JUNIPERUS CHINENSIS 'BLUE POINT'	BLUE POINT JUNIPER	NO	YES	NO
JUNIPERUS DEPPEANA	ALLIGATOR JUNIPER	YES	YES	NO
JUNIPERUS MONOSPERMA	ONE-SEEDED JUNIPER	YES	YES	NO
KOELREUTERIA PANICULATA	GOLDEN RAIN TREE	NO	YES	YES
LEUCEANA RETUSA	GOLDENBALL LEADTREE	YES	YES	NO
PARKINSONIA X CERCIDIUM "DESERT MUSEUM"	PALO VERDE HYBIRDS	YES	YES	YES
PARKINSONIA FLORIDUM	BLUE PALO VERDE	YES	YES	YES
PARKINSONIA MICROPHYLLUM	FOOTHILLS PALO VERDE	YES	YES	YES
PINUS EDULIS	PINYON PINE	NO	YES	NO
PINUS THUNBERGIANA	JAPANESE BLACK PINE	NO	YES	NO

PISTACIA MEXICANA (P. TEXANA)	TEXAS PISTACHE	YES	YES	NO
PROSOPIS GLANDULOSA VAR. TORREYANA	TORREY MESQUITE	YES	YES	NO
PROSOPIS PUBESCENS	SCREWBEAN MESQUITE	YES	YES	NO
PRUNUS MEXICANA	MEXICAN PLUM	YES	YES	NO
QUERCUS GAMBELII	GAMBEL'S OAK	YES	YES	NO
QUERCUS ILEX	HOLLY OAK	YES	YES	YES
QUERCUS OBLONGIFOLIA	MEXICAN BLUE OAK	YES	YES	NO
QUERCUS PUNGENS (Q. VASEYI)	SANDPAPER OAK	YES	YES	NO

SHRUBS	
ABELIA GRANDIFLORA	GLOSSY ABELIA
ACACIA BERLANDIERI	GUAJILLO
ACACIA CONSTRICTA	WHITETHORN ACACIA
ACACIA RIGIDULA	BLACKBRUSH ACACIA
ALOYSIA GRATISSIMA (A. LYCIOIDES)	WHITE BEEBRUSH
AMORPHA FRUTICOSA	FALSE INDIGO BUSH
ANISACANTHUS QUADRIFIDUS VAR. WRIGHTII	FLAME ACANTHUS
ANISACANTHUS THURBERI	DESERT HONEYSUCKLE
ARTEMISIA FILIFOLIA	SAND SAGEBRUSH
ATRIPLEX CANESCENS	FOUR-WING SALTBUCH
BAUHINIA LUNARIOIDES (B. CONGESTA)	ANACACHO ORCHID TREE
BERBERIS HAEMATOCARPA	RED BARBERRY
BERBERIS THUNBERGII 'ATROPURPUREA'	RED-LEAF JAPANESE BARBERRY
BERBERIS TRIFOLIOLATA	ALGERITA, AGARITO
BUDDLEJA DAVIDII	BUTTERFLY BUSH
BUDDLEJA MARRUBIIFOLIA	WOOLLY BUTTERFLY BUSH
CAESALPINIA GILLIESII	DESERT BIRD-OF-PARADISE
CAESALPINIA MEXICANA	MEXICAN BIRD-OF-PARADISE
CAESALPINIA PULCHERRIMA	RED BIRD-OF-PARADISE
CALLIANDRA ERIOPHYLLA	FAIRY DUSTER
CALLIANDRA X HYBRID "RED STAR"	RED FAIRY DUSTER HYBRID
CERCOCARPUS LEDIFOLIUS	CURLLEAF MT. MAHOGANY
CERCOCARPUS MONTANUS	MOUNTAIN MAHOGANY
CHRYSACTINIA MEXICANA	DAMIANITA
CORDIA PARVIFOLIA	LITTLELEAF CORDIA
COTONEASTER LACTEUS "PARNEYI"	RED CLUSTERBERRY
DALEA BICOLOR V. BICOLOR	BLUE DALEA
DALEA FRUTESCENS	BLACK DALEA
DALEA LUTEA	YELLOW DALEA
DALEA PULCHRA	INDIGO BUSH
DALEA VERSICOLOR VAR. SESSILIS	WISLIZENII DALEA
ELAEAGNUS PUNGENS	SILVERBERRY
ERICAMERIA LARICIFOLIA	TURPENTINE BUSH
ERICAMERIA NAUSEOUS (CHRYSOTHAMNUS NAUSEOUS)	RUBBER RABBITBUSH
ERIOGONUM FASCICULATUM	FLATTOP BUCKWHEAT

ERIOGONUM WRIGHTII	WRIGHT'S BUCKWHEAT
EUONYMUS JAPONICA	EVERGREEN EUONYMUS SELECTIONS
EYSENHARDTIA ORTHOCARPA	ARIZONA KIDNEYWOOD
EYSENHARDTIA TEXANA	TEXAS KIDNEYWOOD
FALLUGIA PARADOXA	APACHE PLUME
FEIJOA SELLOWIANA	PINEAPPLE GUAVA
FENDLERIA RUPICOLA	CLIFF FENDLERBUSH
FORESTIERA PUBESCENS (F. NEOMEXICANA)	NEW MEXICO PRIVET
FRAXINUS GREGGI	LITTLELEAF ASH
ILEX VOMITORIA	YAUPON HOLLY SELECTIONS
JUNIPERUS CHINENSIS	CHINESE JUNIPER SELECTIONS
KRASCHENINNIKOVIA LANATA (CERATOIDES LANATA)	WINTERFAT
LAGERSTROEMIA INDICA	CREPE MYRTLE
LANTANA CAMARA	BUSH LANTANA
LANTANA HORRIDA	TEXAS LANTANA
LARREA TRIDENTATA	CREOSOTE BUSH
LEUCOPHYLLUM CANDIDUM	SILVER LEAF SELECTIONS
LEUCOPHYLLUM FRUTESCENS	TEXAS SAGE SELECTIONS
LEUCOPHYLLUM LAEVIGATUM	CHIHUAHUAN RAIN SAGE
LEUCOPHYLLUM LANGMANIAE	CINNAMON SAGE SELECTIONS
LEUCOPHYLLUM PRUINOSUM	FRAGRANT SAGE
LEUCOPHYLLUM REVOLTUM	CURL LEAF SAGE
LEUCOPHYLLUM ZYGOPHYLLUM	BLUE RANGER
LONICERA ALBIFLORA	WHITE HONEYSUCKLE
MIMOSA DYSOCARPA	VELVETPOD MIMOSA
NANDINA DOMESTICA	HEAVENLY BAMBOO
NERIUM OLEANDER	OLEANDER SELECTIONS
PARTHENIUM INCANUM	MARIOLA
PHILADEPHUS MICROPHYLLA	LITTLE LEAF MOCK ORANGE
PLATYCLADUS ORIENTALIS (THUJA ORIENTALIS)	ORIENTAL ARBORVITAE
POLIOMINTHA MADERENSIS	LAVENDER SPICE
POLIOMINTHA INCANA	DESERT ROSEMARY
PRUNUS TRILOBA	FLOWERING ALMOND
PTELEA TRIFOLIATA	HOP TREE
PUNICA GRANATUM	POMEGRANATE SELECTIONS
PURSHIA MEXICANA (COWANIA MEXICANA)	CLIFFROSE
PYRACANTHA SPECIES	PYRACANTHA SELECTIONS
QUERCUS TURBINELLA	SHRUB OAK
RAPHIOLEPIS INDICA	INDIAN HAWTHORNE SELECTIONS
RHUS GLABRA	SMOOTH SUMAC
RHUS MICROPHYLLA	LITTLELEAF SUMAC
RHUS OVATA	SUGAR BUSH
RHUS TRILOBATA	THREELEAF SUMAC SELECTIONS
RHUS VIRENS (R. CHORIOPHYLLA)	EVERGREEN SUMAC
ROSA BANKSIAE	LADY BANK'S ROSE
ROSMARINUS OFFICINALIS	ROSEMARY
SALVIA CLEVELANDII	CHAPARRAL SAGE
SALVIA GREGGII	AUTUMN SAGE SELECTIONS
SALVIA MICROPHYLLA	BABY SAGE SELECTIONS

SANTOLINA CHAMAECYPARISSUS (S. INCANA)	GREY LAVENDER COTTON
SANTOLINA ROSMARINIFOLIA (S. VIRENS)	GREEN LAVENDER COTTON
SENNA ARTEMISIOIDES (CASSIA ARTEMISIOIDES)	FEATHER SENNA
SENNA LINDHEIMERIANA (CASSIA LINDHEIMERIANA)	VELVET-LEAF SENNA
SENNA NEMOPHILA (CASSIA NEMOPHILA)	DESERT SENNA
SENNA WISLIZENII (CASSIA WISLIZENII)	SHRUBBY SENNA
SOPHORA SECUNDIFLORA	TEXAS MOUNTAIN LAUREL
SPARTIUM JUNCEUM	SPANISH BROOM
TECOMA STANS VAR. ANGUSTATA	YELLOW BELLS
TECOMA X ALATA	ORANGE JUBILEE
TRACHYCARPUS FORTUNEI	WINDMILL PALM
TRIXIS CALIFORNICA	TRIXIS
UNGNADIA SPECIOSA	MEXICAN BUCKEYE
VAUQUELINIA CALIFORNICA	ARIZONA ROSEWOOD
VAUQUELINIA CORYMBOSA V. HETERODON	MEXICO ROSEWOOD
VAUQUELINIA CORYMBOSA V. AUGUSTIFOLIA	CHISOS ROSEWOOD
VIGUIERA STENOLOBA	SKELETON LEAF
ZIZYPHUS OBTUSIFOLIA	GRAYTHORN
ACCENT PLANTS	
AGAVE SPECIES	CENTURY PLANT SELECTIONS
DASYLIRION SPECIES	SOTOL SELECTIONS
EPHEDRA SPECIES	JOINT FIR, MORMON TEA SELECTIONS
EUPHORBIA ANTISYPHILITICA	CANDELLIA
EUPHORBIA MYRSIRITES	BLUE SPURGE
EUPHORBIA RIGIDA (E. BIGLANDULOSA)	GOPHER PLANT
HECTIA TEXANA	FALSE AGAVE
HESPERALOE SPECIES	FALSE YUCCA SELECTIONS
JATROPHA DIOICA	LEATHERSTEM
NOLINA SPECIES	BEARGRASS SELECTIONS
OPUNTIA SPECIES	PRICKLEY PEAR, CHOLLA SELECTIONS
YUCCA SPECIES	YUCCA SELECTIONS
ORNAMENTAL GRASSES	
ARISTIDA PURPUREA	PURPLE THREEAWN
BOUTELOUA SPECIES	GRAMA GRASSES
MUHLENBERGIA SPECIES	MUHLEY GRASS SELECTIONS
NASSELLA TENNUISSIMA (STIPA TENNUISSIMA)	FEATHER GRASS
ORYZOPSIS HYMENOIDES	INDIAN RICE GRASS
PANICUM VIRGATUM	SWITCH GRASS SELECTIONS
PENNISETUM SETACEUM "RUBRUM"	RED / PURPLE FOUNTAIN GRASS
SCHIZACHRIUM SCOPARIUM	LITTLE BLUESTEM
SPOROBOLUS WRIGHTII	GIANT SACATON
TURF GRASSES	
BUCHLOE DACTYLOIDES	BUFFALOGRASS SELECTIONS
CYNODON DACTYLON	HYBRID BERMUDAGRASS SELECTIONS

# DRAFT

LOLIUM PERENNE	PERENNIAL RYE GRASS SELECTIONS
POA ARACHNIFERA	TEXAS BLUEGRASS
ZOYSIA SPECIES	ZOYSIA TURF SELECTIONS
GROUND COVERS	
ACACIA REDOLENS	PROSTRATE ACACIA
ACALYPHA MONOSTACHYA	COPPERLEAF
ARTEMISIA LUDOVICIANA	WHITE OR PRAIRIE SAGEBRUSH
BACCHARIS PILULARIS	COYOTE BUSH
BACCHARIS PILULARIS X SAROTHOIDES	DWARF COYOTE BUSH HYBRIDS
CARPOBROTUS CHILENSIS	CALIFORNIA ICE PLANT
CARPOBROTUS EDULIS	COMMON ICE PLANT
COTONEASTER GLAUCOPHYLLUS	GREY LEAFED COTONEASTER
COTONEASTER HORIZONTALIS	ROCK COTONEASTER
DALEA CAPITATA	LEMON DALEA
DALEA GREGGII	PROSTRATE OR TRAILING INDIGO BUSH
DELOSPERMA COOPERI	HARDY ICE PLANT
DELOSPERMA NUBIGENUM	HARDY YELLOW ICEPLANT
DICHONDRA ARGENTA	SILVER PONYFOOT
DROSANTHEMUM SPECIOSUM	ICE PLANT
GAZANIA RIGENS LEUCOLAENA	TRAILING GAZANIA
GLANDULARIA RIGIDA (VERBENA RIGIDA)	SANDPAPER VERBENA
GLANDULARIA PULCHELLA (VERBENA TENUISECTA)	MOSS VERBENA
JUNIPERUS HORIZONTALIS	JUNIPER GROUNDCOVER SELECTIONS
JUNIPERUS SABINA	JUNIPER GROUNDCOVER SELECTIONS
LANTANA MONTEVIDENSIS	TRAILING PURPLE
LANTANA X	LANATANA HYBRIDS
MAHONIA REPENS	CREEPING MAHONIA
MALEPORA CROCEA	RED ICEPLANT
MALEPORA LUTEA	YELLOW ICE PLANT
MARSILEA MACROPODA	FERN CLOVER
MIRABILIS MULTIFLORA	GIANT FOUR O'CLOCK
OENOTHERA SPECIOSA	MEXICAN PRIMROSE
OENOTHERA STUBBEI	BAJA EVENING PRIMROSE
PHYLA NODIFLORA VAR. INCISA	FROGFRUIT
TEUCRIUM X LUCIDRYS (T. CHAMADRYIS)	GERMANDER
TRACHELOSPERMUM JASMINOIDES	STAR JASMINE
TRACHELOSPERMUM ASIATICUM	ASIAN JASMINE
VINCA MAJOR	PERIWINKLE
VINCA MINOR	DWARF PERIWINKLE
ZINNIA GRANDIFLORA	PLAINS ZINNIA, ROCKY MOUNTAIN ZINNIA
VINES	
ANTIGONON LEPTOPUS	CORAL VINE
CAMPSIS RADICANS	TRUMPET VINE
CISSUS TRIFOLIATA	ARIZONA GRAPE IVY
CLEMATIS DRUMMONDII	DESERT CLEMATIS
CLEMATIS LINGUSTICIFOLIA	WESTERN VIRGIN'S BOWER
FALLOPIA AUBERTII (POLYGONUM AUBERTII)	SILVER LACE VINE
GELSEMIUM SEMPERVIRENS	CAROLINA JESSAMINE

HEDERA SPECIES	IVY SELECTIONS
LONICERA JAPONICA	JAPANESE HONEYSUCKLE SELECTIONS
LONICERA SEMPERVIRENS	CORAL HONEYSUCKLE
MACFADYENA UNGUIS-CATI	YELLOW CATCLAW VINE
MASCAGNIA LILACINA	PURPLE ORCHID VINE
PARTHENOCISSUS INSERTA	WOODBINE
PARTHENOCISSUS QUINQUEFOLIA	VIRGINIA CREEPER
WISTERIA SINENSIS	CHINESE WISTERIA
COLOR PERENNIALS	
AGAPANTHUS AFRICANUS	LILY OF THE NILE
ALLIUM TUBEROSUM	GARLIC CHIVES
AQUILEGIA CHRYSANTHA	GOLDEN COLUMBINE
ARTEMISIA SCHMIDTIANA 'SILVERMOUND'	SILVERMOUND
ARTEMISIA X 'POWIS CASTLE'	ARTEMISIA HYBRID
ASCLEPIAS TUBEROSA	BUTTERFLY WEED
BAILEYA MULTIRADIATA	DESERT MARIGOLD
BERLANDIERA LYRATA	CHOCOLATE DAISY
BULBINE FRUTESCENS	BULBINE
CALLIRHOE INVOLUCRATA	WINECUPS
CALYLOPHUS HARTWEGII	SUN DROPS
CENTAUREA CINERARIA	DUSTY MILLER
CONOCLINIUM GREGGII (EUPATORIUM GREGGII)	BLUE MIST FLOWER
COREOPSIS LANCEOLATA	COREOPSIS
ECHINACEA PURPUREA	PURPLE CONEFLOWER
ENGELMANNIA PERISTENIA	CUTLEAF DAISY
EPILOBIUM LATAFOLIUM (ZAUSCHNERIA LATAFOLIUM)	HUMMINGBIRD TRUMPET
ERYSIMUM HIERACIFOLIUM	SIBERIAN WALLFLOWER
GAILLARDIA ARISTATA	BLANKET FLOWER SELECTIONS
GAURA LINDHEIMERI	GAURA
GAZANIA X HYBRIDS	CLUMPING GAZANIA
GLANDULARIA GOODINGII (VERBENA GOODINGII)	GOODING VERBENA
HELIANTHUS MAXIMILIANI	MAXIMILIAN SUNFLOWER
HEMEROCALLIS SPECIES	DAYLILY SELECTIONS
HIBISCUS COULTERI	YELLOW DESERT MALLOW
IRIS SPECIES	IRIS SELECTIONS
LIATRIS PUNCTATA	GAYFEATHER
LINUM LEWISII	BLUE FLAX
LOBELIA CARDINALIS	CARDINAL FLOWER
LOBELIA LAXIFOLIA	LOOSE-FLOWERED LOBELIA
MALVAVISCUS DRUMMONDII (M. ARBOREUS)	TURK'S CAP
MELAMPODIUM LEUCANTHUM	BLACKFOOT DAISY
MENDORA LONGIFLORA	SHOWY MENDORA
MONARDA FISTULOSA VAR. MENTHIFOLIA	BEEBALM OR BERGAMOT
NIEREMBERGIA HIPPOMANICA	CUP FLOWER
OENOTHERA CAESPITOSA	TUFTED EVENING PRIMROSE
OENOTHERA MACROPODA (O. MISSOURIENSIS)	MISSOURI EVENING PRIMROSE
PAVONIA HASTATA	PINK PAVONIA
PAVONIA LASIOPETALA	ROSE PAVONIA
PENSTEMON AMBIGUUS	SAND OR PLAINS PENSTEMON

PENSTEMON AMPHELLOREA	MEXICAN PENSTEMON
PENSTEMON BACCHARIFOLIUS	ROCK PENSTEMON
PENSTEMON BARBATUS	SCARLET BUGLER
PENSTEMON CARDINALIS	CARDINAL PENSTEMON
PENSTEMON EATONII	FIRECRACKER PENSTEMON
PENSTEMON HAVARDII	HARVARD PENSTEMON
PENSTEMON PALMERI	PALMERS PENSTEMON
PENSTEMON PARRYI	PARRY'S PENSTEMON
PENSTEMON PSEUDOSPECTABILIS	CANYON PENSTEMON
PENSTEMON SUPERBUS	SUPERB PENSTEMON
PENSTEMON THURBERI	THURBERS PENSTEMON
PENSTEMON TRIFLORUS	HILL COUNTRY PENSTEMON
PENSTEMON WRIGHTII	WRIGHT'S PENSTEMON
PEROVSKIA ATRIPLICIFOLIA	RUSSIAN SAGE
PLUMBAGO AURICULATA	CAPE PLUMBAGO
PLUMBAGO SCANDENS	WHITE PLUMBAGO
PSILOSTROPHE TAGETINA	PAPER FLOWER
RATIBIDA COLUMNARIS	MEXICAN HAT OR CONEFLOWER
SALVIA CHAMAEDRYOIDES	MEXICAN BLUE SAGE
SALVIA FARINACEAE	MEALY BLUE SAGE
SALVIA LEUCANTHA	MEXICAN SAGE
SALVIA ROEMERIANA	CEDAR SAGE
SCUTELLARIA SUFFRUTESCENS	PINK SKULLCAP
SENECIO FLACCIDA	THREADLEAF GROUNDSEL
SPHAERALCEA AMBIGUA	GLOBE MALLOW
STACHYS COCCINEA	SCARLET HEDGENETTLE

# DIVISION 7: IRRIGATION STANDARDS

## Sec. 7.1 Title

This Chapter shall be known as the Irrigation Ordinance for the Horizon City TOD.

## Sec. 7.2 Valid License Required

Any person who connects an irrigation system to the water supply within the TOD area, must hold a valid license, as defined by Title 30, Texas Administrative Code, Chapter 30 and required by Chapter 1903 of the Texas Occupations Code, or as defined by Chapter 365, Title 22 of the Texas Administrative Code and required by Chapter 1301 of the Texas Occupations Code.

Exemptions:

A property owner is not required to be licensed in accordance with Texas Occupations Code, Title 12, §1903.002(c)(1) if he or she is performing irrigation work in a building or on a premises owned or occupied by the person as the person's home. A home or property owner who installs an irrigation system must meet the standards contained in Title 30, Texas Administrative Code, Chapter 344 regarding spacing, water pressure, spraying water over impervious materials, rain or moisture shut-off devices or other technology, backflow prevention and isolation valves.

## Sec. 7.3 Permit Required

Any person installing an irrigation system within the TOD area is required to obtain a permit from the city. Any plan approved for a permit must be in compliance with the requirements of this chapter. For all projects in the TOD area, these guidelines shall apply and the normal city of Horizon landscape and irrigation shall not apply.

## Sec. 7.4 Backflow Prevention Methods and Devices

1. Any irrigation system that is connected to the potable water supply must be connected through a backflow prevention method approved by the Texas Commission on Environmental Quality (TCEQ). The backflow prevention device must be approved by the American Society of Sanitary Engineers; or the Foundation for Cross-Connection Control and Hydraulic Research, University of Southern California; or the International Plumbing Code; or any other laboratory that has equivalent capabilities for both the laboratory and field evaluation of backflow prevention assemblies. The backflow prevention device must be installed in accordance with the laboratory approval standards or if the approval does not include specific installation information, the manufacturer's current published

recommendations. As an example, a FEBCO 825Y may be used for commercial projects and a FEBCO 765Y may be used for residential projects.

2. If conditions that present a health hazard exist, one of the following methods must be used to prevent backflow;
  - a. Reduced pressure principle backflow prevention assemblies may be used if:
    - (1) the device is installed at a minimum of 12 inches above ground in a location that will ensure that the assembly will not be submerged; and
    - (2) drainage is provided for any water that may be discharged through the assembly relief valve.
  - b. Pressure vacuum breakers may be used if:
    - (1) no back-pressure condition will occur; and
    - (2) the device is installed at a minimum of 12 inches above any downstream piping and the highest downstream opening. Pop-up sprinklers are measured from the retracted position from the top of the sprinkler.
3. Backflow prevention devices used in applications designated as health hazards must be tested upon installation and annually thereafter.
4. If an existing irrigation system without a backflow-prevention assembly requires major maintenance, alteration, repair or service, the system must be connected to the potable water supply through an approved, properly installed backflow prevention method before any major maintenance, alteration, repair or service is performed.
5. If an irrigation system is connected to a potable water supply through a pressure vacuum breaker or reduced pressure principle backflow assembly and includes an automatic master valve on the system, the automatic master valve must be installed on the discharge side of the backflow prevention assembly.
6. The irrigation shall ensure the backflow prevention device is tested by a licensed Backflow Prevention Assembly Tester prior to being placed in service and the test results provided to the local water purveyor and the irrigation system's owner or owner's representative within ten business days of testing of the backflow prevention device

## Sec. 7.5 Specific Conditions and Cross-Connection Control

1. Before any chemical is added to an irrigation system connected to the potable water supply, the irrigation



system must be connected through a reduced pressure principle backflow prevention assembly or air gap.

2. Connection of any additional water source to an irrigation system that is connected to the potable water supply can only be done if the irrigation system is connected to the potable water supply through a reduced-pressure principle backflow prevention assembly or an air gap.
3. Irrigation system components with chemical additives induced by aspiration, injection, or emission system connected to any potable water supply must be connected through a reduced pressure principle backflow device.

### Sec. 7.6 Water Conservation

All irrigation systems shall be designed, installed, maintained, altered, repaired, serviced and operated in a manner that will promote water conservation as defined in the Definitions section of this ordinance.

### Sec. 7.7 Irrigation Plans Required

1. Projects that are subject to the requirements of this chapter, shall require submission of separate plans for landscaping and irrigation. The irrigation plan shall be designed and sealed by one of the following:
  - a. An irrigator who holds a license issued by the Texas Commission on Environmental Quality under Chapter 37, Texas Water Code; or
  - b. An architect registered in the State of Texas, to the extent the architect’s acts are incidental to the pursuit of the architect’s profession; or
  - c. An engineer licensed in the State of Texas, to the extent the engineer’s acts are incidental to the pursuit of the engineer’s profession; or
  - d. A landscape architect who holds a certificate of registration issued pursuant to State Occupations Code Chapter 1052, to the extent the landscape architect’s acts are incidental to the pursuit of the landscape architect’s profession.
2. The design professional shall prepare an irrigation plan for each site where a new irrigation system will be installed. A paper copy of the irrigation plan must be on the job site at all times during the installation of the irrigation system. A drawing showing the actual installation of the system is due to each irrigation system. A drawing showing the actual installation of the system is due to each irrigation system owner after all new irrigation system installations. During the installation of the irrigation system, variances from the original plan may be authorized by the design professional if the variance from the plan does not:
  - a. Diminish the operational integrity of the irrigation system;

- b. Violate any requirements of this ordinance; and
- c. Go unnoted in red on the irrigation plan.
3. All irrigation plans used for construction must be drawn to scale and must include complete coverage of the area to be irrigated. The plan must include, at a minimum, the following information:
  - a. The irrigator’s seal, signature, and date of signing;
  - b. All major physical features and the boundaries of the areas to be watered;
  - c. A North arrow;
  - d. A legend;
  - e. The zone flow measurement for each zone;
  - f. Location and type of each controller;
  - g. Location, type and size of each:
    - (1) Water source, such as, but not limited to a water meter and point(s) of connection;
    - (2) Backflow prevention device;
    - (3) Water emission device, including, but not limited to, spray heads, rotary sprinkler heads, quick-couplers, bubblers, drip, or micro-sprays;
    - (4) Valve, including but not limited to, zone valves, master valves, and isolation valves;
    - (5) Pressure regulation component; and
    - (6) Main line and lateral piping.
  - h. The scale used; and
  - i. The design pressure.

### Sec. 7.8 Irrigation Standards

1. Irrigation systems shall be installed in accordance with the standards and requirements of the irrigation equipment manufacturer, the Texas Commission on Environmental Quality, and the International Plumbing Code, and as may be amended, and all applicable regulations and laws.
2. The source of irrigation water, whether potable or reclaimed, as provided by the City of El Paso water utilities, shall be indicated on the irrigation plans.
3. When using a potable irrigation water source, an approved backflow prevention device shall be installed in accordance with the City of El Paso Plumbing Code.
4. No irrigation design or installation shall require the use of any component, including the water meter, in a way which exceeds the manufacturer’s published performance limitations for the component.
5. Spacing.
  - (1) The maximum spacing between emission devices must not exceed the manufacturer’s published radius or spacing of the device(s). The radius or spacing is determined by

referring to the manufacturer's published specifications for a specific emission device at a specific operating pressure.

- (2) New irrigation systems shall not utilize above-ground spray emission devices in residential or commercial landscapes that are less than forty-eight inches not including the impervious surfaces in either length or width and which contain impervious pedestrian or vehicular traffic surfaces along two or more perimeters. If pop-up sprays or rotary sprinkler heads are used in a new irrigation system, the sprinkler heads must direct flow away from any adjacent surface and shall not be installed closer than four inches from a hardscape, such as, but not limited to, a building foundation, fence, concrete, asphalt, pavers, or stones set with mortar.
  - (3) Narrow paved walkways, jogging paths or other small areas located in parks or other public areas may be exempted from this requirement if the runoff drains into a landscaped area.
6. Drip and spray systems shall:
    - a. Be placed on separate valves;
    - b. All components on drip systems shall be measured in gallons per hour.
  7. Wiring and sleeving:
    - a. All wire shall be direct burial. Multi-strand shall not be allowed for direct burial;
    - b. Irrigation piping and wiring installed under any hardscaped areas shall be within sleeving.
  8. Storm retention pond areas that are irrigated shall incorporate, in the design, separate valves for the basin and slope areas. A moisture sensor shall be installed in the basin.
  9. Water pressure. Emission devices must be installed to operate at the minimum and not above the maximum sprinkler head pressure as published by the manufacturer for the nozzle and head spacing that is used. Methods to achieve the water pressure requirements include, but are not limited to, flow control valves, a pressure regulator or pressure compensating spray heads.
  10. Piping. Piping in irrigation systems must be designed and installed so that the flow of water in the pipe will not exceed a velocity of five feet per second for polyvinyl chloride (PVC) pipe.
  11. Irrigation zones. Irrigation systems shall have separate zones based on plant material type, microclimate factors, topographic features, soil conditions, and hydrological requirements.
  12. Master valve. When provided, a master valve shall be installed on the discharge side of the backflow prevention device on all new installations.
  13. PVC pipe primer solvent. All new irrigation systems that are installed using PVC pipe and fittings shall be primed with a colored primer prior to applying the PVC cement in accordance with the International Plumbing Code (Section 605).
  14. Isolation valve. All new irrigation systems must include an isolation valve between the water meter and the backflow prevention device.
  15. Pipe installation standard.
    - a. If the manufacturer has not published specifications for depth coverage of piping, the piping must be installed to provide minimum depth coverage of twelve inches of select backfill, between the top of the pipe and the natural grade of the topsoil for PVC pipe. All portions of the irrigation system that fail to meet this standard must be noted on the irrigation plan. If the area being irrigated has rock at a depth of six inches or less, select backfill may be mounded over the pipe. Mounding must be noted on the irrigation plan and discussed with the irrigation system owner or owner's representative to address any safety issues.
    - b. All trenches and holes created during installation of an irrigation system must be backfilled and compacted to the original grade.
  16. Water contained within the piping of an irrigation system is deemed to be non-potable. No drinking or domestic water usage, such as, but not limited to, filling swimming pools or decorative fountains, shall be connected to an irrigation system. If a hose bib (an outdoor water faucet that has hose threads on the spout) is connected to an irrigation system for the purpose of providing supplemental water to an area, the hose bib must be installed using a quick coupler key on a quick coupler installed in a covered purple valve box and the hose bib and any hoses connected to the bib must be labeled "non-potable, not safe for drinking." An isolation valve must be installed upstream of a quick coupler connecting a hose bib to an irrigation system.
  17. Either a licensed irrigator or a licensed irrigation technician shall be on-site at all times while the landscape irrigation system is being installed. When an irrigator is not onsite, the irrigator shall be responsible for ensuring that a licensed irrigation technician is on-site to supervise the installation of the irrigation system.

## Sec. 7.9 Completion of Irrigation System Installation

Upon completion of the irrigation system, the irrigator or irrigation technician who provided supervision for the on-site installation shall be required to complete four items:

1. A final “walk through” with the irrigation system’s owner or the owner’s representative to explain the operation of the system;
2. The maintenance checklist on which the irrigator or irrigation technician shall obtain the signature of the irrigation system’s owner or owner’s representative and shall sign, date, and seal the checklist. If the irrigation system’s owner or owner’s representative is unwilling or unable to sign the maintenance checklist, the irrigator shall note the time and date of the refusal on the irrigation system’s owner or owner’s representative’s signature line. The irrigation system owner or owner’s representative will be given the original maintenance checklist and a duplicate copy of the maintenance checklist shall be maintained by the irrigator. The items on the maintenance checklist shall include but are not limited to:
  - (1) the manufacturer’s manual for the automatic controller;
  - (2) a seasonal (spring, summer, fall, winter) watering schedule based on either current/real time evapotranspiration or monthly historical reference evapotranspiration (historical ET) data, monthly effective rainfall estimates, plant landscape coefficient factors, and site factors;
  - (3) a list of components, such as the nozzle, or pump filters, and other such components; that require maintenance and the recommended frequency for the service; and
  - (4) the statement, “This irrigation system has been installed in accordance with all applicable state and local laws, ordinances, rules, regulations or orders. I have tested the system and determined that it has been installed according to the Irrigation Plan and is properly adjusted for the most efficient application of water at this time.”
3. A permanent sticker which contains the irrigator’s name, license number, company name, telephone number and the dates of the warranty period shall be affixed to each automatic controller installed by the irrigator or irrigation technician. The information

contained on the sticker must be printed with waterproof ink and include;

4. The irrigation plan indicating the actual installation of the system must be provided to the irrigation system’s owner or owner representative.

## Sec. 7.10 Maintenance, Alteration, Repair or Service of Irrigation Systems

- (1) The licensed irrigator is responsible for all work that the irrigator performed during the maintenance, alteration, repair or service of an irrigation system during the warranty period. The irrigator or business owner is not responsible for the professional negligence of any other irrigator who subsequently conducts any irrigation service on the same irrigation system.
- (2) All trenches and holes created during the maintenance, alteration, repair or service of an irrigation system must be returned to the original grade with compacted select backfill.
- (3) Colored PVC pipe primer solvent must be used on all pipes and fittings used in the maintenance, alteration, repair or service of an irrigation system in accordance with the International Plumbing Code (Section 605).
- (4) When maintenance, alteration, repair or service of an irrigation system involves excavation work at the water meter or backflow prevention device, an isolation valve shall be installed, if an isolation valve is not present.

## Sec. 7.11 Reclaimed Water

Reclaimed water may be utilized in landscape irrigation systems if:

- a. the irrigation system does not spray water across property lines that do not belong to the irrigation system’s owner;
- b. the irrigation system is installed using purple components;
- c. the domestic potable water line is connected using an air gap or a reduced pressure principle backflow prevention device, in accordance with Title 30, Texas Administrative Code, Section 290.47(i) (relating to Appendices);

- d. a minimum of an eight inch by eight inch sign, in English and Spanish, is prominently posted on / in the area that is being irrigated, that reads, “RECLAIMED WATER — DO NOT DRINK” and “AGUA DE RECUPERACION — NO BEBER”; and
- e. backflow prevention on the reclaimed water supply line shall be in accordance with the regulations of the city’s water provider.
- f. shall be approved by the El Paso Water Utilities before calling for a final inspection.

### Sec. 7.12 Advertisement Requirements

1. All vehicles used in the performance of irrigation installation, maintenance, alteration, repair, or service must display the irrigator’s license number in the form of “LI \_\_\_\_\_” in a contrasting color of block letters at least two inches high, on both sides of the vehicle.

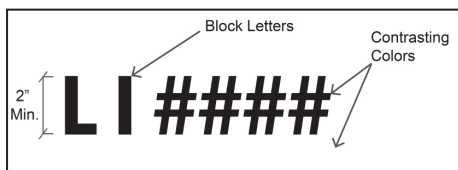

2. All forms of written and electronic advertisements for irrigation services must display the irrigator’s license number in the form of “LI \_\_\_\_\_.” Any form of advertisement, including business cards and estimates which displays an entity’s or individual’s name other than that of the licensed irrigator must also display the name of the licensed irrigator and the licensed irrigator’s license number. Trailers that advertise irrigation services must display the irrigator’s license number.
3. The name, mailing address and telephone number of the commission must be prominently displayed on a legible sign and displayed in plain view for the purpose of addressing complaints at the permanent structure where irrigation business is primarily conducted and irrigation records are kept.

### Sec. 7.13 Contracts

1. All contracts to install an irrigation system must be in writing and signed by each party and must specify the irrigator’s name, license number, business address, current business telephone numbers, the date that each party signed the agreement, the total agreed price and must contain the statement, “Irrigation in Texas is regulated by the Texas Commission on Environmental Quality (TCEQ), MC-178, P.O. Box 13087, Austin, Texas 78711-3087. TCEQ’s website is:

www.tceq.state.tx.us.” All contracts must include the irrigator’s seal, signature and date.

2. All written estimates, proposals, bids and invoices relating to the installation or repair of an irrigation system(s) must include the irrigator’s name, license number, business address, current business telephone number(s) and the statement: “Irrigation in Texas is regulated by the Texas Commission On Environmental Quality (TCEQ) (MC-178), P.O. Box 13087, Austin, Texas 78711-3087. TCEQ’s web site is: www.tceq.state.tx.us.”
3. An individual who agrees by contract to provide irrigation services as defined in Title 30, Texas Administrative Code, Section 344.30 (relating to License Required) shall hold an irrigator license issued under Title 30, Texas Administrative Code, Chapter 30 (relating to Occupational Licenses and Registrations) unless the contract is a pass-through contract as defined in Title 30, Texas Administrative Code, Section 344.1(36) (relating to Definitions). If a pass-through contract includes irrigation services, then the irrigation portion of the contract can only be performed by a licensed irrigator. If an irrigator installs a system pursuant to a pass-through contract, the irrigator shall still be responsible for providing the irrigation system’s owner or through contract, the irrigator shall still be responsible for providing the irrigation system’s owner or owner’s representative a copy of the warranty and all other documents required under this chapter. A pass-through contract must identify by name and license number the irrigator that will perform the work and must provide a mechanism for contacting the irrigator for irrigation system warranty work.
4. The contract must include the dates that the warranty is valid.

### Sec. 7.14 Warranties for Systems

1. On all installations of new irrigation systems, an irrigator shall present the irrigation system’s owner or owner’s representative with a written warranty covering materials and labor furnished in the new installation of the irrigation system. The irrigator shall be responsible for adhering to terms of the warranty. If the irrigator’s warranty is less than the manufacturer’s warranty for the system components, then the irrigator shall provide the irrigation system’s owner or the owner’s representative with applicable information regarding the manufacturer’s warranty period. The warranty must include the irrigator’s seal, signature and date. If the warranty is part of an irrigator’s contract, a separate warranty document is not required.
2. An irrigator’s written warranty on new irrigation systems must specify the irrigator’s name, business



address and business telephone number(s), must contain the signature of the irrigation system's owner or owner's representative confirming receipt of the warranty and must include the statement: "Irrigation in Texas is regulated by the Texas Commission on Environmental Quality (TCEQ), MC-178, P.O. Box 130897, Austin, Texas 78711-3087. TCEQ's website is: www.tceq.state.tx.us."

3. On all maintenance, alterations, repairs or service to existing irrigation systems, an irrigator shall present the irrigation system's owner or owner's representative a written document that identifies the materials furnished in the maintenance, alteration, repair or service. If a warranty is provided, the irrigator shall abide by the terms. The warranty document must include the irrigator's name and business contact information.

## Sec. 7.15 Duties and Responsibilities of City Inspectors

A city inspector shall enforce the ordinance of the TOD, and shall be responsible for:

1. verifying that the appropriate permits have been obtained for an irrigation system and that the irrigator and installer or irrigation technician, if applicable, are licensed;
2. inspecting the irrigation system;
3. determining that the irrigation system complies with the requirements of this chapter;
4. determining that the appropriate backflow prevention device was installed, tested and test results provided to the city;
5. investigating complaints related to irrigation system installation, maintenance, alteration, repairs, or service of an irrigation system and advertisement of irrigation services; and
6. maintaining records according to this chapter.

## Sec. 7.16 Items Not Covered By This Ordinance

Any item not covered by this ordinance and required by law shall be governed by the Texas Occupations Code, the Texas Water Code, Title 30 of the Texas Administrative Code and any other applicable state statute or Texas Commission on Environmental Quality rule.

## Sec. 7.17 Enforcement

1. The city shall have the power to administer and enforce the provisions of this chapter as may be required by governing law. Any person, firm, corporation or agent who shall violate a provision of

this Code, or fails to comply therewith, or with any of the requirements thereof, is subject to suit for injunctive relief as well as prosecution for criminal violations. Any violation of the ordinance codified in this chapter is declared to be a nuisance.

2. Any person violating any provision of chapter shall, upon conviction, be fined a sum not exceeding \$2,000. Each day that a provision of this chapter is violated shall constitute a separate offense. An offense under this chapter is a misdemeanor, punishable by a fine of up to \$2,000.
3. Nothing in this chapter shall be construed as a waiver of the city's right to bring a civil action to enforce the provisions of this chapter and to seek remedies as allowed by law, including, but not limited to the following: Injunctive relief to prevent specific conduct that violates the ordinance or to require specific conduct that is necessary for compliance with the ordinance; and other available relief.

## Sec. 7.18 Definitions

The following words and terms, when used in this ordinance, have the following meanings, unless the context clearly indicates otherwise.

4. Backflow prevention—The mechanical prevention of reverse flow, whether back pressure or back siphonage, of non-potable water from an irrigation system into the potable water source.
5. Backflow prevention assembly—Any assembly used to prevent backflow into a potable water system. The type of assembly used is based on the existing or potential degree of health hazard and backflow condition.
6. Completion of irrigation system installation—When the landscape irrigation system has been installed, all minimum standards met, all tests performed and the irrigator is satisfied that the system is operating correctly.
7. Consulting—The act of providing advice, guidance, review or recommendations related to landscape irrigation systems.
8. Cross-connection—An actual or potential connection between a potable water source and an irrigation system that may contain contaminants or pollutants or any source of water that has been treated to a lesser degree in the treatment process.
9. Design—The act of determining the various elements of a landscape irrigation system that will include, but not be limited to, elements such as collecting site specific information, defining the scope of the project, defining plant watering needs, selecting and laying out emission devices, locating system components, conducting hydraulics

- calculations, identifying any local regulatory requirements, or scheduling irrigation work at a site. Completion of the various components will result in an irrigation plan.
10. Design pressure—The pressure that is required for an emission device to operate properly. Design pressure is calculated by adding the operating pressure necessary at an emission device to the total of all pressure losses accumulated from an emission device to the water source.
  11. Emission device—Any device that is contained within an irrigation system and that is used to apply water. Common emission devices in an irrigation system include, but are not limited to, spray and rotary sprinkler heads and drip irrigation emitters.
  12. Employed—Engaged or hired to provide consulting services or perform any activity relating to the sale, design, installation, maintenance, alteration, repair or service to irrigation systems. A person is employed if that person is in an employer-employee relationship as defined by Internal Revenue Code, 26 United States Code Service, §3212(d) based on the behavioral control, financial control and the type of relationship involved in performing employment related tasks.
  13. Head-to-head spacing—The spacing of spray or rotary heads equal to the manufacturer’s published radius of the head.
  14. Health hazard—A cross-connection or potential cross-connection with an irrigation system that involves any substance that may, if introduced into the potable water supply, cause death or illness, spread disease, or have a high probability of causing such effects.
  15. Hydraulics—The science of dynamic and static water; the mathematical computation of determining pressure losses and pressure requirements of an irrigation system.
  16. Inspector—A licensed plumbing inspector, water district operator, other governmental entity, or irrigation inspector who inspects irrigation systems and performs other enforcement duties for a municipality or water district as an employee or as a contractor.
  17. Installer—A person who actually connects an irrigation system to a private or public raw or potable water supply system or any water supply, who is licensed according to Title 30, Texas Administrative Code, Chapter 30 (relating to Occupational Licenses and Registrations).
  18. Irrigation inspector—A person who inspects irrigation systems and performs other enforcement duties for a municipality or water district as an employee or as a contractor and is required to be licensed under Title 30, Texas Administrative Code, Chapter 30 (relating to Occupational Licenses and Registrations).
  19. Irrigation plan—A scaled drawing of a landscape irrigation system which lists required information, the scope of the project, and represents the changes made in the installation of the irrigation system.
  20. Irrigation services—Selling, designing, installing, maintaining, altering, repairing, servicing, permitting, providing consulting services regarding, or connecting an irrigation system to a water supply.
  21. Irrigation system—An assembly of component parts that is permanently installed for the controlled distribution and conservation of water to irrigate any type of landscape vegetation in any location, and / or to reduce dust or control erosion. This term does not include a system that is used on or by an agricultural operation as defined by Texas Agricultural Code, §251.002.
  22. Irrigation technician—A person who works under the supervision of a licensed irrigator to install, maintain, alter, repair, service or supervise installation of an irrigation system, including the connection of such system in or to a private or public, raw or potable water supply system or any water supply, and who is required to be licensed under Title 30, Texas Administrative Code, Chapter 30 (relating to Occupational Licenses and Registrations).
  23. Irrigation zone—A subdivision of an irrigation system with a precipitation rate based on plant material type (such as turf, shrubs, or trees), microclimate factors (such as sun / shade ratio), topographic features (such as slope) and soil conditions (such as sand, loam, clay or combination) or for hydrological control.
  24. Irrigator—A person who sells, designs, offers consultations regarding, installs, maintains, alters, repairs, services or supervises the installation of an irrigation system, including the connection of such system to a private or public, raw or potable water supply system or any water supply and who is required to be licensed under Title 30, Texas Administrative Code, Chapter 30.
  25. Irrigator-in-Change—The irrigator responsible for all irrigation work performed by an exempt business owner, including, but not limited to obtaining permits, developing design plans, supervising the work of other irrigators or irrigation technicians, and installing, selling, maintaining, altering, repairing, or servicing a landscape irrigation system.
  26. Landscape irrigation—The science of applying the necessary amount of water to promote or sustain



- healthy growth of plant material or turf.
27. License—An occupational license that is issued by the Texas Commission on Environmental Quality under Title 30, Texas Administrative Code, Chapter 30 to an individual that authorizes the individual to engage in an activity that is covered by Title 30, Texas Administrative Code, Chapter 30.
  28. Mainline—A pipe within an irrigation system that delivers water from the water source to the individual zone valves.
  29. Maintenance checklist—A document made available to the irrigation system’s owner or owner’s representative that contains information regarding the operation and maintenance of the irrigation system, including, but not limited to: checking and repairing the irrigation system, setting the automatic controller, checking the rain or moisture sensor, cleaning filters, pruning grass and plants away from irrigation emitters, using and operating the irrigation system, the precipitation rates of each irrigation zone within the system, any water conservation measures currently in effect from the water purveyor, the name of the water purveyor, a suggested seasonal or monthly watering schedule based on current evapotranspiration data for the geographic region, and the minimum water requirements for the plant material in each zone based on the soil type and plant material where the system is installed.
  30. Major maintenance, alteration, repair, or service—Any activity that involves opening to the atmosphere the irrigation main line at any point prior to the discharge side of any irrigation zone control valve. This includes, but is not limited to, repairing or connecting into a main supply pipe, replacing a zone control valve, or repairing a zone control valve in a manner that opens the system to the atmosphere.
  31. Master valve—A remote control valve located after the backflow prevention device that controls the flow of water to the irrigation system mainline.
  32. Matched precipitation rate—The condition in which all sprinkler heads within an irrigation zone apply water at the same rate.
  33. New installation—An irrigation system installed at a location where one did not previously exist.
  34. Pass-through contract—A written contract between a contractor or builder and a licensed irrigator or exempt business owner to perform part or all of the irrigation services relating to an irrigation system.
  35. Potable water—Water that is suitable for human consumption.
  36. Pressure Vacuum Breaker—An assembly containing an independently operating internally loaded check valve and an independently operating loaded air inlet valve located on the discharge side of the check valve. Also known as a Pressure Vacuum Breaker Back-siphonage Prevention Assembly.
  37. Reclaimed water—Domestic or municipal wastewater which has been treated to a quality suitable for beneficial use, such as landscape irrigation.
  38. Records of landscape irrigation activities—The irrigation plans, contracts, warranty information, invoices, copies of permits and other documents that relate to the installation, maintenance, alteration, repair, or service of a landscape irrigation system.
  39. Reduced Pressure Principle Backflow Prevention Assembly—An assembly containing two independently acting approved check valves together with a hydraulically operating mechanically independent pressure differential relief valve located between the two check valves and below the first check valve.
  40. Static water pressure—The pressure of water when it is not moving.
  41. Supervision—The on-the-job oversight and direction by a licensed irrigator who is fulfilling his or her professional responsibility to the client and / or employer in compliance with local or state requirements. Also, a licensed installer working under the direction of a licensed irrigator or an irrigation technician who is working under the direction of a licensed irrigator to install, maintain, alter, repair or service an irrigation system.
  42. Water conservation—The design, installation, service and operation of an irrigation system in a manner that prevents the waste of water, promotes the most efficient use of water, and applies the least amount of water that is required to maintain healthy individual plant material or turf, reduce dust and control erosion.
  43. Zone flow—A measurement, in gallons per minute or gallons per hour, of the actual flow of water through a zone valve, calculated by individually opening each zone valve and obtaining a valid reading after the pressure has stabilized. For design purposes, the zone flow is the total flow of all nozzles in the zone at a specific pressure.
  44. Zone valve—An automatic valve that controls a single zone of a landscape irrigation system.

# DIVISION 8: DEVELOPMENT REVIEW PROCEDURE

## Sec. 8.1 Purpose

**Sec. 8.1.A.** The purpose of this division is to provide development review procedures and standards for implementation and development of parcels in the Horizon City TOD.

**Sec. 8.1.B.** The development review process established in this Division is applicable to all proposed development activity within the Horizon City TOD.

**Sec. 8.1.C.** No development, including but not limited to grading, clearing of land, excavation of soil, or alteration of vegetation, shall be commenced or undertaken in the Horizon City TOD that is inconsistent with the City of Horizon's Municipal Code of Ordinances (Code). It shall at all times be the applicant's responsibility to demonstrate consistency with the goals, objectives, policies, and provisions of the Code and the Horizon City TOD.

## Sec. 8.2 Application

**Sec. 8.2.A.** All development within the Horizon City TOD requires an application Master Site Plan Review and Approval. Applications are to be submitted to the City's Planning Department in an electronic form to be provided to the City.

**Sec. 8.2.B.** Approval for a Master Site Plan shall not constitute approval to build or construct any improvements and is not the final approval necessary for construction of the development.

**Sec. 8.2.C.** Approval of the Master Site Plan shall authorize the applicant to submit building permit applications in accordance with the terms and conditions of the approval and after having satisfied all platting requirements. Permission to initiate construction of site improvements shall not be granted or building permits issued until all required documents are executed and all applicable conditions of approval satisfied as per the City's development standards.

**Sec. 8.2.D.** The Development Process and Approval of the Master Site Plan shall be handled administratively by the Planning Director or her designee. Approval shall be given within 10 working days upon acceptance of a completed application.

## Sec. 8.3 Master Site Plans

**Sec. 8.3.A.** The land area encompassed by a Master Site Plan shall be the minimum area as outlined in the Horizon TOD. The following documents must be submitted by the applicant to the Planning Director for review and approval:

1. Illustrative plan that is "to scale" and clearly illustrates development standards that are in conformance to the TOD Zoning District. These shall include building placement, building setbacks, building form, lot and block standards, frontage types, parking standards, landscaping, and civic spaces if applicable.
2. Transect plan showing the lot, block, and street network and allocation of Zoning District as outlined in the Horizon TOD;
3. Streets atlas showing the Street Thoroughfare locations and Street Types as outlined in the Horizon TOD.
4. Stormwater management plan;
5. Illustrations that depict the proposed scale and character or the development of the area as outlined in the Horizon TOD.

**Sec. 8.3.B.** Applications for City approval of Master Site Plans shall be subject to the following:

1. A letter of approval and all documents and plans reviewed and approved by the Planning Director shall be submitted along with the development application to the City for review.
2. The application shall be filed with the City Planning Department by the owner or other person providing an affidavit to act as agent for the owner.
3. Proof of ownership and tax certificate showing no balance due is required.
4. The application shall be submitted in a form approved by the City Administrator and made available to the public. At a minimum, it shall include sufficiently detailed and documented information for staff to make the required findings of compliance. All applications shall include a checklist provided by the City specific to Master Site Plan applications, submitted in accordance with the Horizon TOD.
5. Application fees shall be waived for projects in the Horizon City TOD.

**Sec. 8.3.C.** If a Master Site Plan application approval requires changes to the Horizon City TOD, the applicant shall address such changes within the application materials submitted with the Master Site Plan application. The change to the Horizon City TOD, shall require approval of an amendment by the City Council, unless the change qualifies as a Warrant.

Sec. 8.3.D. Applications will be reviewed for completeness within 5 working days. Applications deemed incomplete will be returned to the applicant with a letter outlining the deficiencies that need to be addressed for review.

Sec. 8.3.E. The Planning Director shall prepare a report within 20 working days of transmittal which addresses all of the requirements of the TOD, and the Code.

Sec. 8.3.F. Upon a finding of noncompliance, a resubmittal of requested materials shall be made within 30 working days of the issuance of the staff report. If the applicant fails to meet the resubmittal deadline, the application shall be terminated, unless the applicant gives notice that an elective resubmittal will be made. The elective resubmittal shall be made within 90 days from the date the prior resubmittal was due. All documents that have expired must be updated by the applicant. Upon receipt of the resubmittal, staff will have 20 working days to review and provide comments.

Sec. 8.3.G. Upon findings of compliance with the TOD and the Code, the development application shall be deemed approved by the Planning Director.

Sec. 8.3.H. An approved Master Site Plan is valid for ten (10) years.

## Sec. 8.4 Warrants, Exceptions, and Amendments

Sec. 8.4.A. This section provides a mechanism by which a proposed development may vary from the requirements of Horizon City TOD of this TOD. This section also provides for amendment of approved Master Site Plans. The intent of this section is to provide flexibility for unusual situations and to provide alternative ways to meet the purposes of this TOD, while ensuring that the TOD realizes the vision and intent sought by the Horizon TOD.

Sec. 8.4.B. Any proposed variation from the requirements of this TOD shall be reviewed by the Planning Director. If the proposed development is consistent with the intended purpose of this TOD the Director may:

1. Issue a Warrant allowing a variation from the requirements of Horizon TOD Zoning District; or
2. Recommend that the City Commission approve an Exception allowing a variation from the requirements of the TOD; or
3. Recommend that the Horizon TOD be amended, pursuant to City regulations.

 8.4.C. Warrants may be approved by the City Administrator for the following:

1. The allowance of a use not listed in the Table of Permitted Uses, upon a finding that the use is functionally similar to the permitted uses and that the use is not likely to generate harmful impacts or create incompatibilities with other uses in the Neighborhood.
2. Modifications of a requirement of Design Standards of the Horizon TOD to accommodate circumstances such as natural features, access requirements related to fire and life safety, and site designs that demonstrate excellent urban design or architectural merit.

Sec. 8.4.D. Exceptions for proposed Master Site Plans may be approved by the Planning & Zoning Commission for the following:

1. Variation of up to 10% change in criteria found in Design Standards of the Zoning District.
2. Realignment and/or reconfiguration of the street network that does not change the proposed number of intersections or the Horizon TOD.

### Sec. 8.4.E. Amendments to TOD

1. Unless a proposed change qualifies as a Warrant or an Exception, changes to the Permitted Use Table, other provisions of the TOD, and the Regulating Plan shall require consideration by the Planning & Zoning Commission and the City Council, pursuant to the Code.

### Sec. 8.4.F. Amendments to Approved Site Plans

1. The Planning Director may approve minor or technical changes to approved Master Site Plans in accordance with the Code.
2. A proposed amendment of a Master Site Plan that does not qualify as a minor or technical change shall require the approval of the Planning & Zoning Commission.
3. The Planning Director may approve minor or technical changes to Master Site Plan including changes that do not affect compliance with the TOD or require changes to permits from outside agencies. All other amendments to Final Site Plans shall require review pursuant to Sec 8.4 of this code.

Sec. 8.4.G. An application for a Warrant, Exception, or amendment, shall include a letter of approval from the Planning Director. The application shall be submitted on an electronic form approved by the City Planning Department and made available to the public. Each application shall

be accompanied by the application fee established by resolution of the City Council.

**Sec. 8.4.H.** The Planning Director shall keep a record of all Warrants and Exceptions granted.

**Sec. 8.4.I.** Warrants and Exceptions shall not be issued for the following:

1. ~~Street or Alley dimensions and~~ required infrastructure
2. Parking locations
3. Building Height
4. Protection of wetlands, upland native habitat, and listed species
5. Preserve area requirements

## **Sec. 8.5 Inspection**

**Sec. 8.5.A.** Any member of the City Council and any duly authorized representative of the City Council, such as, but not limited to, staff of the Public Works Department, may enter and inspect any parcel of land for which a development approval or permit has been issued, or where there is a reasonable cause to believe that a development activity is being carried out, for the purpose of ascertaining the state of compliance with the Code. The interiors of buildings shall not be subject to such inspections unless related to the enforcement of the building code. No person shall refuse immediate entry or access to any authorized representative of the City Council or one of the specified agencies who requests entry for the purpose of inspection and who presents appropriate credentials. No person shall obstruct, hamper or interfere with any such inspection. If requested, the owner or operator of the premises shall receive a report setting forth the facts and results of the compliance determination.